



Extracts from the Register of Copyrights



प्रतिलिप्यधिकार कार्यालय, भारत सरकार | Copyright Office, Government Of India

दिनांक/Dated:26/09/2023

- पंजीकरण संख्या/Registration Number : **L-133638/2023**
- आवेदक का नाम, पता तथा राष्ट्रीयता
Name, address and nationality of the applicant : **DR.PERUMAL P , 2/164,BALEGULI VILLAGE,KRISHNAGIRI DISTRICT,TAMILNADU,INDIA-635204 INDIAN**
- कृति के प्रतिलिप्यधिकार में आवेदक के हित की प्रकृति
Nature of the applicant's interest in the copyright of the work : **AUTHOR**
- कृति का वर्ग और वर्णन
Class and description of the work : **LITERARY/ DRAMATIC WORK CREATING A NEW LATERAL PERCUTANEOUS INCISION TECHNIQUE FOR TRADITIONAL AUTOPSIES, SEEKING TO ENHANCE PROCEDURAL EFFICIENCY, MINIMIZE INVASIVENESS, AND SATISFACTION FOR DOCTORS & DEAD PERSON FAMILY**
- कृति का शीर्षक
Title of the work : **MAKING AN INNOVATIVE LATERAL PERCUTANEOUS (LP) INCISION TO DO A TRADITIONAL AUTOPSY**
- कृति की भाषा
Language of the work : **ENGLISH**
- रचयिता का नाम, पता और राष्ट्रीयता तथा यदि रचयिता की मृत्यु हो गई है, तो मृत्यु की तिथि
Name, address and nationality of the author and if the author is deceased, date of his decease : **DR.PERUMAL P , 2/164,BALEGULI VILLAGE,KRISHNAGIRI DISTRICT,TAMILNADU,INDIA-635204 INDIAN**
- कृति प्रकाशित है या अप्रकाशित
Whether the work is published or unpublished : **UNPUBLISHED**
- प्रथम प्रकाशन का वर्ष और देश तथा प्रकाशक का नाम, पता और राष्ट्रीयता
Year and country of first publication and name, address and nationality of the publisher : **N.A.**
- बाद के प्रकाशनों के वर्ष और देश, यदि कोई हों, और प्रकाशकों के नाम, पते और राष्ट्रीयताएँ
Years and countries of subsequent publications, if any, and names, addresses and nationalities of the publishers : **N.A.**
- कृति में प्रतिलिप्यधिकार सहित विभिन्न अधिकारों के स्वामियों के नाम, पते और राष्ट्रीयताएँ और समनुदेशन और अनुज्ञापितियों के विवरण के साथ प्रत्येक के अधिकार का विस्तार, यदि कोई हो।
Names, addresses and nationalities of the owners of various rights comprising the copyright in the work and the extent of rights held by each, together with particulars of assignments and licences, if any : **DR.PERUMAL P , 2/164,BALEGULI VILLAGE,KRISHNAGIRI DISTRICT,TAMILNADU,INDIA-635204 INDIAN**
- अन्य व्यक्तियों के नाम, पते और राष्ट्रीयताएँ, यदि कोई हों, जो प्रतिलिप्यधिकार वाले अधिकारों को समनुदेशित करने या अनुज्ञापित देने के लिए अधिकृत हों
Names, addresses and nationalities of other persons, if any, authorised to assign or licence of rights comprising the copyright : **DR.PERUMAL P , 2/164,BALEGULI VILLAGE,KRISHNAGIRI DISTRICT,TAMILNADU,INDIA-635204 INDIAN**
- यदि कृति एक 'कलात्मक कृति' है, तो कृति पर अधिकार रखने वाले व्यक्ति का नाम, पता और राष्ट्रीयता सहित मूल कृति का स्थान। (एक वास्तुशिल्प कृति के मामले में कृति पूरी होने का वर्ष भी दिखाया जाना चाहिए)
If the work is an 'Artistic work', the location of the original work, including name, address and nationality of the person in possession of the work. (In the case of an architectural work, the year of completion of the work should also be shown). : **N.A.**
- यदि कृति एक 'कलात्मक कृति' है जो किसी भी माल या सेवाओं के संबंध में उपयोग की जाती है या उपयोग किए जाने में सक्षम है, तो आवेदन में प्रतिलिप्यधिकार अधिनियम, 1957 की धारा 45 की उप-धारा (i) के प्रावधान के अनुसार व्यापार चिह्न रजिस्ट्रार से प्रमाणन शामिल होना चाहिए।
If the work is an 'Artistic work' which is used or capable of being used in relation to any goods or services, the application should include a certification from the Registrar of Trade Marks in terms of the provision to Sub-Section (i) of Section 45 of the Copyright Act, 1957. : **N.A.**
- यदि कृति एक 'कलात्मक कृति' है, तो क्या यह डिजाइन अधिनियम 2000 के अंतर्गत पंजीकृत है? यदि हाँ, तो विवरण दें।
If the work is an 'Artistic work', whether it is registered under the Designs Act 2000, if yes give details. : **N.A.**
- यदि कृति एक 'कलात्मक कृति' है, जो डिजाइन अधिनियम 2000 के तहत एक डिजाइन के रूप में पंजीकृत होने में सक्षम है, तो क्या यह औद्योगिक प्रक्रिया के माध्यम से किसी वस्तु पर प्रयुक्त की गई है और यदि हाँ, तो इसे कितनी बार पुनरुत्पादित किया गया है?
If the work is an 'Artistic work', capable of being registered as a design under the Designs Act 2000,whether it has been applied to an article though an industrial process and ,if yes ,the number of times it is reproduced. : **N.A.**
- टिप्पणी, यदि कोई हो/Remarks, if any

डायरी संख्या/Diary Number: 19602/2023-CO/L

आवेदन की तिथि/Date of Application: 26/07/2023

प्राप्ति की तिथि/Date of Receipt: 26/07/2023



Registrar of Copyrights

MAKING AN INNOVATIVE LATERAL PERCUTANEOUS (LP) INCISION TO DO A TRADITIONAL AUTOPSY

Author:

Dr. Perumal P, Dr Ravindra S Honnugar. Department of Forensic Medicine and Toxicology, Jawaharlal Nehru Medical college, KAHER, Belagavi, Karnataka-590010.

Email: perumalp632@gmail.com;

Phone : +91-9626755997.

Abstract:

Law enforcement agencies rely heavily on medico-legal autopsies to identify the deceased and establish the cause of death, time since death, and circumstances of their deaths. Traditional autopsy techniques, however, have the potential to leave the deceased with aesthetic defects and deformities, upsetting their family and possibly decreasing the effectiveness of the investigation. The autopsy procedure is improved by this literary presentation of a unique and new Lateral Percutaneous (LP) incision approach that reduces invasiveness while increasing visibility. The literary highlights the study's purpose and goals, which centre on developing a novel method for autopsies while emphasising procedural effectiveness and the satisfaction of both the medical community and the bereaved family. To evaluate the validity, effectiveness, and prospective advantages of the LP incision technique, the research's methods—including literature reviews, cadaver studies, and expert consultations—are reviewed.

Key words: Autopsy; Lateral Percutaneous incision; Cosmetics; Opinion.

Introduction:

Law enforcement agencies need medico-legal autopsies to help them investigate and solve situations involving mysterious deaths. However, due to the usage of confirming or releasing incisions during the autopsy examination, conventional autopsy skin incision techniques might produce observable defects and ugliness.¹ This literary work offers the idea of a novel Lateral Percutaneous (LP) incision technique

ditional autopsy to overcome these difficulties and enable optimum vision of the body without compromising aesthetics.



(Signature)

COPYRIGHT OFFICE
NEW DELHI
Reg. No. - L/133638/2023
Date 26/09/2023

Aim and Objectives:

I introduce a new method of skin incision for autopsy in this literary work - Lateral Percutaneous (LP) skin incision

1. Increasing Satisfaction: By keeping the body's look to the maximum extent feasible, the LP skin incision technique attempts to lessen the emotional load on the deceased's family.
2. Improving Procedural Efficiency: The LP skin incision seeks to improve procedural efficiency by streamlining the autopsy technique and allowing for a more systematic inspection while cutting down on the amount of time needed for the operation.
3. Reducing Invasiveness: The method uses a lateral percutaneous approach to lessen the level of physical damage and deformity, leading to a more courteous assessment.

COPYRIGHT OFFICE
NEW DELHI
Reg. No. - L-133638/2023
Date 26/09/2023

Methods:

1. Literature research: To comprehend current autopsy skin incision methods and recognise their shortcomings, a thorough literature research will be carried out - To reveal the underlying structures, the skin can be incised in a number of different methods. The Y-shaped incision, the modified Y-shaped incision, and the I-shaped incision are the three skin incisions that are used the most frequently.²
2. Design and Application: The LP skin incision technique will be devised and used in cadaveric tests to evaluate its feasibility and effect on visibility based on the findings from the research that was done.
3. Expert Consultations: To get important input and insights on the dependability and effectiveness of the LP skin incision procedure, forensic experts, pathologists, and medical specialists and other law authorities will be consulted.

The present study exclusively uses data from our institution. might limit the findings' ation in other institutions. An investigation of the authenticity of the new m's advantages is about to start. Institutional Ethics' approval is Not Applicable.



(Signature)

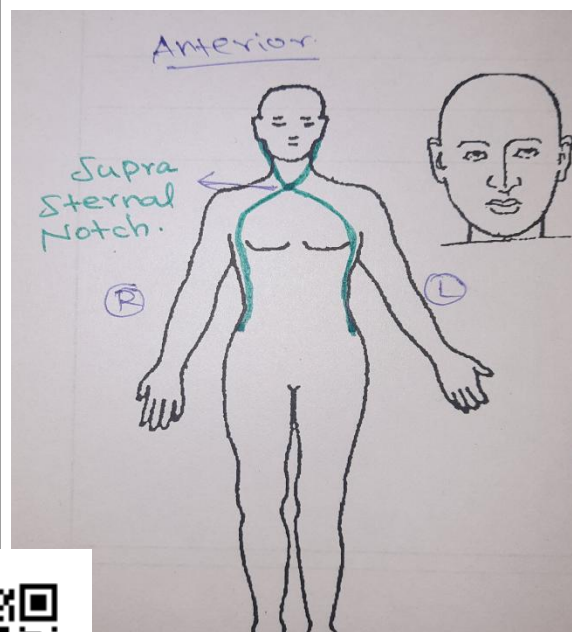
The care has been taken to disguise the identify of the deceased corpse since medicolegal autopsy in situations of unnatural deaths is mandatory in India and incisions must be done.

The list was produced after a thorough investigation of the anatomical landmarks of various types of incisions:

Image-1

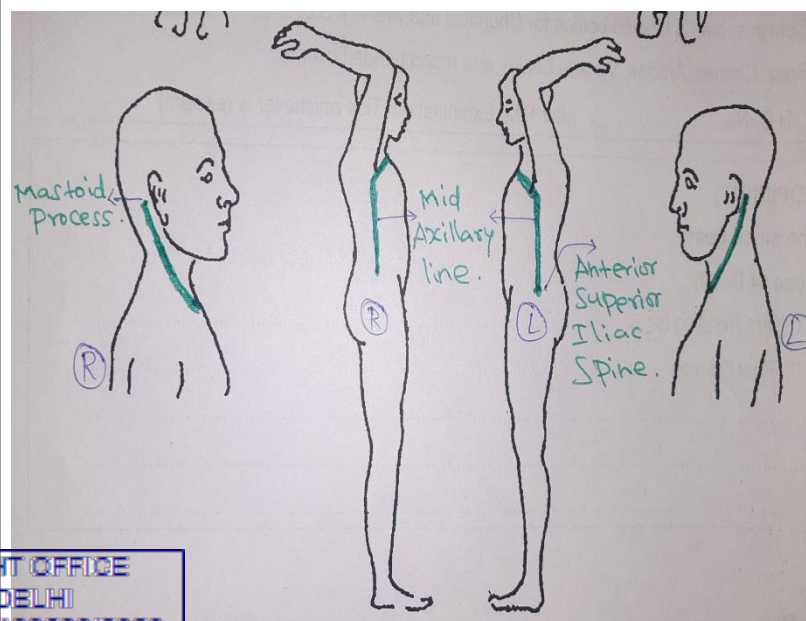


Image-2



Dr Perumal P

Image-3



COPYRIGHT OFFICE
NEW DELHI
Reg. No. - L-133638/2023
Date 26/09/2023

Results:

Release incisions are required for additional confirmation of entire exposure of the front of the neck and the inferior border of the lower jaw, separating a bruise from a hypostasis, and for evaluating the presence of bruising. Reassessing the wound tract in stabbing and gunshot injury after dissection is straightforward. uncomplicated in situations of surgical death as well since this skin incision does not interfere with iatrogenic surgical wounds.

Additional thoracic incisions, especially those at the front, are not necessary in LP incision. When viewed squarely in front of you, incisions on the neck and torso are less noticeable. Its routine usage is both feasible and beneficial for an autopsy on a female corpse, cases of death from torture committed while in imprisonment, lethal pressure on the neck. Our method encourages a single incision and is physically appealing, which benefits autopsy doctors and legal heirs.

We can see the following characteristics in our LP incision:

- Operational region accessible for evaluation without further incision and understandable - Complete



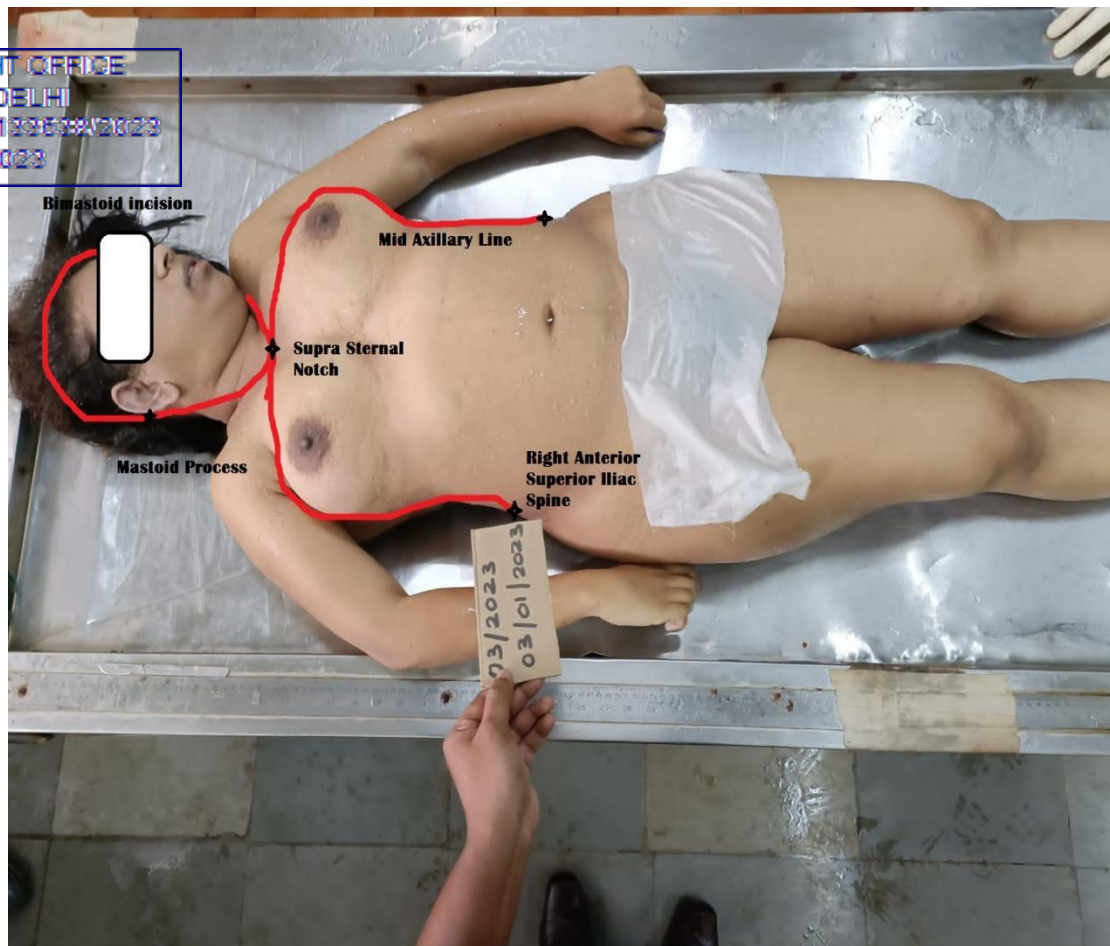
Signature

- Visible regenerated skin incision on the corpse's front - Less than conventional ("I"/"Y"/modified "Y")
- Stitching up the flap of abdominal muscle - Not necessary
- Requirement for further releases or confirming incisions - No Need
- Body fluid leakage during transfer - No
- Time required to stitch - More than traditional autopsy

The introducing, Lateral Percutaneous LP incision used in traditional autopsies is plainly seen in the photographs below:

Image-4

COPYRIGHT OFFICE
NEW DELHI
Reg. No. - L-1335/W/2023
Date 26/09/2023



Signature

Image-5

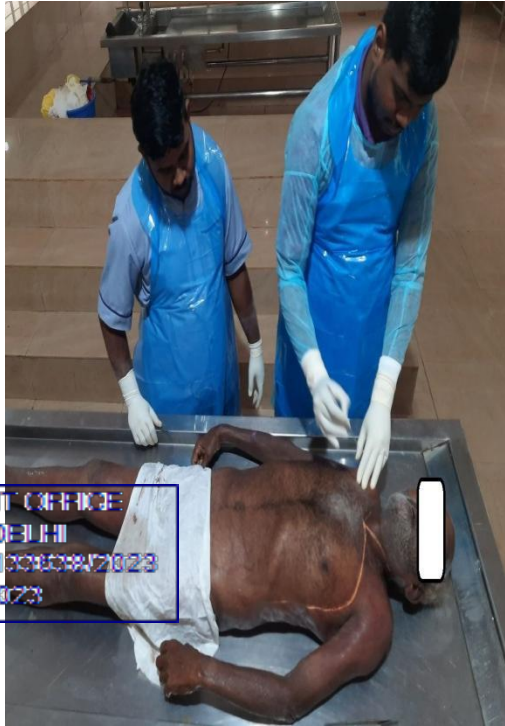


Image-6



Signature

Image-7



COPYRIGHT OFFICE
NEW DELHI
Reg. No. - L-10010047023
Date: 26/09/2023

Image-8



Signature

Image-9



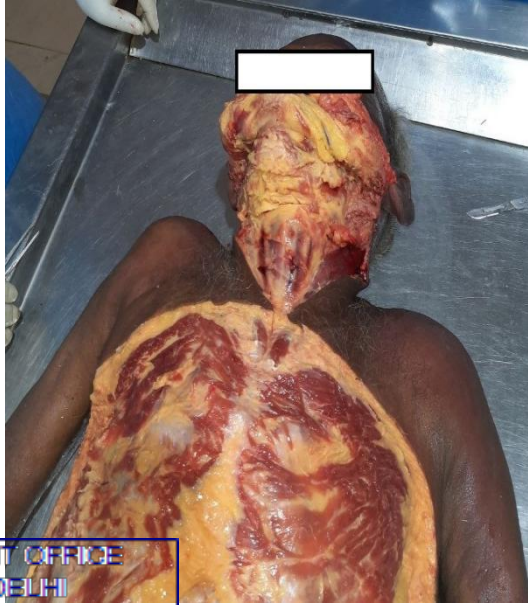
COPYRIGHT OFFICE
NEW DELHI
Reg. No. - L-133538/2023
Date 26/09/2023

Image-10



Signature

Image-11



COPYRIGHT OFFICE
NEW DELHI
Reg. No. - L-133538/2023
Date: 26/09/2023

Image-12. Suturing of LP incision



Signature

Image-13



COPYRIGHT OFFICE
NEW DELHI
Reg. No. - L-133638/2023
Date 26/09/2023

Conclusion:

The Lateral Percutaneous (LP) skin incision approach for medico-legal autopsies has the potential to revolutionise current autopsy practises if it is developed and used successfully. This ground-breaking method advances forensic medicine by emphasising procedural effectiveness, reducing invasiveness, and increasing satisfaction among medical professionals and the deceased's family. The findings of this study may have a favourable impact on autopsy procedures and help make medico-legal examinations more accurate and humane.

References:

- 1) Byard RW, Khong TY. Myths, misconceptions and the autopsy. Aust Fam Physician. 1997 May;26(5):555-7. PMID: 9170671.
- 2) Burton JL, Underwood J. Clinical, educational, and epidemiological value of autopsy. Lancet. 2007 Apr 28;369(9571):1471-1480. doi: 10.1016/S0140-6736(07)60376-6. PMID: 17467518.



20/09/23



ORIGINAL

मूल/No : 135112



भारत सरकार
GOVERNMENT OF INDIA
पेटेंट कार्यालय
THE PATENT OFFICE

डिजाइन के पंजीकरण का प्रमाणपत्र
CERTIFICATE OF REGISTRATION OF DESIGN

डिजाइन सं. / Design No. : 378989-001
तारीख / Date : 09/02/2023
पारस्परिकता तारीख / Reciprocity Date* :
देश / Country :

प्रमाणित किया जाता है कि संलग्न प्रति में वर्णित डिजाइन जो **METRIC DENTAL HOT PLATE** से संबंधित है, का पंजीकरण, श्रेणी **24-01** में **Rajesh Suhas Swami** के नाम में उपर्युक्त संख्या और तारीख में कर लिया गया है।

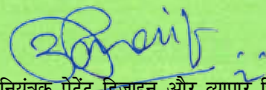
Certified that the design of which a copy is annexed hereto has been registered as of the number and date given above in class **24-01** in respect of the application of such design to **METRIC DENTAL HOT PLATE** in the name of Rajesh Suhas Swami.

डिजाइन अधिनियम, 2000 तथा डिजाइन नियम, 2001 के अध्याधीन प्रावधानों के अनुसरण में।

In pursuance of and subject to the provisions of the Designs Act, 2000 and the Designs Rules, 2001.

INTELLECTUAL
PROPERTY INDIA
PATENTS | DESIGNS | TRADE MARKS
GEOGRAPHICAL INDICATIONS

निर्गमन की तारीख/Date of Issue : 12/05/2023


महानियंत्रक पेटेंट डिजाइन और व्यापार चिह्न
Controller General of Patents, Designs and Trade Marks

पारस्परिकता तारीख (यदि कोई हो) जिसकी अनुमति देश के नाम पर की गई है। डिजाइन का सत्त्वाधिकार पंजीकरण की तारीख से दस वर्षों के लिए होगा जिसका विस्तार, अधिनियम एवं नियम के निबंधनों के अधीन, पाँच वर्षों की अतिरिक्त अवधि के लिए किया जा सकेगा। इस प्रमाण पत्र का उपयोग विधिक कार्यवाहियों अथवा विदेश में पंजीकरण प्राप्त करने के लिए नहीं हो सकता है।

*The reciprocity date (if any) which has been allowed and the name of the country. Copyright in the design will subsist for ten years from the date of Registration, and may under the terms of the Act and Rules, be extended for a further period of five years. This Certificate is not for use in legal proceedings or for obtaining registration abroad.



ORIGINAL

मूल/No : 135815



भारत सरकार
GOVERNMENT OF INDIA
पेटेंट कार्यालय
THE PATENT OFFICE

डिजाइन के पंजीकरण का प्रमाणपत्र
CERTIFICATE OF REGISTRATION OF DESIGN

डिजाइन सं. / Design No. : 378990-001
तारीख / Date : 09/02/2023
पारस्परिकता तारीख / Reciprocity Date* :
देश / Country :

प्रमाणित किया जाता है कि संलग्न प्रति में वर्णित डिजाइन जो **METRIC DENTAL WAX KNIFE** से संबंधित है, का पंजीकरण, श्रेणी **24-02** में **Rajesh Suhas Swami** के नाम में उपर्युक्त संख्या और तारीख में कर लिया गया है।

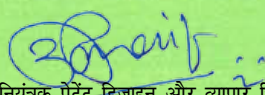
Certified that the design of which a copy is annexed hereto has been registered as of the number and date given above in class **24-02** in respect of the application of such design to **METRIC DENTAL WAX KNIFE** in the name of Rajesh Suhas Swami.

डिजाइन अधिनियम, 2000 तथा डिजाइन नियम, 2001 के अध्याधीन प्रावधानों के अनुसरण में।

In pursuance of and subject to the provisions of the Designs Act, 2000 and the Designs Rules, 2001.

INTELLECTUAL
PROPERTY INDIA
PATENTS | DESIGNS | TRADE MARKS
GEOGRAPHICAL INDICATIONS

निर्गमन की तारीख/Date of Issue : 17/05/2023


महानियंत्रक पेटेंट डिजाइन और व्यापार चिह्न
Controller General of Patents, Designs and Trade Marks

पारस्परिकता तारीख (यदि कोई हो) जिसकी अनुमति देश के नाम पर की गई है। डिजाइन का सत्त्वाधिकार पंजीकरण की तारीख से दस वर्षों के लिए होगा जिसका विस्तार, अधिनियम एवं नियम के निबंधनों के अधीन, पाँच वर्षों की अतिरिक्त अवधि के लिए किया जा सकेगा। इस प्रमाण पत्र का उपयोग विधिक कार्यवाहियों अथवा विदेश में पंजीकरण प्राप्त करने के लिए नहीं हो सकता है।

*The reciprocity date (if any) which has been allowed and the name of the country. Copyright in the design will subsist for ten years from the date of Registration, and may under the terms of the Act and Rules, be extended for a further period of five years. This Certificate is not for use in legal proceedings or for obtaining registration abroad.



ORIGINAL

मूल/No : 134371



भारत सरकार
GOVERNMENT OF INDIA
पेटेंट कार्यालय
THE PATENT OFFICE

डिजाइन के पंजीकरण का प्रमाणपत्र
CERTIFICATE OF REGISTRATION OF DESIGN

डिजाइन सं. / Design No. : 378991-001
तारीख / Date : 09/02/2023
पारस्परिकता तारीख / Reciprocity Date* :
देश / Country :

प्रमाणित किया जाता है कि संलग्न प्रति में वर्णित डिजाइन जो **DENTAL WAX SPOON** से संबंधित है, का पंजीकरण, श्रेणी **24-01** में **Rajesh Suhas Swami** के नाम में उपर्युक्त संख्या और तारीख में कर लिया गया है।

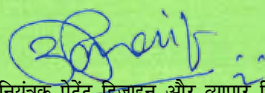
Certified that the design of which a copy is annexed hereto has been registered as of the number and date given above in class **24-01** in respect of the application of such design to **DENTAL WAX SPOON** in the name of Rajesh Suhas Swami.

डिजाइन अधिनियम, 2000 तथा डिजाइन नियम, 2001 के अध्याधीन प्रावधानों के अनुसरण में।

In pursuance of and subject to the provisions of the Designs Act, 2000 and the Designs Rules, 2001.

INTELLECTUAL
PROPERTY INDIA
PATENTS | DESIGNS | TRADE MARKS
GEOGRAPHICAL INDICATIONS

निर्गमन की तारीख/Date of Issue : 04/05/2023


महानियंत्रक पेटेंट डिजाइन और व्यापार चिह्न
Controller General of Patents, Designs and Trade Marks

पारस्परिकता तारीख (यदि कोई हो) जिसकी अनुमति देश के नाम पर की गई है। डिजाइन का सत्त्वाधिकार पंजीकरण की तारीख से दस वर्षों के लिए होगा जिसका विस्तार, अधिनियम एवं नियम के निबंधनों के अधीन, पाँच वर्षों की अतिरिक्त अवधि के लिए किया जा सकेगा। इस प्रमाण पत्र का उपयोग विधिक कार्यवाहियों अथवा विदेश में पंजीकरण प्राप्त करने के लिए नहीं हो सकता है।

*The reciprocity date (if any) which has been allowed and the name of the country. Copyright in the design will subsist for ten years from the date of Registration, and may under the terms of the Act and Rules, be extended for a further period of five years. This Certificate is not for use in legal proceedings or for obtaining registration abroad.



ORIGINAL

मूल/No : 130398



भारत सरकार
GOVERNMENT OF INDIA
पेटेंट कार्यालय
THE PATENT OFFICE

डिजाइन के पंजीकरण का प्रमाणपत्र
CERTIFICATE OF REGISTRATION OF DESIGN

डिजाइन सं. / Design No. : 368018-001
तारीख / Date : 20/07/2022
पारस्परिकता तारीख / Reciprocity Date* :
देश / Country :

प्रमाणित किया जाता है कि संलग्न प्रति में वर्णित डिजाइन जो **MOUTH GUARD FOR THE SCUBA DIVERS** से संबंधित है, का पंजीकरण, श्रेणी **24-01** में 1.Ms. Tejaswi Gadhiraju 2. Dr. Sagar Jalihal 3.Dr. Anil V Ankola 4.Dr. Ram Surath Kumar K 5.Ms. Aleena Tom 6.Dr. Atrey J Pai Khot के नाम में उपर्युक्त संख्या और तारीख में कर लिया गया है।

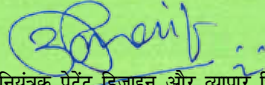
Certified that the design of which a copy is annexed hereto has been registered as of the number and date given above in class **24-01** in respect of the application of such design to **MOUTH GUARD FOR THE SCUBA DIVERS** in the name of 1.Ms. Tejaswi Gadhiraju 2. Dr. Sagar Jalihal 3.Dr. Anil V Ankola 4.Dr. Ram Surath Kumar K 5.Ms. Aleena Tom 6.Dr. Atrey J Pai Khot.

डिजाइन अधिनियम, 2000 तथा डिजाइन नियम, 2001 के अध्याधीन प्रावधानों के अनुसरण में।

In pursuance of and subject to the provisions of the Designs Act, 2000 and the Designs Rules, 2001.

INTELLECTUAL
PROPERTY INDIA
PATENTS | DESIGNS | TRADE MARKS
GEOGRAPHICAL INDICATIONS

निर्गमन की तारीख/Date of Issue : 09/03/2023


महानियंत्रक पेटेंट डिजाइन और व्यापार चिह्न
Controller General of Patents, Designs and Trade Marks

पारस्परिकता तारीख (यदि कोई हो) जिसकी अनुमति देश के नाम पर की गई है। डिजाइन का सत्त्वाधिकार पंजीकरण की तारीख से दस वर्षों के लिए होगा जिसका विस्तार, अधिनियम एवं नियम के निबंधनों के अधीन, पाँच वर्षों की अतिरिक्त अवधि के लिए किया जा सकेगा। इस प्रमाण पत्र का उपयोग विधिक कार्यवाहियों अथवा विदेश में पंजीकरण प्राप्त करने के लिए नहीं हो सकता है।

*The reciprocity date (if any) which has been allowed and the name of the country. Copyright in the design will subsist for ten years from the date of Registration, and may under the terms of the Act and Rules, be extended for a further period of five years. This Certificate is not for use in legal proceedings or for obtaining registration abroad.



ORIGINAL

मूल/No : 130323



भारत सरकार
GOVERNMENT OF INDIA
पेटेंट कार्यालय
THE PATENT OFFICE

डिजाइन के पंजीकरण का प्रमाणपत्र
CERTIFICATE OF REGISTRATION OF DESIGN

डिजाइन सं. / Design No. : 374389-001
तारीख / Date : 18/11/2022
पारस्परिकता तारीख / Reciprocity Date* :
देश / Country :

प्रमाणित किया जाता है कि संलग्न प्रति में वर्णित डिजाइन जो **TONGUE RETRACTOR WITH INCORPORATED SUCTION** से संबंधित है, का पंजीकरण, श्रेणी **24-01** में **1.Dr. Anabelle Louise Veiga Coutinho Fernandes 2. Dr. Arvind Shetti 3.Dr. Ansari Sulem Riyaz Ahmed 4.Dr. Jayraj B. Malik 5.Dr. Sridhar M 6.Dr. Lokesh Kumar S 7.Dr. Jayapriya T 8.Dr. Atrey Jagdish Pai Khot 9.Dr. Vaishali Keluskar 10.Dr. Tanvi Shukla 11.Dr. Namit Batra** के नाम में उपर्युक्त संख्या और तारीख में कर लिया गया है।

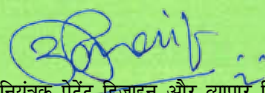
Certified that the design of which a copy is annexed hereto has been registered as of the number and date given above in class **24-01** in respect of the application of such design to **TONGUE RETRACTOR WITH INCORPORATED SUCTION** in the name of **1.Dr. Anabelle Louise Veiga Coutinho Fernandes 2. Dr. Arvind Shetti 3.Dr. Ansari Sulem Riyaz Ahmed 4.Dr. Jayraj B. Malik 5.Dr. Sridhar M 6.Dr. Lokesh Kumar S 7.Dr. Jayapriya T 8.Dr. Atrey Jagdish Pai Khot 9.Dr. Vaishali Keluskar 10.Dr. Tanvi Shukla 11.Dr. Namit Batra**.

डिजाइन अधिनियम, 2000 तथा डिजाइन नियम, 2001 के अध्याधीन प्रावधानों के अनुसरण में।

In pursuance of and subject to the provisions of the Designs Act, 2000 and the Designs Rules, 2001.

INTELLECTUAL
PROPERTY INDIA
PATENTS | DESIGNS | TRADE MARKS
GEOGRAPHICAL INDICATIONS

निर्गमन की तारीख/Date of Issue : 07/03/2023


महानियंत्रक पेटेंट डिजाइन और व्यापार चिह्न
Controller General of Patents, Designs and Trade Marks

पारस्परिकता तारीख (यदि कोई हो) जिसकी अनुमति देश के नाम पर की गई है। डिजाइन का सत्त्वाधिकार पंजीकरण की तारीख से दस वर्षों के लिए होगा जिसका विस्तार, अधिनियम एवं नियम के निबंधनों के अधीन, पाँच वर्षों की अतिरिक्त अवधि के लिए किया जा सकेगा। इस प्रमाण पत्र का उपयोग विधिक कार्यवाहियों अथवा विदेश में पंजीकरण प्राप्त करने के लिए नहीं हो सकता है।

*The reciprocity date (if any) which has been allowed and the name of the country. Copyright in the design will subsist for ten years from the date of Registration, and may under the terms of the Act and Rules, be extended for a further period of five years. This Certificate is not for use in legal proceedings or for obtaining registration abroad.



पेटेंट कार्यालय, भारत सरकार **The Patent Office, Government Of India**
पेटेंट प्रमाण पत्र **Patent Certificate**

(पेटेंट नियमावली का नियम 74) (Rule 74 of The Patents Rules)

पेटेंट सं. / Patent No. 460021

आवेदन सं. / Application No. 202041000037

फाइल करने की तारीख / Date of Filing 01/01/2020

पेटेंटी / Patentee 1. Dr. TEJASHRI PRADHAN 2. Dr VIJAY JAYADE

प्रमाणित किया जाता है कि पेटेंटी को, उपरोक्त आवेदन में यथाप्रकटित **BRAIDED STAINLESS STEEL TORQUING AUXILIARY AS A SUBSTITUTE TO FOUR SPUR TORQUING AUXILIARY IN BEGG TREATMENT**

नामक आविष्कार के लिए, पेटेंट अधिनियम, 1970 के उपबंधों के अनुसार आज तारीख जनवरी 2020 के पहले दिन से बीस वर्ष की अवधि के लिए पेटेंट अनुदत्त किया गया है।

It is hereby certified that a patent has been granted to the patentee for an invention entitled **BRAIDED STAINLESS STEEL TORQUING AUXILIARY AS A SUBSTITUTE TO FOUR SPUR TORQUING AUXILIARY IN BEGG TREATMENT** as disclosed in the above mentioned application for the term of 20 years

from the 1st day of January 2020 in accordance with the provisions of the Patents Act,1970.



[Signature]
पेटेंट नियंत्रक
Controller of Patents

अनुदान की तारीख / Date of Grant : 17/10/2023

टिप्पणी - इस पेटेंट के नवीकरण के लिए फीस, यदि इसे बनाए रखा जाना है, जनवरी 2022 के पहले दिन को और उसके पश्चात प्रत्येक वर्ष में उसी दिन देय होगी।
Note - The fees for renewal of this patent, if it is to be maintained, will fall / has fallen due on 1st day of January 2022 and on the same day in every year thereafter.

14. यदि कार्य एक 'कलात्मक कार्य' है जो किसी भी सामान या सेवाओं के संबंध में उपयोग किया जाता है या उपयोग करने में सक्षम है, तो आवेदन में कॉपीराइट अधिनियम, 1957 की धारा 45 की उप-धारा (प) के प्रावधान के अनुसार व्यापार चिह्न पंजीयक से प्रमाणन शामिल होना चाहिए।
If the work is an 'Artistic work' which is used or capable of being used in relation to any goods or services, the application should include a certification from the Registrar of Trade Marks in terms of the provision to Sub-Section (i) of Section 45 of the Copyright Act, 1957. : N.A.
15. यदि कार्य एक 'कलात्मक कार्य' है, तो क्या यह डिजाइन अधिनियम 2000 के अंतर्गत पंजीकृत है? यदि हां, तो विवरण दें
If the work is an 'Artistic work', whether it is registered under the Designs Act 2000 if yes give details. : N.A.
16. यदि कार्य एक 'कलात्मक कार्य' है, जो डिजाइन अधिनियम 2000 के तहत एक डिजाइन के रूप में पंजीकृत होने में सक्षम है, तो क्या यह औद्योगिक प्रक्रिया के माध्यम से किसी वस्तु पर प्रयोग में लाया गया है और यदि हां, तो इसे कितनी बार पुनः प्रस्तुत किया गया है?
If the work is an 'Artistic work', capable of being registered as a design under the Designs Act 2000, whether it has been applied to an article through an industrial process and ,if yes ,the number of times it is reproduced. : N.A.
17. टिप्पणी, यदि कोई हो/Remarks, if any :
- डायरी संख्या/Diary Number: 22482/2022-CO/L
- आवेदन की तिथि/Date of Application: 31/10/2022
- प्राप्ति की तिथि/Date of Receipt: 31/10/2022




Registrar of Copyrights

S. No.	Diary No.	RoC No.	Date	Title of Work	Category	Applicant
4843	22364/2022-CO/L	L-131052/2023	27-07-2023	Involute of Rhombus	Literary/ Dramatic	SAGE UNIVERSITY
4844	22107/2022-CO/L	L-131049/2023	27-07-2023	Analysis of the Aggregate Strength Variation Along Different Sections of the River Basin	Literary/ Dramatic	SRINIVAS UNIVERSITY
4845	22482/2022-CO/L	L-131054/2023	27-07-2023	Visual Performance Reinforcement Technique An Innovative Oral Health Educational Approach For Hearing and Speech Impaired Children	Literary/ Dramatic	DR APURVA PRASHANT DESHPANDE ,DR RAM SURATH KUMAR K
4846	20134/2022-CO/A	A-147098/2023	27-07-2023	MISS GOLD	Artistic	NISHA GAVERY
4847	19653/2022-CO/A	A-147075/2023	27-07-2023	SWAMI NARAYAN GURUJI (SCULPTURE)	Artistic	MR.BANDESH BHIKAJI GANJALE ,MRS.SUPRIYA SHEKHAR SHINDE
4848	24123/2022-CO/L	L-130966/2023	27-07-2023	Implementation of Hybridised Algorithm for Early Diagnosis of Skin Cancer	Literary/ Dramatic	DESH BHAGAT UNIVERSITY
4849	15284/2022-CO/L	L-130959/2023	27-07-2023	POSSIBILITIES OF ADAPTING NANOTECHNOLOGY BASED INNOVATIONS LEAVING CONVENTIONAL FARMING BY FARMERS	Literary/ Dramatic	CHETTINAD ACADEMY OF RESEARCH AND EDUCATION
4850	15051/2022-CO/L	L-130954/2023	27-07-2023	Time intensive Ibuprofen gel phonophoresis (IGP) protocol for osteoarthritis of knee joint: A roadmap to healthy lifestyle.	Literary/ Dramatic	DEEKSHA SHARMA
4851	15121/2022-CO/L	L-130944/2023	27-07-2023	An overview of the function of insulin in the management of blood glucose level.	Literary/ Dramatic	MONIKA KAUSHIK
4852	15085/2022-CO/L	L-130942/2023	27-07-2023	Let a Child to be a child-Road to Early puberty	Literary/ Dramatic	K VANITHA
4853	15044/2022-CO/L	L-130953/2023	27-07-2023	Comparative Innovation led sampling strategy for a randomized controlled design to evaluate high intensity laser therapy (Class-IV) and NSAIDs for treating knee osteoarthritis	Literary/ Dramatic	DEEKSHA SHARMA
4854	15092/2022-CO/L	L-130943/2023	27-07-2023	Effect of Dashansanskar mouthwash on periodontal parameters.	Literary/ Dramatic	DR SUREKHA RATHOD ,HARSH DEEPAKKUMAR BORUNDIA

(12) PATENT APPLICATION PUBLICATION

(21) Application No.202341008371 A

(19) INDIA

(22) Date of filing of Application :09/02/2023

(43) Publication Date : 17/02/2023

(54) Title of the invention : **HERBAL DENTAL GEL FORMULATION OF ZINGIBER OFFICINALE, SALVADORA PERSICA AND CINNAMOMUM ZEYLANICUM**

(51) International classification :A61K0036540000, A61K0036906800, A61Q0011000000, A61K0009000000, A61K0036185000

(86) International Application No :NA
Filing Date :NA

(87) International Publication No : NA

(61) Patent of Addition to Application Number :NA
Filing Date :NA

(62) Divisional to Application Number :NA
Filing Date :NA

(71)Name of Applicant :

1)DR. NEHA KOHLI

Address of Applicant :DEPARTMENT OF PEDIATRIC AND PREVENTIVE DENTISTRY, KLE V.K. INSTITUTE OF DENTAL SCIENCES, KLE UNIVERSITY, NEHRU NAGAR, JNMC CAMPUS, BELAGAVI, KARNATAKA, INDIA 590010.

2)DR. SHIVAYOGI M. HUGAR

3)DR. KRISHNA KADAM

4)DR. BHASKAR KURANGI

5)DR. VIDYAVATHI H. PATIL

6)DR. SHWETA HUGAR

7)DR. SANJANA SONETA

8)DR. NIVEDITA SAXENA

9)DR. CHAITANYA UPPIN

Name of Applicant : NA

Address of Applicant : NA

(72)Name of Inventor :

1)DR. NEHA KOHLI

Address of Applicant :DEPARTMENT OF PEDIATRIC AND PREVENTIVE DENTISTRY, KLE V.K. INSTITUTE OF DENTAL SCIENCES, KLE UNIVERSITY, NEHRU NAGAR, JNMC CAMPUS, BELAGAVI, KARNATAKA, INDIA 590010.

2)DR. SHIVAYOGI M. HUGAR

Address of Applicant :DEPARTMENT OF PEDIATRIC AND PREVENTIVE DENTISTRY, KLE V.K. INSTITUTE OF DENTAL

SCIENCE, KLE UNIVERSITY, NEHRU NAGAR, JNMC CAMPUS, BELAGAVI, KARNATAKA, INDIA 590010. -----
DR. KRISHNA KADAM
Address of Applicant :DEPARTMENT OF PEDIATRIC AND PREVENTIVE DENTISTRY, KLE V.K. INSTITUTE OF DENTAL SCIENCES, KLE UNIVERSITY, NEHRU NAGAR, JNMC CAMPUS, BELAGAVI, KARNATAKA, INDIA 590010. -----
DR. BHASKAR KURANGI
Address of Applicant :DEPARTMENT OF PEDIATRIC AND PREVENTIVE DENTISTRY, KLE V.K. INSTITUTE OF DENTAL SCIENCES, KLE UNIVERSITY, NEHRU NAGAR, JNMC CAMPUS, BELAGAVI, KARNATAKA, INDIA 590010. -----
DR. VIDYAVATHI H. PATIL
Address of Applicant :DEPARTMENT OF PEDIATRIC AND PREVENTIVE DENTISTRY, KLE V.K. INSTITUTE OF DENTAL SCIENCES, KLE UNIVERSITY, NEHRU NAGAR, JNMC CAMPUS, BELAGAVI, KARNATAKA, INDIA 590010. -----
DR. SHWETA HUGAR
Address of Applicant :DEPARTMENT OF PEDIATRIC AND PREVENTIVE DENTISTRY, KLE V.K. INSTITUTE OF DENTAL SCIENCES, KLE UNIVERSITY, NEHRU NAGAR, JNMC CAMPUS, BELAGAVI, KARNATAKA, INDIA 590010. -----

7)DR. SANJANA SONETA

Address of Applicant :DEPARTMENT OF PEDIATRIC AND PREVENTIVE DENTISTRY, KLE V.K. INSTITUTE OF DENTAL SCIENCES, KLE UNIVERSITY, NEHRU NAGAR, JNMC CAMPUS, BELAGAVI, KARNATAKA, INDIA 590010. -----
DR. NIVEDITA SAXENA
Address of Applicant :DEPARTMENT OF PEDIATRIC AND PREVENTIVE DENTISTRY, KLE V.K. INSTITUTE OF DENTAL SCIENCES, KLE UNIVERSITY, NEHRU NAGAR, JNMC CAMPUS, BELAGAVI, KARNATAKA, INDIA 590010. -----
DR. CHAITANYA UPPIN
Address of Applicant :DEPARTMENT OF PEDIATRIC AND PREVENTIVE DENTISTRY, KLE V.K. INSTITUTE OF DENTAL SCIENCES, KLE UNIVERSITY, NEHRU NAGAR, JNMC CAMPUS, BELAGAVI, KARNATAKA, INDIA 590010. -----

(57) Abstract :

Abstract: The present invention relates to the development of Herbal Dental gel formulation with ethanolic extracts of Zingiber Officinale, Salvador a Persica and Cinnamomum Zeylanicum for dental applications. It specifically relates to the development of Herbal Dental gel formulation with ethanolic extracts of Zingiber Officinale, Salvador a Persica and Cinnamomum Zeylanicum against Streptococcus mutans and Lactobacillus acidophilus. The invention also pertains to the development of process for preparation of Herbal Dental gel formulation with remineralization potential. Herbal Dental gel formulation of Zingiber Officinale, Salvador a Persica and Cinnamomum Zeylanicum for dental applications comprising the effective concentration of ethanolic extract of Zingiber Officinale, Salvador a Persica and Cinnamomum Zeylanicum as 2% w/w complexed with other excipients.

No. of Pages : 30 No. of Claims : 10

(12) PATENT APPLICATION PUBLICATION

(21) Application No.202341008370 A

(19) INDIA

(22) Date of filing of Application :09/02/2023

(43) Publication Date : 17/02/2023

(54) Title of the invention : HERBAL MOUTHWASH FORMULATIONS OF MOMORDICA CHARANTIA EXTRACT AND SPINACIA OLERACEA EXTRACT

(51) International classification :A61K0036420000, A61Q0011000000, A61K0008978900, A61K0036610000, A23L0033105000

(86) International Application No :NA
Filing Date :NA

(87) International Publication No : NA

(61) Patent of Addition to Application Number :NA
Filing Date :NA

(62) Divisional to Application Number :NA
Filing Date :NA

(71)Name of Applicant :

1)DR. KRISHNA KADAM

Address of Applicant :DEPARTMENT OF PEDIATRIC AND PREVENTIVE DENTISTRY, KLE V.K. INSTITUTE OF DENTAL SCIENCES, KLE UNIVERSITY, NEHRU NAGAR, INMC CAMPUS, BELAGAVI, KARNATAKA, INDIA 590010

2)DR. NIRAJ GOKHALE

3)DR. SHIVAYOGI M. HUGAR

4)DR. NEHA KOHLI

5)DR. SHWETA KAJJARI

6)DR. BHASKAR KURANGI

7)DR. CHANDRASHEKHAR BADAOKAR

8)DR. SHWETA S. HUGAR

Name of Applicant : NA

Address of Applicant : NA

(72)Name of Inventor :

1)DR. KRISHNA KADAM

Address of Applicant :DEPARTMENT OF PEDIATRIC AND PREVENTIVE DENTISTRY, KLE V.K. INSTITUTE OF DENTAL SCIENCES, KLE UNIVERSITY, NEHRU NAGAR, INMC CAMPUS, BELAGAVI, KARNATAKA, INDIA 590010

2)DR. NIRAJ GOKHALE

Address of Applicant :DEPARTMENT OF PEDIATRIC AND PREVENTIVE DENTISTRY, KLE V.K. INSTITUTE OF DENTAL SCIENCES, KLE UNIVERSITY, NEHRU NAGAR, INMC CAMPUS, BELAGAVI, KARNATAKA, INDIA 590010

3)DR. SHIVAYOGI M. HUGAR

Address of Applicant :DEPARTMENT OF PEDIATRIC AND PREVENTIVE DENTISTRY, KLE V.K. INSTITUTE OF DENTAL SCIENCES, KLE UNIVERSITY, NEHRU NAGAR, INMC CAMPUS, BELAGAVI, KARNATAKA, INDIA 590010

4)DR. NEHA KOHLI

Address of Applicant :DEPARTMENT OF PEDIATRIC AND PREVENTIVE DENTISTRY, KLE V.K. INSTITUTE OF DENTAL SCIENCES, KLE UNIVERSITY, NEHRU NAGAR, INMC CAMPUS, BELAGAVI, KARNATAKA, INDIA 590010

5)DR. SHWETA KAJJARI

Address of Applicant :DEPARTMENT OF PEDIATRIC AND PREVENTIVE DENTISTRY, KLE V.K. INSTITUTE OF DENTAL SCIENCES, KLE UNIVERSITY, NEHRU NAGAR, INMC CAMPUS, BELAGAVI, KARNATAKA, INDIA 590010

6)DR. BHASKAR KURANGI

Address of Applicant :DEPARTMENT OF PHARMACEUTICALS, COLLEGE OF PHARMACY KAHER, NEHRU NAGAR, BELAGAVI, KARNATAKA, INDIA 590010

7)DR. CHANDRASHEKHAR BADAOKAR

Address of Applicant :DEPARTMENT OF PEDIATRIC AND PREVENTIVE DENTISTRY, KLE V.K. INSTITUTE OF DENTAL SCIENCES, KLE UNIVERSITY, NEHRU NAGAR, INMC CAMPUS, BELAGAVI, KARNATAKA, INDIA 590010

8)DR. SHWETA S. HUGAR

Address of Applicant :DEPARTMENT OF PERIODONTICS, KLE V.K. INSTITUTE OF DENTAL SCIENCES, KLE UNIVERSITY, NEHRU NAGAR, INMC CAMPUS, BELAGAVI, KARNATAKA, INDIA 590010

(57) Abstract :

Abstract: The present invention relates to the development of herbal mouthwashes with extracts of Momordica charantia and Spinacia oleracea against the Streptococcus mutans, Lactobacillus acidophilus and Porphyromonas gingivalis for prevention of dental caries and gingivitis. Process for preparation of Mouthwash formulation of Momordica charantia and Spinacia oleracea for dental applications comprising: a) preparation of ethanolic extract of Momordica charantia and Spinacia oleracea b) Distilled water Mixed with preservatives as solution 1 c) Separate addition of distilled water containing artificial sweetening agents as solution 2 (d) Addition of ethanolic extract based on Minimum Inhibitory Concentration and Minimum Bacterial Concentration with solution 1 and solution 2 to form the uniform mouthwash formulation of Momordica charantia and Spinacia oleracea separately.

No. of Pages : 30 No. of Claims : 10

(54) Title of the invention : **THE METHOD OF SYNTHESIZING A MUCOADHESIVE GEL FOR ORAL LEUKOPLAKIA USING MORINGA OLEIFERA EXTRACT.**

(51) International classification :A61K0009000000, A61K0036185000, A61K0047320000, A61Q0019000000, A61K0047360000

(86) International Application No :NA
 Filing Date :NA

(87) International Publication No : NA

(61) Patent of Addition to Application Number :NA
 Filing Date :NA

(62) Divisional to Application Number :NA
 Filing Date :NA

(71)Name of Applicant :
1)Dr. Ansari Sulem Riyaz Ahmed
 Address of Applicant :Room No :20 Bldg No:21, Parksite Municipal Colony, Vikhroli West, Near Vikhroli Bus Depot, Mumbai- 400079 -----
2)Dr. Shivayogi Charantimath
3)Dr. Anabelle Louise Veiga Coutinho Fernandes
4)Dr. Jayraj B. Malik
5)Dr. Lokesh Kumar S
6)Dr. Arun Panwar
7)Dr. Ram Surath Kumar K
8)Dr. Atrey J. Pai Khot
 Name of Applicant : NA
 Address of Applicant : NA

(72)Name of Inventor :
1)Dr. Ansari Sulem Riyaz Ahmed
 Address of Applicant :Room No :20 Bldg No:21, Parksite Municipal Colony, Vikhroli West, Near Vikhroli Bus Depot, Mumbai- 400079 -----
2)Dr. Shivayogi Charantimath
 Address of Applicant :Department Of Oral Medicine And Radiology , Kle Vk Institute Of Dental Sciences, Jnmc Campus, Belagavi – 590010 -----
3)Dr. Anabelle Louise Veiga Coutinho Fernandes
 Address of Applicant :House No.167 Near Carmelite Monastery, Rua Martires Dias, Aquem,Margao-Goa 403601 -----
4)Dr. Jayraj B. Malik
 Address of Applicant :H.No. 513 Satiche Bhat, Cudnem Sankhalim Goa 403505 -----
5)Dr. Lokesh Kumar S
 Address of Applicant :No. 13/7, Venkatachalapathy Street, Rajakilpakkam, Chennai- 600073 --
6)Dr. Arun Panwar
 Address of Applicant :146/1, Shahpur Jat, New Delhi 110049 -----
7)Dr. Ram Surath Kumar K
 Address of Applicant :207/18/1, Ananthu Illam, Brindhavan Avenue, Chinnakanmai Street, Cm Road, Madurai – 625009, Tamil Nadu, India -----
8)Dr. Atrey J. Pai Khot
 Address of Applicant :H. No:230, Khotawada, Sadolxem, Poinguinim, Canacona, Goa 403702 -----

(57) Abstract :
 This invention describes a method of formulating a mucoadhesive gel for oral leukoplakia using Moringa Oleifera extract. The composition consists of Carbopol 940, Distilled water, M. oleifera leaves extract, TEA(Triethanolamine), Methylparaben and Ethyl paraben. The preparation is done in a sterile condition where Flavonoids were extracted from M. oleifera leaves and Carbopol 940 was used as a gelling agent. Futher TEA was used to enhance the gelling property and Methyl and ethyl paraben were used as a preservatives The prepared gel showed antibacterial capabilities and Moringa oleifera mucoadhesive gel reduced the size of the lesion in oral leukoplakia patients. The method of synthesizing a mucoadhesive gel for oral leukoplakia using Moringa Oleifera extract.

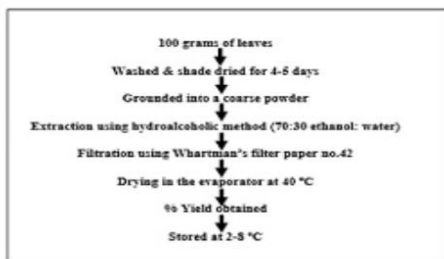


Figure - 1 : Shows the Flow chart of the process of Extracting the extract from Moringa Oleifera leaves.

No. of Pages : 17 No. of Claims : 1

(54) Title of the invention : **CHLORHEXIDINE DIACETATE COATED BLACK BRAIDED SILK i.e. CDC-BBS SUTURES FOR CLOSURE OF SURGICAL WOUNDS IN THE ORAL CAVITY.**

<p>(51) International classification :A01N 474400, A61K 084300, A61K 086400, A61K 311550, A61Q 110000</p> <p>(86) International Application No :PCT//</p> <p>Filing Date :01/01/1900</p> <p>(87) International Publication No : NA</p> <p>(61) Patent of Addition to Application Number :NA</p> <p>Filing Date :NA</p> <p>(62) Divisional to Application Number :NA</p> <p>Filing Date :NA</p>	<p>(71)Name of Applicant :</p> <p>1)Sachin Kheatni Address of Applicant :Department of Oral and Maxillofacial Surgery,KLE V.K. Institute Of Dental Science, KLE Academy Of Higher Education And Research, Nehrunagar, JNMC Campus, Belagavi - 590010, Karnataka, INDIA -----</p> <p>2)Dr. Sanjay S. Rao</p> <p>3)Dr. Punnya Angadi</p> <p>4)Dr. Deepa R. Mane</p> <p>Name of Applicant : NA Address of Applicant : NA</p> <p>(72)Name of Inventor :</p> <p>1)Sachin Kheatni Address of Applicant :Department of Oral and Maxillofacial Surgery,KLE V.K. Institute Of Dental Science, KLE Academy Of Higher Education And Research, Nehru Nagar, JNMC Campus, Belagavi - 590010, Karnataka, INDIA -----</p> <p>2)Dr. Sanjay S. Rao Address of Applicant :Department of Oral and Maxillofacial Surgery, KLE V.K. Institute of Dental Sciences, KLE Academy of Higher Education and Research, Nehru Nagar, JNMC Campus, Belagavi – 590010, Karnataka, INDIA Belagavi -----</p> <p>3)Dr. Punnya Angadi Address of Applicant :DEPARTMENT OF ORAL AND MAXILLOFACIAL PATHOLOGY, KLE VK INSTITUTE OF DENTAL SCIENCES, KAHER,NEHRU NAGAR, BELAGAVI Belagavi -----</p> <p>4)Dr. Deepa R. Mane Address of Applicant :DEPARTMENT OF ORAL AND MAXILLOFACIAL PATHOLOGY, KLE VK INSTITUTE OF DENTAL SCIENCES, KAHER,NEHRU NAGAR, BELAGAVI Belagavi -----</p>
--	---

(57) Abstract :

The present technique involves development of novel anti-microbial suture named the CDC-BBS suture containing chlorhexidine-diacetate coating over the black braided silk suture for closure of surgical wounds of the oral cavity. This could be considered as a promising alternative to the conventional black braided silk suture employed for wound closure of surgical margins in the oral cavity and prevents surgical site infection. Chlorhexidine-diacetate coated black braided silk sutures demonstrated enhanced anti-microbial efficacy in comparison with conventional plain black braided silk suture. It showed no cytotoxicity and exhibited enhanced fibroblast proliferation which promotes wound healing. Using chlorhexidine-coated sutures, can help prevent bacterial growth and reduce the risk of infection at the surgical site. Furthermore, the use of chlorhexidine-coated sutures may also reduce the need for antibiotics in some cases. This can be particularly beneficial for patients who are at higher risk of developing complications from antibiotic use, such as those with a history of allergic reactions or who are immunocompromised. The use of chlorhexidine diacetate coated silk suture delivers antibacterial effect through local drug delivery system, will decrease the use of systemic antibiotic load and preventing development of antibiotic resistance. This positive effect can potentially result in improved patient outcomes as well as diminished necessity for supplementary medical intervention.

No. of Pages : 39 No. of Claims : 11

ANNEXURE I

(12) PATENT APPLICATION PUBLICATION

(21) Application No.202341030001 A

(19) INDIA

(22) Date of filing of Application :26/04/2023

(43) Publication Date : 26/05/2023

(54) Title of the invention : **DEVELOPMENT OF HERBAL ANTIFUNGAL GEL CONTAINING ORIGANUM VULGARE AND SYZYGIUM AROMATICUM ESSENTIAL OIL AGAINST ORAL CANDIDA ALBICANS**

(51) International classification :A01N 650000, A61K 365300, A61K 366100, A61P 311000, C07K 144000
 (86) International Application No :PCT//
 Filing Date :01/01/1900
 (87) International Publication No : NA
 (61) Patent of Addition to Application Number :NA
 Filing Date :NA
 (62) Divisional to Application Number :NA
 Filing Date :NA

(71)Name of Applicant :

1)Pavithra J

Address of Applicant :DEPARTMENT OF ORAL PATHOLOGY AND MICROBIOLOGY, KLE VK INSTITUTE OF DENTAL SCIENCES, KAHER, NEHRU NAGAR, BELAGAVI -----

2)Dr. Manjula M

3)Dr. Bhaskar Kurangi

4)Dr. Rubina Mulla

5)Dr. Deepa R. Mane

Name of Applicant : NA

Address of Applicant : NA

(72)Name of Inventor :

1)Pavithra J

Address of Applicant :DEPARTMENT OF ORAL PATHOLOGY AND MICROBIOLOGY, KLE VK INSTITUTE OF DENTAL SCIENCES, KAHER, NEHRU NAGAR, BELAGAVI -----

2)Dr. Manjula M

Address of Applicant :KLE VK INSTITUTE OF DENTAL SCIENCES, KAHER, NEHRU NAGAR, BELAGAVI Belagavi --

3)Dr. Bhaskar Kurangi

Address of Applicant :KLE COLLEGE OF PHARMACY, JNMC CAMPUS, KAHER, NEHRU NAGAR, BELAGAVI Belagavi --

4)Dr. Rubina Mulla

Address of Applicant :DEPARTMENT OF MICROBIOLOGY, JNMC CAMPUS, KAHER, NEHRU NAGAR, BELAGAVI Belagavi -----

5)Dr. Deepa R. Mane

Address of Applicant :KLE VK INSTITUTE OF DENTAL SCIENCES, KAHER, NEHRU NAGAR, BELAGAVI Belagavi --

(57) Abstract :

The novel antifungal herbal gel containing Origanum vulgare and Syzygium aromaticum essential oil could be considered as a promising alternative therapeutic approach to treat Oral candidiasis. The present invention demonstrated enhanced antifungal efficacy in comparison with the standard antifungal drug.

No. of Pages : 30 No. of Claims : 5

(54) Title of the invention : **FORMULATION OF POLYHERBAL JELLY**

(51) International classification :A23L 211000, A47K 050800, A61K 361850, A61K 362200, C11D 131600
 (86) International Application No :NA
 Filing Date :NA
 (87) International Publication No :NA
 (61) Patent of Addition to Application Number :NA
 Filing Date :NA
 (62) Divisional to Application Number :NA
 Filing Date :NA

(71)Name of Applicant :
1)DR APURVA PRASHANT DESHPANDE
 Address of Applicant :VS IPR & LEGAL ADVISORS B-005/, SURYAKIRAN SOCIETY, AWADHUT NAGAR, NEAR RAHUL ELECTRONIC, DAHISAR EAST -----
2)DR APURVA PRASHANT DESHPANDE
 Name of Applicant : NA
 Address of Applicant : NA
 (72)Name of Inventor :
1)DR ANIL V ANKOLA
 Address of Applicant :Department Of Public Health Dentistry, V K Institute of Dental Sciences, KLE Academy of Higher Education and Research BELAGAVI -----
2)DR VEENA V. NAIK
 Address of Applicant :Department of Oral Pathology and Microbiology, V K Institute of Dental Sciences, KLE Academy of Higher Education and Research BELAGAVI -----
3)DR SHEFALI G PEDNECAR
 Address of Applicant :Flat 504, Kamat Galaxy Caranzalem, PANJIM -----
4)MR U B BOLMAL
 Address of Applicant :Department Of Pharmaceutics, Rani Chennamma College of Pharmacy BELGAUM -----
5)DR ROOPALI M SANKESHWARI
 Address of Applicant :Department Of Public Health Dentistry, V K Institute of Dental Sciences, KLE Academy of Higher Education and Research BELGAUM -----
6)DR SAGAR JALJHAL
 Address of Applicant :Department Of Public Health Dentistry, V K Institute of Dental Sciences, KLE Academy of Higher Education and Research BELGAUM -----
7)DR VINUTA HAMPIHOLI
 Address of Applicant :Department Of Public Health Dentistry, V K Institute of Dental Sciences, KLE Academy of Higher Education and Research BELGAUM -----
8)DR LAXMI KABRA
 Address of Applicant :Department Of Public Health Dentistry, V K Institute of Dental Sciences, KLE Academy of Higher Education and Research BELGAUM -----
9)MR ATHARVA PRASHANT DESHPANDE
 Address of Applicant :1468/82 ,Plot No 82, FAJ Housing Colony MADEL, THIVIM, -----
10)MR KESHAV DUKLE
 Address of Applicant :1283 Annavado, Candolim -----
11)DR VAIBHAV KUMAR
 Address of Applicant :SHREE KRISHNA GARDEN, 3RD FLOOR, 14/110 GOLF CLUB ROAD KOLKATA -----
12)DR RAM SURATH KUMAR
 Address of Applicant :Department Of Public Health Dentistry, V K Institute of Dental Sciences, KLE Academy of Higher Education and Research BELAGAVI -----
13)DR ATREY JAGDISH PAI KHOT
 Address of Applicant :Department Of Public Health Dentistry, V K Institute of Dental Sciences, KLE Academy of Higher Education and Research BELAGAVI -----
14)DR APURVA PRASHANT DESHPANDE
 Address of Applicant :Department Of Public Health Dentistry, V K Institute of Dental Sciences, KLE Academy of Higher Education and Research BELAGAVI -----

(57) Abstract :

Oral health is a key indicator of overall health and it has been rightly said that one is not healthy without good oral health. Oral health plays a vital role in the better and improved performance of individuals – World Health Organization (WHO). It is responsible in maintaining quality of life and general health. According to the World Health Organization (WHO) report, dental caries is one of the major public health problem affecting 60-90% of school going children and almost 100% of the adult population in the developing countries. There are various Oral health related issues which are of great concern for Indian population, despite having the highest number of dental schools worldwide. Dental caries is an infectious, microbiological, progressive disease causing localized dissolution of tooth surface. The first sign of tooth caries is manifested clinically by a milky white opacity. This incipient carious lesion is manifested by subsurface porosity which is being caused by an imbalance between the dynamic biological processes of de- and remineralisation. It is a multifactorial disease which is based on a four-factor theory that includes oral microorganisms, oral environment, host, and time. The human oral cavity is a complex ecosystem which is inhabited by more than 300 bacterial species, mycoplasmas, protozoa, and yeasts. Restricted-activity days, including missing school, than those who do not. Annually, more than 50 million hours are lost from school due to oral diseases.

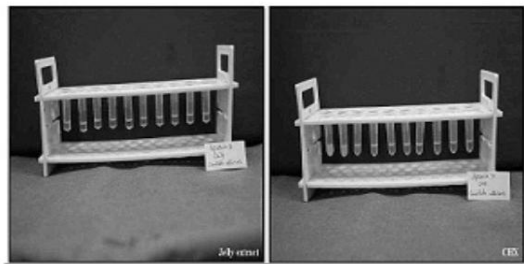


FIG. 1

No. of Pages : 23 No. of Claims : 13

(54) Title of the invention : **OCIMUM BASILICUM DENTAL VARNISH COMPOSITION, ITS METHOD OF PREPARATION AND ORAL USE THEREOF**



(51) International classification :A01N 65/22, A61K 31/202, A61K 36/53, A61K 8/97
 (86) International Application No :PCT//
 Filing Date :01/01/1900
 (87) International Publication No :NA
 (61) Patent of Addition to Application Number :NA
 Filing Date :NA
 (62) Divisional to Application Number :NA
 Filing Date :NA

(71)Name of Applicant :
1)Dr. Atrey Jagdish Pai Khot
 Address of Applicant :Department of Public Health Dentistry, KLE Vishwanath Katti Institute of Dental Sciences, KLE Academy of Higher Education and research, Nehru Nagar, Belagavi-590010, Karnataka, India Belagavi -----
2)Dr. Anil V. Ankola
3)Dr. Veena V. Naik
4)Dr. Roopali M. Sankeshwari
5)Dr. Ram Surath Kumar K
 Name of Applicant : NA
 Address of Applicant : NA
 (72)Name of Inventor :
1)Dr. Atrey Jagdish Pai Khot
 Address of Applicant :Department of Public Health Dentistry, KLE Vishwanath Katti Institute of Dental Sciences, KLE Academy of Higher Education and Research, Nehru Nagar, Belagavi-590010, Karnataka, India Belagavi -----
2)Dr. Anil V. Ankola
 Address of Applicant :Department of Public Health Dentistry, KLE Vishwanath Katti Institute of Dental Sciences, KLE Academy of Higher Education and Research, Nehru Nagar, Belagavi-590010, Karnataka, India Belagavi -----
3)Dr. Veena V. Naik
 Address of Applicant :Department of Oral and Maxillofacial Pathology and Oral Microbiology, KLE Vishwanath Katti Institute of Dental Sciences, KLE Academy of Higher Education and Research, Nehru Nagar, Belagavi- 590010, Karnataka, India Belagavi -----
4)Dr. Roopali M. Sankeshwari
 Address of Applicant :Department of Public Health Dentistry, KLE Vishwanath Katti Institute of Dental Sciences, KLE Academy of Higher Education and Research, Nehru Nagar, Belagavi-590010, Karnataka, India Belagavi -----
5)Dr. Vinuta Hampiholi
 Address of Applicant :Department of Periodontics, KLE Vishwanath Katti Institute of Dental Sciences, KLE Academy of Higher Education and Research, Nehru Nagar, Belagavi-590010, Karnataka, India Belagavi -----
6)Dr. Sagar Jalihal
 Address of Applicant :Department of Public Health Dentistry, KLE Vishwanath Katti Institute of Dental Sciences, KLE Academy of Higher Education and Research, Nehru Nagar, Belagavi-590010, Karnataka, India Belagavi -----
7)Dr. Shushant Iragonda Jigan
 Address of Applicant :Department of Microbiology, Jawaharlal Nehru Medical College, KLE Academy of Higher Education and Research, Belagavi-590010, Karnataka, India Belagavi -----
8)Dr. Ram Surath Kumar K
 Address of Applicant :Department of Public Health Dentistry, KLE Vishwanath Katti Institute of Dental Sciences, KLE Academy of Higher Education and Research, Nehru Nagar, Belagavi-590010, Karnataka, India Belagavi -----
9)Dr. Mehul A. Shah
 Address of Applicant :Department of Public Health Dentistry, KLE Vishwanath Katti Institute of Dental Sciences, KLE Academy of Higher Education and Research, Nehru Nagar, Belagavi-590010, Karnataka, India Belagavi -----
10)Dr. Anu Sara Varghese
 Address of Applicant :Department of Public Health Dentistry, KLE Vishwanath Katti Institute of Dental Sciences, KLE Academy of Higher Education and Research, Nehru Nagar, Belagavi-590010, Karnataka, India Belagavi -----
11)Dr. Siva Shankkari T
 Address of Applicant :Department of Public Health Dentistry, KLE Vishwanath Katti Institute of Dental Sciences, KLE Academy of Higher Education and Research, Nehru Nagar, Belagavi-590010, Karnataka, India Belagavi -----
12)Dr. Varkey N S
 Address of Applicant :Department of Public Health Dentistry, KLE Vishwanath Katti Institute of Dental Sciences, KLE Academy of Higher Education and Research, Nehru Nagar, Belagavi-590010, Karnataka, India Belagavi -----
13)Dr. Prajakta J. Chavan
 Address of Applicant :Department of Public Health Dentistry, KLE Vishwanath Katti Institute of Dental Sciences, KLE Academy of Higher Education and Research, Nehru Nagar, Belagavi-590010, Karnataka, India Belagavi -----
14)Dr. Jayraj Malik
 Address of Applicant :Department of Oral Medicine and Radiology, KLE Vishwanath Katti Institute of Dental Sciences, KLE Academy of Higher Education and Research, Nehru Nagar, Belagavi-590010, Karnataka, India Belagavi -----

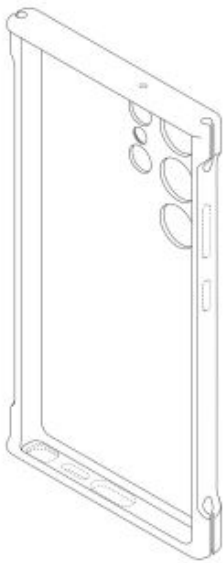
(57) Abstract :
 ABSTRACT OCIMUM BASILICUM DENTAL VARNISH COMPOSITION, ITS METHOD OF PREPARATION AND ORAL USE THEREOF The dosage form and remineralization potential of Ocimum basilicum has not been tested which can be used in public health programs. Hence, the present invention presents the details of Ocimum basilicum varnish, its preparation and its comparison with Fluoride varnish. The present invention relates to the development of varnish formulation with alcoholic extracts of Ocimum basilicum for initial enamel caries. It specifically relates to the development of dental varnish for remineralization potential. The invention also pertains to the development of process for the preparation of varnish formulation.

No. of Pages : 31 No. of Claims : 10


Design Number	396399-001	
Class	24-01	
1. Dr. Gowsalya M Department of Oral Pathology and Microbiology, KLE Vishwanath Katti Institute of Dental Sciences, KLE Academy of Higher Education and Research, Nehru Nagar, Belagavi-590010, Karnataka, India 2. Dr. S Rao Department of Oral Pathology and Microbiology, KLE Vishwanath Katti Institute of Dental Sciences, KLE Academy of Higher Education and Research, Nehru Nagar, Belagavi-590010, Karnataka, India 3. Mr. Ramesh Kurbet School of mechanical engineering, KLE technological University, Hubballi 4. Dr. Seema Halikerimath Department of Oral Pathology and Microbiology, KLE Vishwanath Katti Institute of Dental Sciences, KLE Academy of Higher Education and Research, Nehru Nagar, Belagavi-590010, Karnataka, India		
Date of Registration	30/09/2023	
Title	PORTABLE DENTAL UV STERILIZER	
Priority NA		
Design Number	396285-001	
Class	14-02	
Prof. (Dr.) Abhishek Roy Professor, Department of Computer Science and Engineering, Adamas University, Barasat – Barrackpore Road, P.O. – Jagannathpur, District-24 Parganas (North), Kolkata-700126, West Bengal, India.		
Date of Registration	28/09/2023	
Title	BIOMETRIC BASED SERVICE GUIDANCE DEVICE	
Priority NA		
Design Number	339931-001	
Class	02-02	
MR. SUKUMAR MUKHERJEE and MR. SABYASACHI MUKHERJEE Trading as SABYASACHI CALCUTTA LLP 80/2, Topsia Road South, Kolkata-700046, West Bengal.		
Date of Registration	01/03/2021	
Title	LADIES GARMENT (SET)	
Priority NA		

Design Number	380841-001	
Class	24-02	
Indian Institute of Technology Kanpur Dean, Research & Development, Room Number 151, Faculty Building, Post Office: IIT Kanpur, Kanpur-208016, U.P, India		
Date of Registration	06/03/2023	
Title	Glass Ampoule Breaker	
Priority NA		
Design Number	396356-001	
Class	24-04	
1. Dr. Bindurani L G P Ram Associate Professor, Dnyanvilas College of Pharmacy, Dudhgaon, Pimpri-Chinchwad Corporation Area, Moshi - Alandi Road, Pimpri-Chinchwad, Maharashtra - 412105 2. Dr. Smita Sanjay Waghmare Assistant Professor, Dnyanvilas College of Pharmacy, Dudhgaon, Pimpri-Chinchwad Corporation Area.		
Date of Registration		
Title		
Priority NA		


Design Number	379019-001	
Class	03-01	
SAMSUNG ELECTRONICS CO., LTD. 129, Samsung-ro, Yeongtong-gu, Suwon-si, Gyeonggi-do, Republic of Korea		
Date of Registration	09/02/2023	
Title	CASE FOR MOBILE PHONE	
Priority		
Priority Number	Date	Country
30-2022-0032788	12/08/2022	Republic of Korea



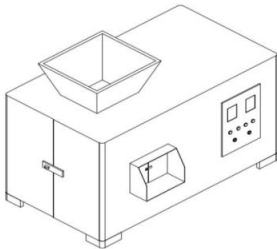



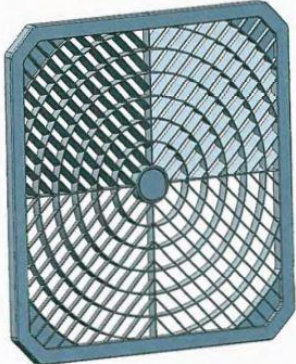

Design Number	378989-001	
Class	24-01	
Rajesh Suhas Swami Department of Prosthodontics, KLE VK Institute of Dental Sciences and Hospital, J.N. Medical College Campus, Nehru nagar, Belagavi-590010		
Date of Registration	09/02/2023	
Title	METRIC DENTAL HOT PLATE	
Priority NA		



Design Number	378062-001	
Class	13-01	
1.Sri Manakula Vinayagar Engineering College Madagadipet, Puducherry - 605 107, India 2. Dr. V.S.K. Venkatachalapathy Director Cum Principal, Sri Manakula Vinayagar Engineering College, Madagadipet, Puducherry - 605 107, India 3. Dr. K. Velmurugan Head & Dean Research, Department of Mechanical Engineering, Sri Manakula Vinayagar Engineering College, Madagadipet, Puducherry - 605 107, India 4. A. Dhanushkumar Department of Mechanical Engineering, Sri Manakula Vinayagar Engineering College, Madagadipet, Puducherry - 605 107, India , et al.		
Date of Registration	27/01/2023	
Title	ENERGY GENERATING EQUIPMENT USING DUAL FLYWHEEL	
Priority NA		



Design Number	378218-015	
Class	02-02	
Reflect Sculpt Pvt. Ltd. A-42, Sector - 5, Noida, U.P. 201301, India		
Date of Registration	30/01/2023	
Title	GARMENT	
Priority NA		
Design Number	378990-001	
Class	24-02	
Rajesh Suhas Swami Department of Prosthodontics, KLE VK Institute of Dental Sciences and Hospital, J.N. Medical College Campus, Nehru nagar, Belagavi-590010		
Date of Registration	09/02/2023	
Title	METRIC DENTAL WAX KNIFE	
Priority NA		
Design Number	380128-001	
Class	23-99	
1.Andhra University Visakhapatnam, Andhra Pradesh, India. Pin Code: 530003. 2. Prof. James Stephen Meka Dr. B. R. Ambedkar Chair Professor, Dean, A.U. TDR-HUB, Andhra University, Visakhapatnam, Andhra Pradesh, India. Pin Code: 530003. 3. Mr. K Joseph Noel Associate Professor, Department of Mechanical Engineering, Welfare Institute of Science Technology and Management, Pinagadi Village, Pendurthy Mandal, Visakhapatnam, Andhra Pradesh, India. Pin Code:531173. 4. Dr.Ch.Praveen Babu Associate Professor, Department of ECE, Welfare Institute of Science Technology and Management, Pinagadi Village, Pendurthy Mandal, Visakhapatnam, Andhra Pradesh, India. Pin Code:531173. , et al.		
Date of Registration	25/02/2023	
Title	Smart Plastic Waste Management Machine	
Priority NA		

Design Number	378991-001	
Class	24-01	
Rajesh Suhas Swami Department of Prosthodontics, KLE VK Institute of Dental Sciences and Hospital, J.N. Medical College Campus, Nehru nagar, Belagavi-590010		
Date of Registration	09/02/2023	
Title	DENTAL WAX SPOON	
Priority NA		
Design Number	377364-002	
Class	23-04	
M/S Eco Cool Home Appliances House No. 56, Shani Gate, Maliwara, Ghaziabad, Uttarpradesh-201001, India, Partners are Pradeep Kumar, Manjeet Singh		
Date of Registration	13/01/2023	
Title	COOLER GRILL	
Priority NA		
Design Number	378706-001	
Class	15-03	
Jangeer Manufacturing Industries Private Limited Near New Dhan Mandi, Anoopgarh Road, Raisinghnagar, (Distt. Sri Ganganagar) Rajasthan.		
Date of Registration	06/02/2023	
Title	THRESHER PARTS	
Priority NA		



Office of the Controller General of Patents, Designs & Trade Marks
Department for Promotion of Industry and Internal Trade
Ministry of Commerce & Industry,
Government of India



Status : Inforce

Inforce upto : 20/07/2032

Design Number	:	368018-001	Filing Date	:	20/07/2022
Type of Application	:	ORDINARY	Class:Subclass	:	24-01
Convention Country/IGO	:		Reciprocity Date	:	
Notification Date	:	10/03/2023		:	
Name of Article	:	MOUTH GUARD FOR THE SCUBA DIVERS			

Sl No	Name of Registered Proprietor	Address
1	Ms. Tejaswi Gadhiraju	KLE Viswanath Katti Institute of Dental Sciences, KLE Academy of Higher Education and Research, Nehru Nagar, Belagavi-590010, Karnataka, India.
2	Dr. Sagar Jalihal	Department of Public Health Dentistry, KLE Viswanath Katti Institute of Dental Sciences, KLE Academy of Higher Education and Research, Nehru Nagar, Belagavi-590010, Karnataka, India
3	Dr. Anil V Ankola	Department of Public Health Dentistry, KLE Viswanath Katti Institute of Dental Sciences, KLE Academy of Higher Education and Research, Nehru Nagar, Belagavi-590010, Karnataka, India.
4	Dr. Ram Surath Kumar K	Department of Public Health Dentistry, KLE Viswanath Katti Institute of Dental Sciences, KLE Academy of Higher Education and Research, Nehru Nagar, Belagavi-590010, Karnataka, India.
5	Ms. Aleena Tom	KLE Viswanath Katti Institute of Dental Sciences, KLE Academy of Higher Education and Research, Nehru Nagar, Belagavi-590010, Karnataka, India.
6	Dr. Atrey J Pai Khot	Department of Public Health Dentistry, KLE Viswanath Katti Institute of Dental Sciences, KLE Academy of Higher Education and Research, Nehru Nagar, Belagavi-590010, Karnataka, India

Address of Service : Ms. Tejaswi Gadhiraju Address -: KLE Viswanath Katti Institute of Dental Sciences, KLE Academy of Higher Education and Research, Nehru Nagar, Belagavi-590010, Karnataka, India.

Additional Address of :

Service

Back

Design Number	361357-001		
Class	29-02		
BMC (Tianjin) Medical Co., Ltd. 3/F, Building No.4, No.1 Xinxing Road,Wuqing District, Tianjin, China			
Date of Registration	28/03/2022		
Title	FRAME FOR RESPIRATORY MASK		
Priority			
Priority Number	Date	Country	
202130656340.0	30/09/2021	China	
Design Number			
367950-001			
Class	28-02		
RENEE COSMETICS PVT. LTD., 4 Om Complex, 2nd Floor, Swastik Char Rasta, C.G.Road, Ahmedabad-380009			
Date of Registration	19/07/2022		
Title	COSMETIC CASE		
Priority NA			
Design Number			
368018-001			
Class	24-01		
1.Ms. Tejaswi Gadhiraaju KLE Viswanath Katti Institute of Dental Sciences, KLE Academy of Higher Education and Research, Nehru Nagar, Belagavi-590010, Karnataka, India. 2. Dr. Sagar Jalihal Department of Public Health Dentistry, KLE Viswanath Katti Institute of Dental Sciences, KLE Academy of Higher Education and Research, Nehru Nagar, Belagavi-590010, Karnataka, India 3. Dr. Anil V Ankola Department of Public Health Dentistry, KLE Viswanath Katti Institute of Dental Sciences, KLE Academy of Higher Education and Research, Nehru Nagar, Belagavi-590010, Karnataka, India. 4. Dr. Ram Surath Kumar K Department of Public Health Dentistry, KLE Viswanath Katti Institute of Dental Sciences, KLE Academy of Higher Education and Research, Nehru Nagar, Belagavi-590010, Karnataka, India. , et al.			
Date of Registration	20/07/2022		
Title	MOUTH GUARD FOR THE SCUBA DIVERS		
Priority NA			



Office of the Controller General of Patents, Designs & Trade Marks
Department for Promotion of Industry and Internal Trade
Ministry of Commerce & Industry,
Government of India



Status : Inforce

Inforce upto : 18/11/2032

Design Number	: 374389-001	Filing Date	: 18/11/2022
Type of Application	: ORDINARY	Class:Subclass	: 24-01
Convention Country/IGO	:	Reciprocity Date	:
Notification Date	: 10/03/2023		:
Name of Article	: TONGUE RETRACTOR WITH INCORPORATED SUCTION		

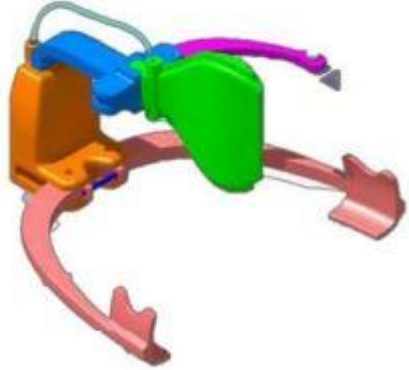
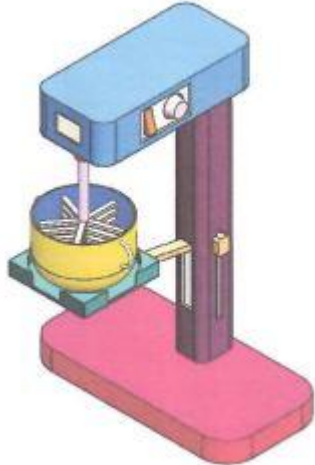

Sl No	Name of Registered Proprietor	Address
1	Dr. Anabelle Louise Veiga Coutinho Fernandes	Department of Oral Medicine and Radiology, Vishwanath Katti Institute of Dental Sciences, KLE Academy of Higher Education and Research, Nehru Nagar, Belagavi-590010 Karnataka India
2	Dr. Arvind Shetti	Department of Oral Medicine and Radiology, Vishwanath Katti Institute of Dental Sciences, KLE Academy of Higher Education and Research, Nehru Nagar, Belagavi-590010 Karnataka India
3	Dr. Ansari Sulem Riyaz Ahmed	Room No.20, Bldg No.21, Parksite Municipal Colony, Vikhroli West, Near Vikhroli bus depot, Mumbai, Maharashtra-400079
4	Dr. Jayraj B. Malik	Department of Oral Medicine and Radiology, Vishwanath Katti Institute of Dental Sciences, KLE Academy of Higher Education and Research, Nehru Nagar, Belagavi-590010Karnataka India
5	Dr. Sridhar M	Department of Oral Medicine and Radiology, Vishwanath Katti Institute of Dental Sciences, KLE Academy of Higher Education and Research, Nehru Nagar, Belagavi-590010Karnataka India
6	Dr. Lokesh Kumar S	13/7, Venkatachalapathy Street, Rajakilpakkam, Chennai-600073
7	Dr. Jayapriya T	Department of Oral Medicine and Radiology, Vishwanath Katti Institute of Dental Sciences, KLE Academy of Higher Education and Research, Nehru Nagar, Belagavi-590010Karnataka India
8	Dr. Atrey Jagdish Pai Khot	Department of Public Health Dentistry, Vishwanath Katti Institute of Dental Sciences, KLE Academy of Higher Education and Research, Nehru Nagar, Belagavi590010Karnataka India

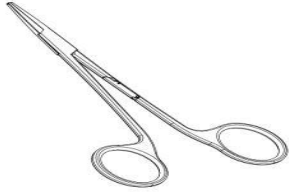


9	Dr. Vaishali Keluskar	Department of Oral Medicine and Radiology, Vishwanath Katti Institute of Dental Sciences, KLE Academy of Higher Education and Research, Nehru Nagar, Belagavi-590010Karnataka India
10	Dr. Tanvi Shukla	Department of Orthodontics and Dentofacial Orthopaedics,Vishwanath Katti Institute of Dental Sciences, KLE Academy of Higher Education and Research, Nehru Nagar, Belagavi- 590010, Karnataka, India
11	Dr. Namit Batra	Department of Orthodontics and Dentofacial Orthopaedics, Vishwanath Katti Institute of Dental Sciences, KLE Academy of Higher Education and Research, Nehru Nagar, Belagavi- 590010, Karnataka, India.


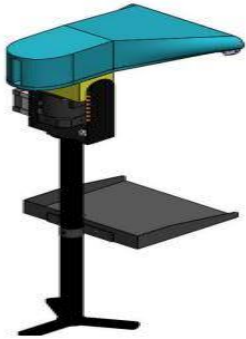
Address of Service : Dr. Anabelle Louise Veiga Coutinho Fernandes Department of Oral Medicine and Radiology, Vishwanath Katti Institute of Dental Sciences, KLE Academy of Higher Education and Research, Nehru Nagar, Be


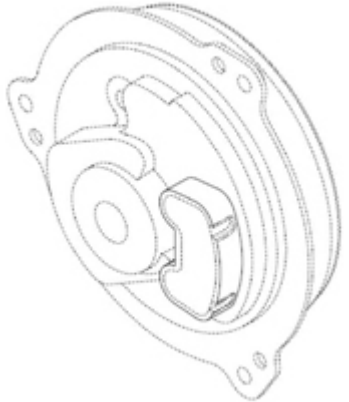
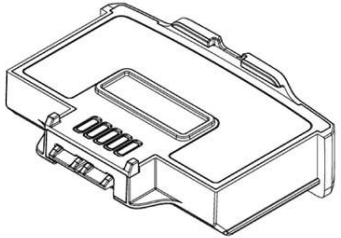
Additional Address of Service :

Back

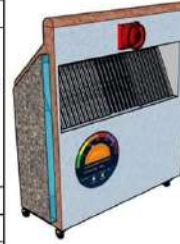
Design Number	374389-001	
Class	24-01	
<p>1. Dr. Anabelle Louise Veiga Coutinho Fernandes Department of Oral Medicine and Radiology, Vishwanath Katti Institute of Dental Sciences, KLE Academy of Higher Education and Research, Nehru Nagar, Belagavi-590010 Karnataka India 2. Dr. Arvind Shetti Department of Oral Medicine and Radiology, Vishwanath Katti Institute of Dental Sciences, KLE Academy of Higher Education and Research, Nehru Nagar, Belagavi-590010 Karnataka India 3. Dr. Ansari Sulem Riyaz Ahmed Room No.20, Bldg No.21, Parksite Municipal Colony, Vikhroli West, Near Vikhroli bus depot, Mumbai, Maharashtra-400079 4. Dr. Jayraj B. Malik Department of Oral Medicine and Radiology, Vishwanath Katti Institute of Dental Sciences, KLE Academy of Higher Education and Research, Nehru Nagar, Belagavi-590010 Karnataka India , et al.</p>		
Date of Registration	18/11/2022	
Title	TONGUE RETRACTOR WITH INCORPORATED SUCTION	
Priority NA		
Design Number	374414-001	
Class	15-09	
<p>1. Dr. Narayan Prasad Gupta Assistant Professor, Electrical Engineering, University Institute of Technology, Rajiv Gandhi Proudyogiki Vishwavidyalaya, Bhopal- 462033 2. Dr .J.Joshua Gnana Sekaran professor , CSI College of Engineering Ketti ooty -643215 3. Mr. AbhraPratip Ray A2-201, Kundan Estate, Pimple Saudagar, PCMC, Pune, Maharashtra 4. Dr Depaa RA B Deputy HoD and Associate Professor, Civil Engineering, Dr MGR Educational and Research Institute, Chennai- 600095 , et al.</p>		
Date of Registration	19/11/2022	
Title	Crushing Machine	
Priority NA		
Design Number	374419-001	
Class	02-02	
<p>Prakash Chand M ,H 146 (1/1-1) ,4 Th Cross, Nagappa Block , Srirampuram, Bangalore 560021 Mob :9341212203</p>		
Date of Registration	20/11/2022	
Title	SAREE	
Priority NA		

Design Number	383653-001	
Class	24-02	
1. Dr. Namit Batra Department of Orthodontics and Dentofacial Orthopaedics KAHER's KLE Vishwanath Katti Institute of Dental Sciences, Constituent Unit of KLE Academy of Higher Education & Research, Nehru Nagar, Belagavi, Karnataka-590010, India 2. Dr. Tanvi Shukla Department of Orthodontics and Dentofacial Orthopaedics KAHER's KLE Vishwanath Katti Institute of Dental Sciences, Constituent Unit of KLE Academy of Higher Education & Research, Nehru Nagar, Belagavi, Karnataka-590010, India 3. Dr. Aravindsamy M Department of Orthodontics and Dentofacial Orthopaedics KAHER's KLE Vishwanath Katti Institute of Dental Sciences, Constituent Unit of KLE Academy of Higher Education & Research, Nehru Nagar, Belagavi, Karnataka-590010, India 4. Dr. Amit Nilgar Department of Orthodontics and Dentofacial Orthopaedics KAHER's KLE Vishwanath Katti Institute of Dental Sciences, Constituent Unit of KLE Academy of Higher Education & Research, Nehru Nagar, Belagavi, Karnataka-590010, India , et al.		
Date of Registration	11/04/2023	
Title	MULTI-UTILITY ORTHODONTIC WIRE TUCKER	
Priority NA		
Design Number	383656-001	
Class	06-01	
Marc Salon & Beauty Equipments Pvt. Ltd. an Indian company of Plot no.86, Sector-5, IMT Manesar, Gurgaon (HR.), India.		
Date of Registration	11/04/2023	
Title	HAIRDRESSER'S CHAIR	
Priority NA		
Design Number	387546-001	
Class	02-02	
SABYASACHI CALCUTTA LLP 80/2 Topsia Road (South), Kolkata-700046, West Bengal.		
Date of Registration	03/06/2023	
Title	LADIES GARMENT (SET)	
Priority NA		

Design Number	387839-001	
Class	24-01	
1. Dr. Adithi Rao Department of Orthodontics and Dentofacial Orthopaedics KAHER'S Vishwanath Katti Institute of Dental Sciences Belagavi, Karnataka -590010 2. Dr. Shreya Mantri Department of Orthodontics and Dentofacial Orthopaedics KAHER'S Vishwanath Katti Institute of Dental Sciences Belagavi, Karnataka -590010 3. Dr. Aditya Acharya Department of Prosthodontics Crown and Bridge KAHER'S Vishwanath Katti Institute of Dental Sciences Belagavi, Karnataka -590010 4. Dr. Tejashri Pradhan Department of Orthodontics and Dentofacial Orthopaedics KAHER'S Vishwanath Katti Institute of Dental Sciences Belagavi, Karnataka -590010		
Date of Registration	07/06/2023	
Title	DIASTEMA CLOSURE WITH TONGUE TRAINING APPLIANCE	
Priority NA		
Design Number	387847-001	
Class	13-03	
Vihan Electric Private Limited Plot no 21, Opp Apple studio, Near Burmashell Petrol Pump, Village Valiv, Vasai (East) Dist: Palghar- 401208		
Date of Registration	07/06/2023	
Title	3 PIN SOCKET	
Priority NA		
Design Number	387855-001	
Class	20-02	
OFFICEDECK TECHNOLOGIES PRIVATE LIMITED 805, A Wing, Arihant Aura, Plot No. 13/1 TTC Industrial Area, Thane-Belapur Road, Turbhe Navi Mumbai Thane MH 400705 India		
Date of Registration	07/06/2023	
Title	Paper Dispenser	
Priority NA		

Design Number	385844-001		
Class	24-02		
Rajesh Suhas Swami Department of Prosthodontics, KAHER's KLE VK Institute of Dental Sciences, Nehru Nagar, Belagavi - 590010			
Date of Registration	09/05/2023		
Title	DENTAL INTER-SHADE MATCHING DEVICE		
Priority NA			
Design Number	340600-001		
Class	13-01		
PANASONIC INTELLECTUAL PROPERTY MANAGEMENT CO., LTD. 1-61, Shiromi 2-chome, Chuo-ku, Osaka-shi, Osaka 540-6207, Japan			
Date of Registration	12/03/2021		
Title	ELECTRIC MOTOR		
Priority			
Priority Number	Date	Country	
2020-019973	18/09/2020	Japan	
Design Number	365870-001		
Class	13-02		
Zebra Technologies Corporation 3 Overlook Point, Lincolnshire, IL 60069, USA			
Date of Registration	10/06/2022		
Title	Battery		
Priority			
Priority Number	Date	Country	
29/820,343	21/12/2021	U.S.A.	

Design Number	390639-001	
Class	21-02	
Sissel International GmbH Roemerstrasse 30/2. Stock 6900 Bregenz Austria		
Date of Registration	19/07/2023	
Title	EXERCISING APPARATUS	
Priority		
Priority Number	Date	Country
015009445-0002	20/01/2023	EU/PO
Design Number	393778-001	
Class	10-04	
1.Mr.:Punit Puri Assistant Professor , ZOOLOGY , DAV COLLEGE JALANDHAR , PUNJAB, 144008-INDIA 2. Dr. V.KANNAN Managing Director, CLDC Research And Development No.997, Mettupalayam Road, Near X-Cut Signal, R.S.Puram, Coimbatore, Tamil Nadu -641002 3. Dr . Manoj AS Head - Planning, Competency Development & Innovations, Government Projects, ICT Academy of Kerala, Trivandrum, Kerala- 695581 4. Dr.V.Gnanaprakash Assistant Professor, Electronics and Communication Engineering, Vel Tech Rangarajan Dr.Sagunthala R&D Institute of Science and Technology, Chennai, Tamilnadu- 600062 , et al.		
Date of Registration	28/08/2023	
Title	Industrial Pollution measurement device	
Priority NA		



Design Number	391967-001	
Class	14-02	
1.GNA University Phagwara-Hoshiarpur Rd, Sri Hargobindgarh, Punjab 144401, India. 2. Anay Goyal Faculty of Engineering, Design and Automation (FEDA-D), GNA University, Phagwara-Hoshiarpur Rd, Sri Hargobindgarh, Punjab 144401, India.		
Date of Registration	04/08/2023	
Title	MOUSE WITH WRIST PAD	
Priority NA		
Design Number	394817-001	
Class	24-04	
1. Dr. Akin Kulangara Korath Department of Orthodontics and Dentofacial, Orthopedics, Vishwanath Katti Institute of, Dental Sciences, KLE Academy of Higher Education and Research, Nehru Nagar, Belagavi-590010 Karnataka India 2. Dr. Charles Jude Department of Orthodontics and Dentofacial, Orthopedics, Vishwanath Katti Institute of Dental Sciences, KLE Academy of Higher Education and Research, Nehru Nagar, Belagavi-590010 Karnataka India 3. Dr. Rohan Hattarki Department of Orthodontics and Dentofacial, Orthopedics, Vishwanath Katti Institute of Dental Sciences, KLE Academy of Higher Education and Research, Nehru Nagar, Belagavi-590010 Karnataka India 4. Dr. Atrey Jagdish Pai Khot Department of Public Health Dentistry, Vishwanath Katti Institute of Dental Sciences, KLE Academy of Higher Education and Research, Nehru Nagar, Belagavi-590010 Karnataka India		
Date of Registration	11/09/2023	
Title	SELF-ACTIVATION SCREW INCORPORATED WRAP-AROUND RETAINER	
Priority NA		
Design Number	395013-001	
Class	23-04	
CROMPTON GREAVES CONSUMER ELECTRICALS LIMITED Equinox Business Park, Tower 3, 1st Floor, East Wing, LBS Marg, Kurla (West), Mumbai 400 070, Maharashtra, India.		
Date of Registration	13/09/2023	
Title	Ceiling Fan	
Priority NA		





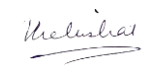
FORM – 1
Application for Registration of Designs.
Sections 5 and 44

You are requested to register the accompanying in;

Class No 24 - 01 in the name, ;

Dr. Jayraj B. Malik	Department of Oral Medicine and Radiology, KAHER's KLE Vishwanath Katti Institute of Dental Sciences, Constituent Unit of KLE Academy of Higher Education and Research, Nehru Nagar, Belagavi, Karnataka -590010
Dr. Vaishali Keluskar	Department of Oral Medicine and Radiology, KAHER's KLE Vishwanath Katti Institute of Dental Sciences, Constituent Unit of KLE Academy of Higher Education and Research, Nehru Nagar, Belagavi, Karnataka -590010
Dr. Shivayogi Charantimath	Department of Oral Medicine and Radiology, KAHER's KLE Vishwanath Katti Institute of Dental Sciences, Constituent Unit of KLE Academy of Higher Education and Research, Nehru Nagar, Belagavi, Karnataka -590010
Dr. Namratha Patil	Department of Oral Medicine and Radiology, KAHER's KLE Vishwanath Katti Institute of Dental Sciences, Constituent Unit of KLE Academy of Higher Education and Research, Nehru Nagar, Belagavi, Karnataka -590010
Dr. Anabelle Louise Veiga Coutinho Fernandes	Department of Oral Medicine and Radiology, KAHER's KLE Vishwanath Katti Institute of Dental Sciences, Constituent Unit of KLE Academy of Higher Education and Research, Nehru Nagar, Belagavi, Karnataka -590010
Dr. Ansari Sulem Riyaz Ahmed	Department of Oral Medicine and Radiology, KAHER's KLE Vishwanath Katti Institute of Dental Sciences, Constituent Unit of KLE Academy of Higher Education and Research, Nehru Nagar, Belagavi, Karnataka -590010
Dr. Lokesh Kumar S	Department of Oral Medicine and Radiology, KAHER's KLE Vishwanath Katti Institute of Dental Sciences, Constituent Unit of KLE Academy of Higher Education and Research, Nehru Nagar, Belagavi, Karnataka -590010
Dr. Sridhar M	Department of Oral Medicine and Radiology, KAHER's KLE Vishwanath Katti Institute of Dental Sciences, Constituent Unit of KLE Academy of Higher Education and Research, Nehru Nagar, Belagavi, Karnataka -590010
Dr. Jayapriya T	Department of Oral Medicine and Radiology, KAHER's KLE Vishwanath Katti Institute of Dental Sciences, Constituent Unit of KLE Academy of Higher Education and Research, Nehru Nagar, Belagavi, Karnataka -590010

Design Number	382975-001	
Class	24-01	
1. Dr. Jayraj B. Malik Department of Oral Medicine and Radiology, KAHER's KLE Vishwanath Katti Institute of Dental Sciences, Constituent Unit of KLE Academy of Higher Education and Research, Nehru Nagar, Belagavi, Karnataka -590010 2. Dr. Vaishali Keluskar Department of Oral Medicine and Radiology, KAHER's KLE Vishwanath Katti Institute of Dental Sciences, Constituent Unit of KLE Academy of Higher Education and Research, Nehru Nagar, Belagavi, Karnataka -590010 3. Dr. Shivayogi Charantimath Department of Oral Medicine and Radiology, KAHER's KLE Vishwanath Katti Institute of Dental Sciences, Constituent Unit of KLE Academy of Higher Education and Research, Nehru Nagar, Belagavi, Karnataka -590010 4. Dr. Namratha Patil Department of Oral Medicine and Radiology, KAHER's KLE Vishwanath Katti Institute of Dental Sciences, Constituent Unit of KLE Academy of Higher Education and Research, Nehru Nagar, Belagavi, Karnataka -590010 , et al.		
Date of Registration	04/04/2023	
Title	PAEDIATRIC SYRINGE WITH EXTENSION	
Priority NA		

Dr. Atrey Jagdish Pai Khot	Department of Oral Medicine and Radiology, KAHER's KLE Vishwanath Katti Institute of Dental Sciences, Constituent Unit of KLE Academy of Higher Education and Research, Nehru Nagar, Belagavi, Karnataka -590010
Dr. Tanvi Shukla	Department of Oral Medicine and Radiology, KAHER's KLE Vishwanath Katti Institute of Dental Sciences, Constituent Unit of KLE Academy of Higher Education and Research, Nehru Nagar, Belagavi, Karnataka -590010
Dr Namit Batra	Department of Oral Medicine and Radiology, KAHER's KLE Vishwanath Katti Institute of Dental Sciences, Constituent Unit of KLE Academy of Higher Education and Research, Nehru Nagar, Belagavi, Karnataka -590010
who claim(s) to be the proprietor(s) thereof Category of Applicant : Natural Person (<input checked="" type="radio"/>) Small entity (<input type="radio"/>) Others (<input type="radio"/>)	
Four exactly similar DRAWINGS of the design accompany this request.	
The design is to be applied for a new design of the	PAEDIATRIC SYRINGE WITH EXTENSION
The design has been previously registered in Classe(s) _____ Under No _____ Details of first application in UK or convention country or group of countries or	
(i) Name of Country :	
(ii) Official date :	
(iii) Official number :	
Address For Service In India Is –	Name : Dr. Jayraj B. Malik Address: Department of Oral Medicine and Radiology, Vishwanath Katti Institute of Dental Sciences, KLE Academy of Higher Education and Research, Nehru Nagar, Belagavi-590010Karnataka India EmailID: aadhyadee25@gmail.com Phone no : 8905298150
Declaration : The applicant claims to be the proprietors of the design and that to the best of their knowledge and belief design is new or original	
Dated this 20 MAR 2023	
Sign, (Applicant)	
Dr. Jayraj B. Malik 	
Dr. Vaishali K Keluskar 	

Dr. Shivayogi Charantimath *S.M. Charantimath*

Dr. Namrata Patil *N. Patil*

Dr. Anabelle Louise Veiga Coutinho Fernandes *Fernandes*

Dr. Ansari Sulem Riyaz Ahmed *S. Riyaz*

Dr. Lokesh Kumar S *L. Kumar*

Dr. Sridhar M *S. Sridhar*

Dr. Jayapriya T *T. Jayapriya*

Dr. Atrey Jagdish Pai Khot *A. Khot*

Dr. Tanvi Shukla *Tanvi Shukla*

Dr. Namit Batra *N. Batra*

**TO
THE CONTROLLER OF DESIGNS,
THE PATENT OFFICE, KOLKATA**

Dr. Jayraj B. Malik
Dr. Vaishali K Keluskar
Dr. Shivayogi Charantimath
Dr. Namrata Patil
Dr. Anabelle Louise Veiga Coutinho Fernandes
Dr. Ansari Sulem Riyaz Ahmed
Dr. Lokesh Kumar S
Dr. Sridhar M
Dr. Jayapriya T
Dr. Atrey Jagdish Pai Khot
Dr. Tanvi Shukla
Dr. Namit Batra

We have invented a new design of a **PAEDIATRIC SYRINGE WITH EXTENSION** as set forth in the following specification. The claimed portion of the design of the **PAEDIATRIC SYRINGE WITH EXTENSION** consists of consists of four parts; syringe, a transparent extension tube with a grip for stability, needle and a baby shark syringe sleeve. Baby shark sleeve is used as it will appear cheerful. It is detachable and covers the upper portion of the needle. Lower portion of the syringe is not covered and shows the markings present on the syringe. The syringe and needle are connected by the extension tube. This device was developed to administer local anaesthesia in paediatric patients with fear of syringes.

Figure 1 is a Front View of a “**PAEDIATRIC SYRINGE WITH EXTENSION**” of our new design;

Figure 2 is a Rear View thereof;

Figure 3 is a Top View thereof;

Figure 4 is a Bottom View thereof;

Figure 5 is a Left Side View thereof.

Figure 6 is the Right Side View thereof;

Figure 7 is the Perspective View thereof;

Dated :20 MAR 2023

Sign, (Applicant)

Dr. Jayraj B. Malik

Dr. Vaishali K Keluskar

Dr. Shivayogi Charantimath

Dr. Namrata Patil

Dr. Anabelle Louise Veiga Coutinho Fernandes

Dr. Ansari Sulem Riyaz Ahmed

Dr. Lokesh Kumar S

Dr. Sridhar M

Dr. Jayapriya T

Dr. Atrey Jagdish Pai Khot

Dr. Tanvi Shukla

Dr. Namit Batra

Dr. Jayraj B. Malik
Dr. Vaishali K Keluskar
Dr. Shivayogi Charantimath
Dr. Namrata Patil
Dr. Anabelle Louise Veiga Coutinho Fernandes
Dr. Ansari Sulem Riyaz Ahmed
Dr. Lokesh Kumar S
Dr. Sridhar M
Dr. Jayapriya T
Dr. Atrey Jagdish Pai Khot
Dr. Tanvi Shukla
Dr. Namit Batra

We Claim that:













The novelty resides in the shape and configuration of the **“PAEDIATRIC SYRINGE WITH EXTENSION”** as illustrated

No claim is made by virtue of this registration in respect of any mechanical or other action of any mechanism whatever or in respect of any mode or principle of construction of the Article.

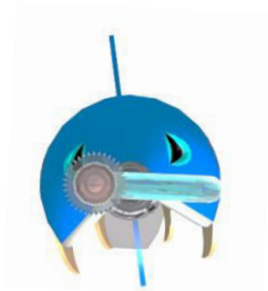
No claim is made by virtue of this registration to any right to the exclusive use of the words, letters, numbers, Color or trademarks appearing in the representation.

Dated :20 MAR 2023

Sign, (Applicant)

Dr. Jayraj B. Malik 
Dr. Vaishali K Keluskar 
Dr. Shivayogi Charantimath 
Dr. Namrata Patil 
Dr. Anabelle Louise Veiga Coutinho Fernandes 
Dr. Ansari Sulem Riyaz Ahmed 
Dr. Lokesh Kumar S 
Dr. Sridhar M 
Dr. Jayapriya T 
Dr. Atrey Jagdish Pai Khot 
Dr. Tanvi Shukla 
Dr. Namit Batra 

Dr. Jayraj B. Malik
Dr. Vaishali K Keluskar
Dr. Shivayogi Charantimath
Dr. Namrata Patil
Dr. Anabelle Louise Veiga Coutinho Fernandes
Dr. Ansari Sulem Riyaz Ahmed
Dr. Lokesh Kumar S
Dr. Sridhar M
Dr. Jayapriya T
Dr. Atrey Jagdish Pai Khot
Dr. Tanvi Shukla
Dr. Namit Batra



FRONT VIEW

We Claim that:

The novelty resides in the shape and configuration of the “**PAEDIATRIC SYRINGE WITH EXTENSION**” as illustrated

No claim is made by virtue of this registration in respect of any mechanical or other action of any mechanism whatever or in respect of any mode or principle of construction of the Article

No claim is made by virtue of this registration to any right to the exclusive use of the words, letters, numbers, Color, or trademarks appearing in the representation.

Dated 20 MAR 2023

Sign, (Applicant)

Dr. Jayraj B. Malik *Jayraj*
Dr. Vaishali K Keluskar *Keluskar*
Dr. Shivayogi Charantimath *S. Charantimath*
Dr. Namrata Patil *N. Patil*
Dr. Anabelle Louise Veiga Coutinho Fernandes *A. Fernandes*
Dr. Ansari Sulem Riyaz Ahmed *A. Ahmed*
Dr. Lokesh Kumar S *L. Kumar*
Dr. Sridhar M *S. M.*
Dr. Jayapriya T *J. Jayapriya*
Dr. Atrey Jagdish Pai Khot *A. Khot*
Dr. Tanvi Shukla *T. Shukla*
Dr. Namit Batra *N. Batra*

Dr. Jayraj B. Malik
 Dr. Vaishali K Keluskar
 Dr. Shivayogi Charantimath
 Dr. Namrata Patil
 Dr. Anabelle Louise Veiga Coutinho Fernandes
 Dr. Ansari Sulem Riyaz Ahmed
 Dr. Lokesh Kumar S
 Dr. Sridhar M
 Dr. Jayapriya T
 Dr. Atrey Jagdish Pai Khot
 Dr. Tanvi Shukla
 Dr. Namit Batra



REAR VIEW

We Claim that:

The novelty resides in the shape and configuration of the “**PAEDIATRIC SYRINGE WITH EXTENSION**” as illustrated

No claim is made by virtue of this registration in respect of any mechanical or other action of any mechanism whatever or in respect of any mode or principle of construction of the Article

No claim is made by virtue of this registration to any right to the exclusive use of the words, letters, numbers, Color, or trademarks appearing in the representation.

Dated 20 MAR 2023

Sign, (Applicant)

Dr. Jayraj B. Malik *Jayraj*
 Dr. Vaishali K Keluskar *Keluskar*
 Dr. Shivayogi Charantimath *S. Charantimath*
 Dr. Namrata Patil *N. Patil*
 Dr. Anabelle Louise Veiga Coutinho Fernandes *A. Fernandes*
 Dr. Ansari Sulem Riyaz Ahmed *A. Ahmed*
 Dr. Lokesh Kumar S *L. Kumar*
 Dr. Sridhar M *S. M.*
 Dr. Jayapriya T *J. Jayapriya*
 Dr. Atrey Jagdish Pai Khot *A. Khot*
 Dr. Tanvi Shukla *T. Shukla*
 Dr. Namit Batra *N. Batra*

Dr. Jayraj B. Malik
 Dr. Vaishali K Keluskar
 Dr. Shivayogi Charantimath
 Dr. Namrata Patil
 Dr. Anabelle Louise Veiga Coutinho Fernandes
 Dr. Ansari Sulem Riyaz Ahmed
 Dr. Lokesh Kumar S
 Dr. Sridhar M
 Dr. Jayapriya T
 Dr. Atrey Jagdish Pai Khot
 Dr. Tanvi Shukla
 Dr. Namit Batra



TOP VIEW

We Claim that:

The novelty resides in the shape and configuration of the “**PAEDIATRIC SYRINGE WITH EXTENSION**” as illustrated

No claim is made by virtue of this registration in respect of any mechanical or other action of any mechanism whatever or in respect of any mode or principle of construction of the Article

No claim is made by virtue of this registration to any right to the exclusive use of the words, letters, numbers, Color, or trademarks appearing in the representation.

Dated 20 MAR 2023

Sign, (Applicant)

Dr. Jayraj B. Malik *JMalik*
 Dr. Vaishali K Keluskar *Keluskar*
 Dr. Shivayogi Charantimath *S.Charrantimath*
 Dr. Namrata Patil *N.Patil*
 Dr. Anabelle Louise Veiga Coutinho Fernandes *A.Fernandes*
 Dr. Ansari Sulem Riyaz Ahmed *A.Ahmed*
 Dr. Lokesh Kumar S *L.Kumar*
 Dr. Sridhar M *S.M*
 Dr. Jayapriya T *J.Priya*
 Dr. Atrey Jagdish Pai Khot *A.Khot*
 Dr. Tanvi Shukla *T.Shukla*
 Dr. Namit Batra *N.Batra*

Dr. Jayraj B. Malik
 Dr. Vaishali K Keluskar
 Dr. Shivayogi Charantimath
 Dr. Namrata Patil
 Dr. Anabelle Louise Veiga Coutinho Fernandes
 Dr. Ansari Sulem Riyaz Ahmed
 Dr. Lokesh Kumar S
 Dr. Sridhar M
 Dr. Jayapriya T
 Dr. Atrey Jagdish Pai Khot
 Dr. Tanvi Shukla
 Dr. Namit Batra



BOTTOM VIEW

We Claim that:

The novelty resides in the shape and configuration of the “**PAEDIATRIC SYRINGE WITH EXTENSION**” as illustrated

No claim is made by virtue of this registration in respect of any mechanical or other action of any mechanism whatever or in respect of any mode or principle of construction of the Article

No claim is made by virtue of this registration to any right to the exclusive use of the words, letters, numbers, Color, or trademarks appearing in the representation.

Dated 20 MAR 2023

Sign, (Applicant)

Dr. Jayraj B. Malik *JM*
 Dr. Vaishali K Keluskar *VK*
 Dr. Shivayogi Charantimath *S.C.*
 Dr. Namrata Patil *N.P.*
 Dr. Anabelle Louise Veiga Coutinho Fernandes *A.L.V.C.F.*
 Dr. Ansari Sulem Riyaz Ahmed *A.S.R.A.*
 Dr. Lokesh Kumar S *L.K.S.*
 Dr. Sridhar M *S.M.*
 Dr. Jayapriya T *J.P.T.*
 Dr. Atrey Jagdish Pai Khot *A.J.P.K.*
 Dr. Tanvi Shukla *T.S.*
 Dr. Namit Batra *N.B.*

Dr. Jayraj B. Malik
 Dr. Vaishali K Keluskar
 Dr. Shivayogi Charantimath
 Dr. Namrata Patil
 Dr. Anabelle Louise Veiga Coutinho Fernandes
 Dr. Ansari Sulem Riyaz Ahmed
 Dr. Lokesh Kumar S
 Dr. Sridhar M
 Dr. Jayapriya T
 Dr. Atrey Jagdish Pai Khot
 Dr. Tanvi Shukla
 Dr. Namit Batra



LEFT VIEW

We Claim that:

The novelty resides in the shape and configuration of the “**PAEDIATRIC SYRINGE WITH EXTENSION**” as illustrated

No claim is made by virtue of this registration in respect of any mechanical or other action of any mechanism whatever or in respect of any mode or principle of construction of the Article

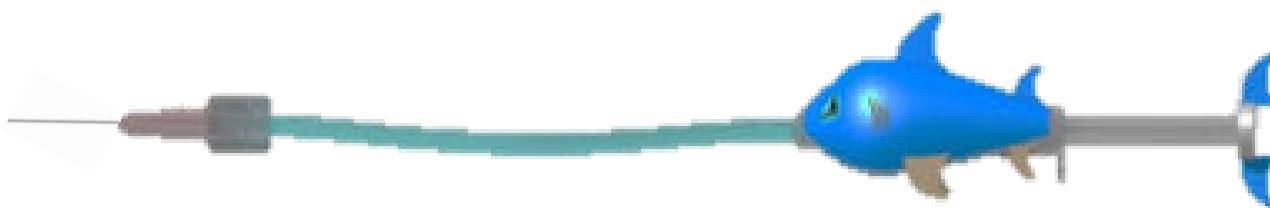
No claim is made by virtue of this registration to any right to the exclusive use of the words, letters, numbers, Color, or trademarks appearing in the representation.

Dated 20 MAR 2023

Sign, (Applicant)

Dr. Jayraj B. Malik *Jayraj*
 Dr. Vaishali K Keluskar *Keluskar*
 Dr. Shivayogi Charantimath *S. Charantimath*
 Dr. Namrata Patil *N. Patil*
 Dr. Anabelle Louise Veiga Coutinho Fernandes *A. Fernandes*
 Dr. Ansari Sulem Riyaz Ahmed *A. Ahmed*
 Dr. Lokesh Kumar S *L. Kumar*
 Dr. Sridhar M *S. M.*
 Dr. Jayapriya T *J. Jayapriya*
 Dr. Atrey Jagdish Pai Khot *A. Khot*
 Dr. Tanvi Shukla *T. Shukla*
 Dr. Namit Batra *N. Batra*

Dr. Jayraj B. Malik
 Dr. Vaishali K Keluskar
 Dr. Shivayogi Charantimath
 Dr. Namrata Patil
 Dr. Anabelle Louise Veiga Coutinho Fernandes
 Dr. Ansari Sulem Riyaz Ahmed
 Dr. Lokesh Kumar S
 Dr. Sridhar M
 Dr. Jayapriya T
 Dr. Atrey Jagdish Pai Khot
 Dr. Tanvi Shukla
 Dr. Namit Batra



RIGHT VIEW

We Claim that:

The novelty resides in the shape and configuration of the “**PAEDIATRIC SYRINGE WITH EXTENSION**” as illustrated

No claim is made by virtue of this registration in respect of any mechanical or other action of any mechanism whatever or in respect of any mode or principle of construction of the Article

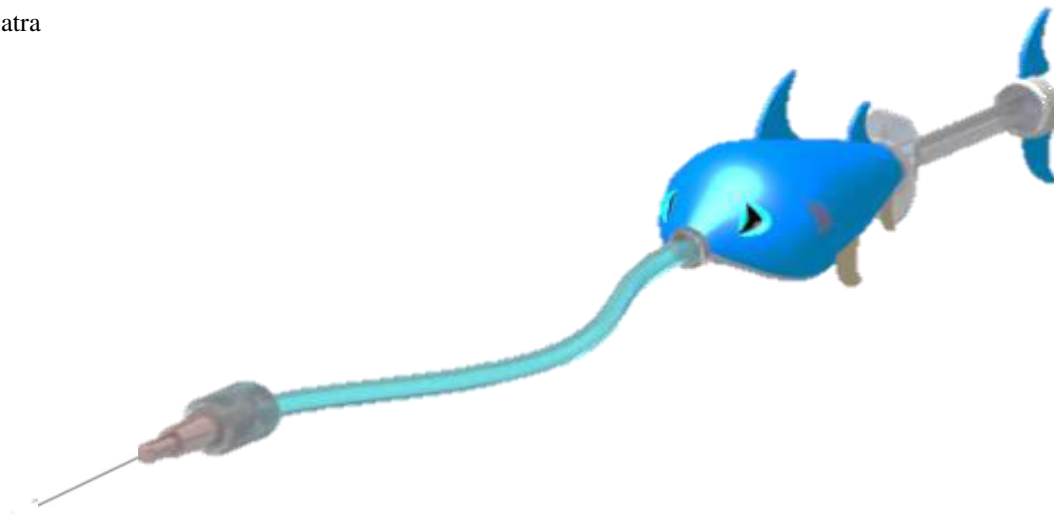
No claim is made by virtue of this registration to any right to the exclusive use of the words, letters, numbers, Color, or trademarks appearing in the representation.

Dated 20 MAR 2023

Sign, (Applicant)

Dr. Jayraj B. Malik *Jayraj*
 Dr. Vaishali K Keluskar *Keluskar*
 Dr. Shivayogi Charantimath *S. Charantimath*
 Dr. Namrata Patil *N. Patil*
 Dr. Anabelle Louise Veiga Coutinho Fernandes *A. Fernandes*
 Dr. Ansari Sulem Riyaz Ahmed *A. Ahmed*
 Dr. Lokesh Kumar S *L. Kumar*
 Dr. Sridhar M *S. M.*
 Dr. Jayapriya T *J. Jayapriya*
 Dr. Atrey Jagdish Pai Khot *A. Khot*
 Dr. Tanvi Shukla *T. Shukla*
 Dr. Namit Batra *N. Batra*

Dr. Jayraj B. Malik
 Dr. Vaishali K Keluskar
 Dr. Shivayogi Charantimath
 Dr. Namrata Patil
 Dr. Anabelle Louise Veiga Coutinho Fernandes
 Dr. Ansari Sulem Riyaz Ahmed
 Dr. Lokesh Kumar S
 Dr. Sridhar M
 Dr. Jayapriya T
 Dr. Atrey Jagdish Pai Khot
 Dr. Tanvi Shukla
 Dr. Namit Batra



PERSPECTIVE VIEW

We Claim that:

The novelty resides in the shape and configuration of the “**PAEDIATRIC SYRINGE WITH EXTENSION**” as illustrated

No claim is made by virtue of this registration in respect of any mechanical or other action of any mechanism whatever or in respect of any mode or principle of construction of the Article

No claim is made by virtue of this registration to any right to the exclusive use of the words, letters, numbers, Color, or trademarks appearing in the representation.

Dated 20 MAR 2023

Sign, (Applicant)

Dr. Jayraj B. Malik *Jayraj*
 Dr. Vaishali K Keluskar *Keluskar*
 Dr. Shivayogi Charantimath *S. Charantimath*
 Dr. Namrata Patil *N. Patil*
 Dr. Anabelle Louise Veiga Coutinho Fernandes *A. Fernandes*
 Dr. Ansari Sulem Riyaz Ahmed *A. Ahmed*
 Dr. Lokesh Kumar S *L. Kumar*
 Dr. Sridhar M *S. M.*
 Dr. Jayapriya T *J. Jayapriya*
 Dr. Atrey Jagdish Pai Khot *A. Khot*
 Dr. Tanvi Shukla *T. Shukla*
 Dr. Namit Batra *N. Batra*

Design Number	395343-001	
Class	23-03	
Polycab India Limited Unit 4, Plot No 105, Halol Vadodara Road, Village Nurpura, Taluka Halol, Panchmahal-389350. Gujarat		
Date of Registration	18/09/2023	
Title	WATER HEATER	
Priority NA		
Design Number	368016-001	
Class	23-03	
SVI Carbon Private Limited A-199, Ground Floor, Defence Colony, New Delhi-110024, India.		
Date of Registration	19/07/2022	
Title	Graphite Block	
Priority NA		
Design Number	396410-001	
Class	24-02	
Rajesh Suhas Swami Department of Prosthodontics, KAHER's KLE VK Institute of Dental Sciences and Hospital		
Date of Registration	30/09/2023	
Title	POSTERIORLY EXTENDED INCISAL PIN IN DENTAL ARTICULATOR	
Priority NA		

FORM – 1
Application for Registration of Designs.
Sections 5 and 44

You are requested to register the accompanying in;

Class No 24 - 01 in the name, ;

Rohan S Hattarki

Department of Orthodontics and Dentofacial Orthopaedics,
KLE Vishwanath Katti Institute of Dental Sciences, KLE
Academy of Higher Education and Research, Belagavi-590010,
Karnataka-India

Susmita Bala Sheno

Department of Orthodontics and Dentofacial
Orthopedics, KLE Vishwanath Katti Institute of
Dental Sciences, Nehru Nagar, Belagavi-590010,
Karnataka-

who claim(s) to be the proprietor(s) thereof

Category of Applicant : Natural Person () Small entity () Others ()

Four exactly similar **DRAWINGS** of the design accompany this request.

The design is to be applied for a new design of the

DENTAL BRACKET POSITIONING JIGS

The design has been previously registered in

Class(es) _____ Under No _____

Details of first application in UK or convention country or group of countries or

(i) Name of Country :

(ii) Official date :

(iii) Official number :

Address For Service In India Is –

Name : Dr. Nagendra Singh

Address: Associate Professor Department of Electrical &
Electronics Engineering, Trinity College of Engineering
& Technology, Karimnagar, TS

EmailID: drrohanhattarki@gmail.com

Phone no:

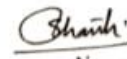
Declaration :

The applicant claims to be the proprietors of the design and that to the best of their knowledge and belief design is new or original

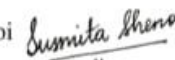
Dated 07 OCT 2023

Sign, (Applicant)




Rohan S Hattarki



Susmita Bala Sheno



TO
THE CONTROLLER OF DESIGNS,
THE PATENT OFFICE, KOLKATA

Design Number	398482-001	
Class	15-03	
1. Apurva Tripathi Farmer, Advocate, G14, Herbal Estate, Maa Danteshwari Herbal Office, Near HR Tower, Agroha Colony, Ringroad-1, Raipur-492001, Chhattisgarh, India. 2. Rutuja Nitin Sonawane Modern College of Arts, Science and Commerce (Autonomous) Shivajinagar, Pune-05 Maharashtra India 3. Dr. Akalesh Kumar Verma Assistant Professor, Department of Zoology, Cell and Biochemical Technology Laboratory, Cotton University, Panbazar, Guwahati- 781001, Assam 4. Mr. Chetan Sharad Sanap Mahatma Gandhi Vidyamandir's. Loknete Vyankatrao Hiray Arts, Science and Commerce College, Panchavati, Nashik-422003. , et al.		
Date of Registration	26/10/2023	
Title	FUNGICIDE COATING SEED TREATING BOX	
Priority NA		
Design Number	398483-001	
Class	24-01	
Hiteshkumar Shantilal Agrawal Plot No. 42, Manmohan Nagar, Nandurbar 425412		
Date of Registration	26/10/2023	
Title	TUBERCULOSIS MEDICATION DISPENSING DEVICE	
Priority NA		
Design Number	398484-001	
Class	24-01	
1. Rohan S Hattarki Department of Orthodontics and Dentofacial Orthopedics, KLE Vishwanath Katti Institute of Dental Sciences, KLE Academy of Higher Education and Research, Belagavi-590010, Karnataka-India 2. Susmita Bala Sheno Department of Orthodontics and Dentofacial Orthopedics, KLE Vishwanath Katti Institute of Dental Sciences, Nehru Nagar, Belagavi-590010, Karnataka		
Date of Registration	26/10/2023	
Title	DENTAL BRACKET POSITIONING JIGS	
Priority NA		



ORIGINAL
क्रम सं/ Serial No. : 150749



पेटेंट कार्यालय, भारत सरकार | The Patent Office, Government Of India

डिजाइन के पंजीकरण का प्रमाण पत्र | Certificate of Registration of Design

डिजाइन सं. / Design No. 398484-001

तारीख / Date 26/10/2023

पारस्परिकता तारीख / Reciprocity Date *

देश / Country

प्रमाणित किया जाता है कि संलग्न प्रति में वर्णित डिजाइन जो **DENTAL BRACKET POSITIONING JIGS** से संबंधित है, का पंजीकरण, श्रेणी 24-01 में 1.Rohan S Hattarki 2. Susmita Bala Shenoi के नाम में उपर्युक्त संख्या और तारीख में कर लिया गया है।

Certified that the design of which a copy is annexed hereto has been registered as of the number and date given above in class 24-01 in respect of the application of such design to **DENTAL BRACKET POSITIONING JIGS** in the name of 1.Rohan S Hattarki 2. Susmita Bala Shenoi.

डिजाइन अधिनियम, 2000 तथा डिजाइन नियम, 2001 के अध्याधीन प्रावधानों के अनुसरण में।

In pursuance of and subject to the provisions of the Designs Act, 2000 and the Designs Rules, 2001.



(Signature)

महानियंत्रक पेटेंट, डिजाइन और व्यापार चिह्न
Controller General of Patents, Designs and Trade Marks

जारी करने की तिथि : 22/12/2023
Date of Issue

*पारस्परिकता तारीख (यदि कोई हो) जिसकी अनुमति दी गई है तथा देश का नाम। डिजाइन का स्वत्वाधिकार पंजीकरण की तारीख से दस वर्षों के लिए होगा जिसका विस्तार, अधिनियम एवं नियम के निबंधनों के अधीन, पाँच वर्षों की अतिरिक्त अवधि के लिए किया जा सकेगा। इस प्रमाण पत्र का उपयोग विधिक कार्यवाहियों अथवा विदेश में पंजीकरण प्राप्त करने के लिए नहीं हो सकता है।
The reciprocity date (if any) which has been allowed and the name of the country. Copyright in the design will subsist for ten years from the date of Registration, and may under the terms of the Act and Rules, be extended for a further period of five years. This Certificate is not for use in legal proceedings or for obtaining registration abroad.



ORIGINAL

मूल/No : 133829



भारत सरकार
GOVERNMENT OF INDIA
पेटेंट कार्यालय
THE PATENT OFFICE

डिजाइन के पंजीकरण का प्रमाणपत्र
CERTIFICATE OF REGISTRATION OF DESIGN

डिजाइन सं. / Design No. : 363757-001
तारीख / Date : 05/05/2022
पारस्परिकता तारीख / Reciprocity Date* :
देश / Country :

प्रमाणित किया जाता है कि संलग्न प्रति में वर्णित डिजाइन जो **A NOVEL BURN WOUND HEALING APPARATUS** से संबंधित है, का पंजीकरण, श्रेणी **24-04** में 1.Sunil Jalalpore 2. Bhaskar Kurangi 3.Dnyaneshwar Nirmale के नाम में उपर्युक्त संख्या और तारीख में कर लिया गया है।

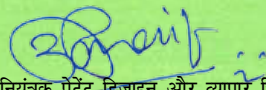
Certified that the design of which a copy is annexed hereto has been registered as of the number and date given above in class **24-04** in respect of the application of such design to **A NOVEL BURN WOUND HEALING APPARATUS** in the name of 1.Sunil Jalalpore 2. Bhaskar Kurangi 3.Dnyaneshwar Nirmale.

डिजाइन अधिनियम, 2000 तथा डिजाइन नियम, 2001 के अध्याधीन प्रावधानों के अनुसरण में।

In pursuance of and subject to the provisions of the Designs Act, 2000 and the Designs Rules, 2001.

INTELLECTUAL
PROPERTY INDIA
PATENTS | DESIGNS | TRADE MARKS
GEOGRAPHICAL INDICATIONS

निर्गमन की तारीख/Date of Issue : 25/04/2023


महानियंत्रक पेटेंट डिजाइन और व्यापार चिह्न
Controller General of Patents, Designs and Trade Marks

पारस्परिकता तारीख (यदि कोई हो) जिसकी अनुमति देश के नाम पर की गई है। डिजाइन का सत्त्वाधिकार पंजीकरण की तारीख से दस वर्षों के लिए होगा जिसका विस्तार, अधिनियम एवं नियम के निबंधनों के अधीन, पाँच वर्षों की अतिरिक्त अवधि के लिए किया जा सकेगा। इस प्रमाण पत्र का उपयोग विधिक कार्यवाहियों अथवा विदेश में पंजीकरण प्राप्त करने के लिए नहीं हो सकता है।

*The reciprocity date (if any) which has been allowed and the name of the country. Copyright in the design will subsist for ten years from the date of Registration, and may under the terms of the Act and Rules, be extended for a further period of five years. This Certificate is not for use in legal proceedings or for obtaining registration abroad.



ORIGINAL

मूल/No : 129035



भारत सरकार
GOVERNMENT OF INDIA
पेटेंट कार्यालय
THE PATENT OFFICE

डिजाइन के पंजीकरण का प्रमाणपत्र
CERTIFICATE OF REGISTRATION OF DESIGN

डिजाइन सं. / Design No. : 375862-001
तारीख / Date : 20/12/2022
पारस्परिकता तारीख / Reciprocity Date* :
देश / Country :

प्रमाणित किया जाता है कि संलग्न प्रति में वर्णित डिजाइन जो **CAGE FOR RODENTS** से संबंधित है, का पंजीकरण, श्रेणी **30-02** में 1.Sunil Jalalpure 2. Bhaskar Kurangi 3.Dnyaneshwar Nirmale 4.Swapnil Patil 5.Suneel Dodamani के नाम में उपर्युक्त संख्या और तारीख में कर लिया गया है।

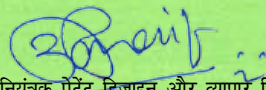
Certified that the design of which a copy is annexed hereto has been registered as of the number and date given above in class **30-02** in respect of the application of such design to **CAGE FOR RODENTS** in the name of 1.Sunil Jalalpure 2. Bhaskar Kurangi 3.Dnyaneshwar Nirmale 4.Swapnil Patil 5.Suneel Dodamani.

डिजाइन अधिनियम, 2000 तथा डिजाइन नियम, 2001 के अध्याधीन प्रावधानों के अनुसरण में।

In pursuance of and subject to the provisions of the Designs Act, 2000 and the Designs Rules, 2001.

INTELLECTUAL
PROPERTY INDIA
PATENTS | DESIGNS | TRADE MARKS
GEOGRAPHICAL INDICATIONS

निर्गमन की तारीख/Date of Issue : 13/02/2023


महानियंत्रक पेटेंट डिजाइन और व्यापार चिह्न
Controller General of Patents, Designs and Trade Marks

पारस्परिकता तारीख (यदि कोई हो) जिसकी अनुमति देश के नाम पर की गई है। डिजाइन का सत्त्वाधिकार पंजीकरण की तारीख से दस वर्षों के लिए होगा जिसका विस्तार, अधिनियम एवं नियम के निबंधनों के अधीन, पाँच वर्षों की अतिरिक्त अवधि के लिए किया जा सकेगा। इस प्रमाण पत्र का उपयोग विधिक कार्यवाहियों अथवा विदेश में पंजीकरण प्राप्त करने के लिए नहीं हो सकता है।

*The reciprocity date (if any) which has been allowed and the name of the country. Copyright in the design will subsist for ten years from the date of Registration, and may under the terms of the Act and Rules, be extended for a further period of five years. This Certificate is not for use in legal proceedings or for obtaining registration abroad.

(12) PATENT APPLICATION PUBLICATION

(21) Application No.202341038987 A

(19) INDIA

(22) Date of filing of Application :07/06/2023

(43) Publication Date : 08/09/2023

(54) Title of the invention : HESPERIDIN AND PHOSPHOLIPID 90 G LOADED TRANSFEROSOME FOR THE TREATMENT OF ANTI GOUT POTENTIAL

(51) International classification :A61P0019060000, C07H0017070000, A61K0008550000, A61K0047240000, A61K0009127000

(86) International Application No :NA
Filing Date :NA

(87) International Publication No : NA

(61) Patent of Addition to Application Number :NA
Filing Date :NA

(62) Divisional to Application Number :NA
Filing Date :NA

(71)Name of Applicant :

1)SUPRIYA CHIMAGAVE

Address of Applicant :KLE COLLEGE OF PHARMACY, JNMC CAMPUS, KAHER, NEHRU NAGAR, BELAGAVI. -----

2)SUNIL JALALPURE

3)AKSHAY K. PATIL

4)BHASKAR K. KURANGI

Name of Applicant : NA

Address of Applicant : NA

(72)Name of Inventor :

1)SUPRIYA CHIMAGAVE

Address of Applicant :KLE COLLEGE OF PHARMACY, JNMC CAMPUS, KAHER, NEHRU NAGAR, BELAGAVI. -----

(57) Abstract :

The transferal gel could be a good carrier for (he treatment of anti-gout potential Hesperia implemented via topical approach. The present innovation revealed improved Hesperia distributions via transferal gel form. PATENT OFFICE

No. of Pages : 20 No. of Claims : 6

(12) PATENT APPLICATION PUBLICATION

(21) Application No.202341007805 A

(19) INDIA

(22) Date of filing of Application :07/02/2023

(43) Publication Date : 17/02/2023

(54) Title of the invention : DEVELOPMENT OF CHRYSIN ENTRAPPED PHYTOSOMES FOR THE TREATMENT OF COLORECTAL CANCER

(51) International classification :A61P0035000000, A61K0036070000, H04W0036000000, A61J0007000000, B82Y0040000000

(86) International Application No :NA
Filing Date :NA

(87) International Publication No : NA

(61) Patent of Addition to Application Number :NA
Filing Date :NA

(62) Divisional to Application Number :NA
Filing Date :NA

(71)Name of Applicant :

1)Mr. NAMIT KUDATARKAR

Address of Applicant :DEPARTMENT OF PHARMACOLOGY, KLE COLLEGE OF PHARMACY, JNMC CAMPUS, KAHER, NEHRU NAGAR, BELAGAVI, KARNATAKA, INDIA, 590010. -----

2)Dr. SUNIL JALALPURE

3)Dr. BHASKAR KURANGI

Name of Applicant : NA

Address of Applicant : NA

(72)Name of Inventor :

1)Mr. NAMIT KUDATARKAR

Address of Applicant :DEPARTMENT OF PHARMACOLOGY, KLE COLLEGE OF PHARMACY, JNMC CAMPUS, KAHER, NEHRU NAGAR, BELAGAVI, KARNATAKA, INDIA, 590010. -----

2)Dr. SUNIL JALALPURE

Address of Applicant :DEPARTMENT OF

PHARMACOGNOSY, KLE COLLEGE OF PHARMACY, KAHER, NEHRU NAGAR, BELAGAVI, KARNATAKA, INDIA, 590010. -----

3)Dr. BHASKAR KURANGI

Address of Applicant :KLE COLLEGE OF PHARMACY, JNMC CAMPUS, KAHER, NEHRU NAGAR, BELAGAVI, KARNATAKA, INDIA, 590010. -----

(57) Abstract :

The Chrysin entrapped phytosomes could be considered as a promising carrier to target colorectal cancer when administered through oral route. The present invention demonstrated enhanced anticancer activity of chrysin entrapped phytosomes in the treatment of colorectal cancer.

No. of Pages : 14 No. of Claims : 3



Intellectual
Property
Office

Certificate of Registration for a UK Design

Design number: 6294311

Grant date: 13 July 2023

Registration date: 04 July 2023

This is to certify that,

in pursuance of and subject to the provision of Registered Designs Act 1949, the design of which a representation or specimen is attached, had been registered as of the date of registration shown above in the name of

Mr. Vrushabh Balaso Hupparage, Ms. Shailaja Ramesh Nare, Ms. Nikita Anand

Sadalage, Ms. Shweta Manjeet Rajput, Mr. Sujit Uttam Latawade, Mr. Ravindra

Jagannath Jarag, Mr. Avadhut Sidhgonda Athanikar, Mrs. Supriya Vrushabh

Hupparage

in respect of the application of such design to:

Coolant Liquid Assembly for Preservation of API

International Design Classification:

Version: 12-2019

Class: 15 MACHINES, NOT ELSEWHERE SPECIFIED

Subclass: 07 REFRIGERATION MACHINERY AND APPARATUS

Adam Williams

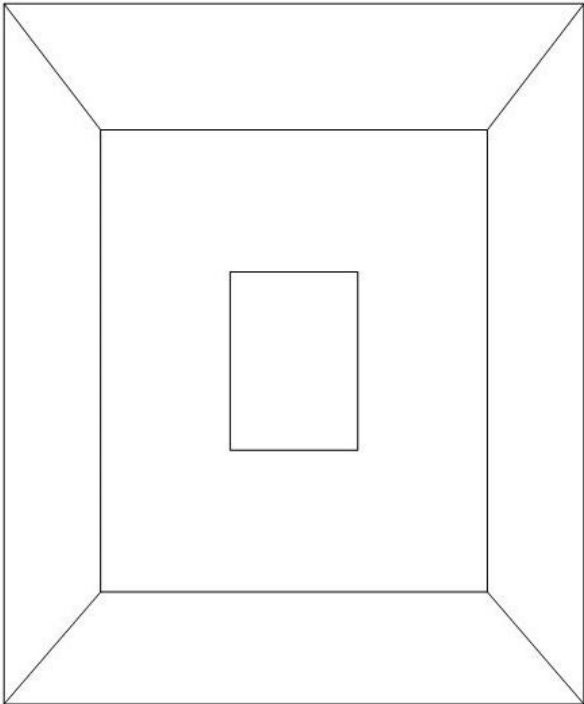
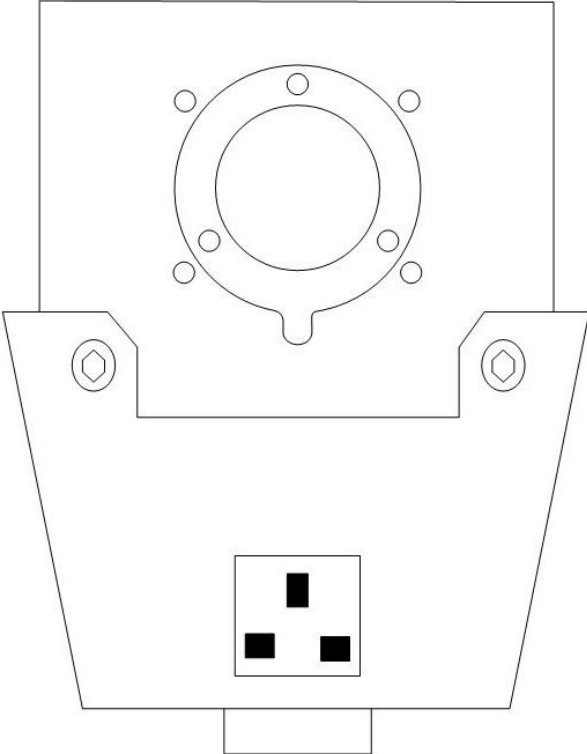
Comptroller-General of Patents, Designs and Trade Marks

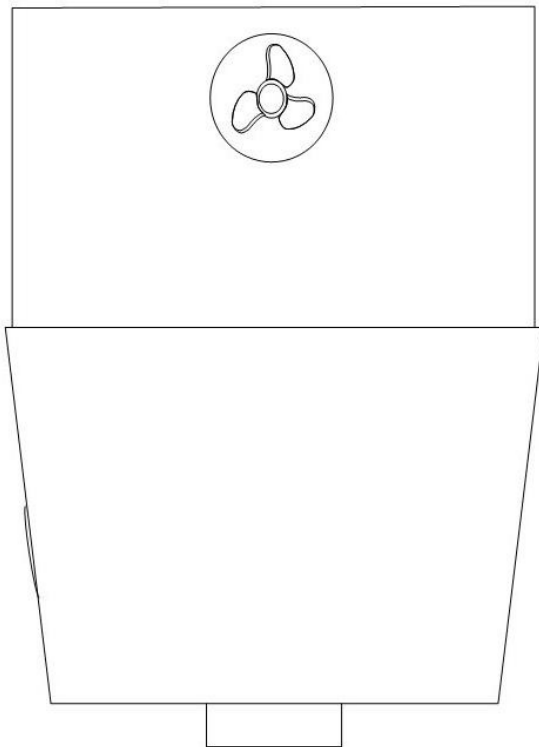
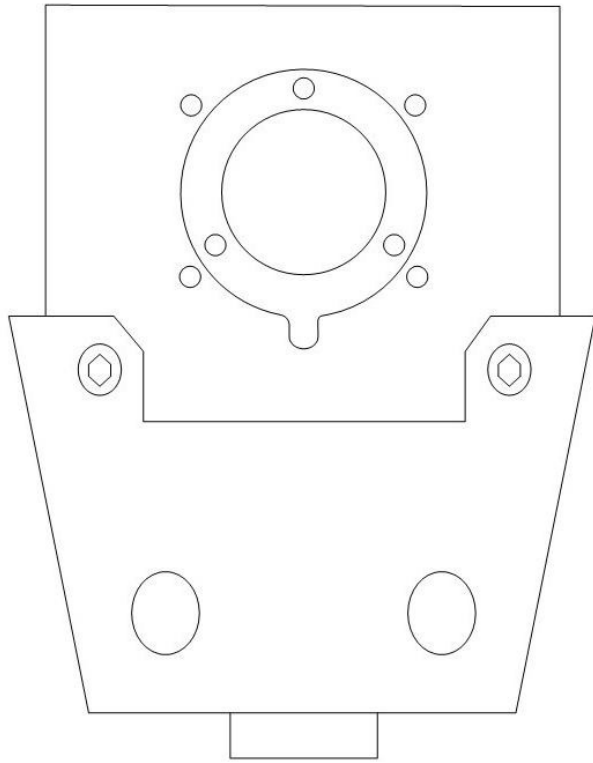
Intellectual Property Office

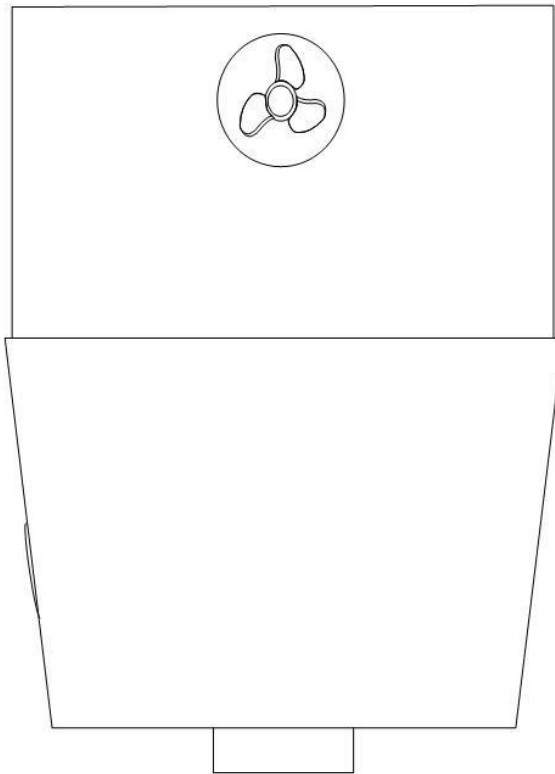
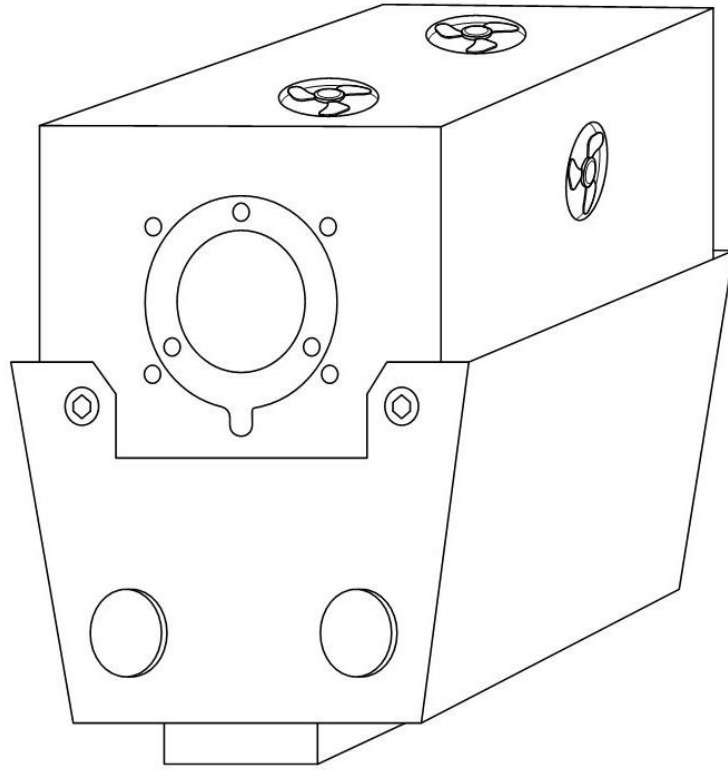
The attention of the Proprietor(s) is drawn to the important notes overleaf.

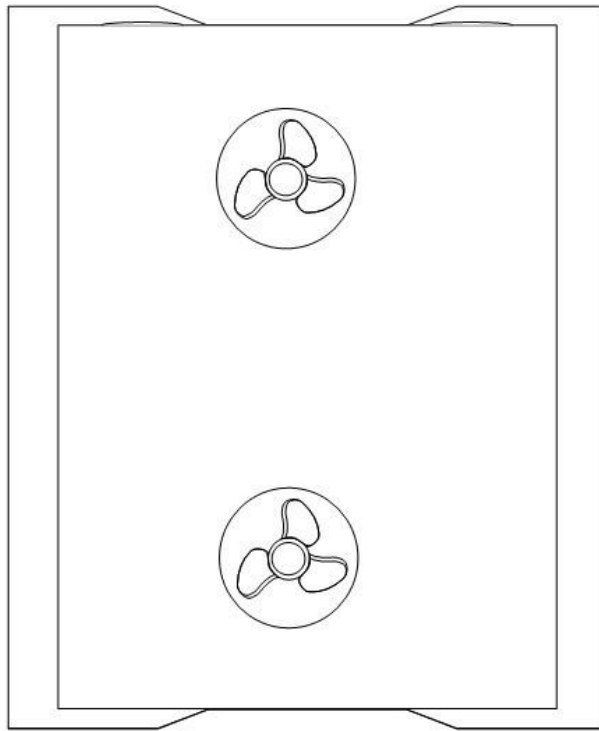


Representation of Designs









Intellectual Property Office is an operating name of the Patent Office

www.gov.uk/ipo

LIQUID COOLING ASSEMBLY FOR ACTIVE PHARMACEUTICAL INGREDIENT PRESERVATION

Liquid Cooling Assembly undergoes extensive flow network analysis using our proprietary design software powered by decades of empirical data. Meaning our thermal design engineers and system architects achieve a validated, on-specification thermal design much faster than anyone else on the market. We test each liquid cooling system to ensure expected performance and system behavior. Our flexible development model ranges from a heavy to light touch depending on your support needs. We adapt these liquid cooling systems for new applications in high performance industries, that need to transition to the high-capacity thermal performance of liquid systems.

Liquid Cooling Assembly, like coolant distribution units and recirculating chillers, incorporate detailed system intelligence to and from individual sensors, pumps, joints, and operating software for complete intelligent system behavior that maximizes sustainability and reliability. Efficiency is planned throughout the entire product lifecycle including packaging, installation fixtures, and quick service features that assure product integrity through shipping, maximize assembly throughput and minimize service time with hot-swappable quick disconnects.

High Reliability for Peak Performance with Sustainability in Mind

High reliability liquid cooling is applied at the system, enclosure, device, and component level with direct liquid cooling (DLC). Solutions range from complex liquid cooled server systems that integrate multiple technologies to cool the largest, most demanding hyperscale compute cloud data centers in the world to compact cold plates that bring liquid cooling performance direct to the silicon or power heat source with direct liquid cooling.

Increase performance efficiency, optimize energy use, maximize energy recovery, and increase reliability across all thermal system levels to minimize or remove waste, maintenance costs and downtime for a sustainable, lower total cost of cooling system ownership.

Raw materials, API and excipients can be sensitive to oxygen and moisture in the air. Therefore, they must often be protected with an inert gas to avoid unwelcome reactions, so that the active properties of the drug can be preserved. Inertization, protection and purification with nitrogen also contribute to reducing the risk of ignition and explosion when, for example, storing flammable solvents and milling powder.

Certain steps in the manufacture of API, such as chemical reactions at low temperatures, require low or very low temperatures. Liquid nitrogen can be used to cool the process, either directly or indirectly as it is vaporized and heated.

Freeze drying is often the process of choice for stabilizing therapeutic proteins or vaccines. Cryogenic freezing is an environmentally friendly alternative to conventional refrigerants (CFCs) in freeze drying, as the production cycle can be reduced.

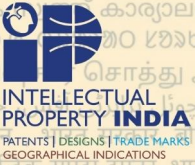
Logistics for the cold chain

Temperature variations can affect the stability of a medicine and thus its healing effect. Temperature-sensitive pharmaceutical and diagnostic products must be kept stable during distribution and arrive at their final destination without damage.

Packaging

Some medicines are sensitive to oxygen and moisture in the air. Therefore, they often have to be protected with an inert gas in order for them to maintain their healing effect. Some therapeutic proteins are packaged in a nitrogen atmosphere during fill-finish operations to extend shelf life.

As the gas comes into direct contact with the final pharmaceutical product, it is important that the gas supply is reliable and complies with current regulations.



ORIGINAL

क्रम सं/ Serial No. : 144297



पेटेंट कार्यालय, भारत सरकार

The Patent Office, Government Of India

डिजाइन के पंजीकरण का प्रमाण पत्र | Certificate of Registration of Design

डिजाइन सं. / Design No. : 390697-001

तारीख / Date : 20/07/2023

पारस्परिकता तारीख / Reciprocity Date* :

देश / Country

प्रमाणित किया जाता है कि संलग्न प्रति में वर्णित डिजाइन जो BIOSENSOR BASED DEVICE TO DETECT LUNG CANCER से संबंधित है, का पंजीकरण, श्रेणी 24-01 में 1.Dr. B. Lavanya 2. Dr. Priyanka Patil 3.Mr. Abhishek Sharma 4.Dr. Mangesh M Kumare 5.Ms. Harshita Singh 6.Mr. Alok Kumar Srivastava 7.Mrs. Moumita Dhara 8.Mrs. Jesima Begum Abdul Kathar के नाम में उपर्युक्त संख्या और तारीख में कर लिया गया है।

Certified that the design of which a copy is annexed hereto has been registered as of the number and date given above in class 24-01 in respect of the application of such design to BIOSENSOR BASED DEVICE TO DETECT LUNG CANCER in the name of 1.Dr. B. Lavanya 2. Dr. Priyanka Patil 3.Mr. Abhishek Sharma 4.Dr. Mangesh M Kumare 5.Ms. Harshita Singh 6.Mr. Alok Kumar Srivastava 7.Mrs. Moumita Dhara 8.Mrs. Jesima Begum Abdul Kathar.

डिजाइन अधिनियम, 2000 तथा डिजाइन नियम, 2001 के अधधीन प्रावधानों के अनुसरण में।

In pursuance of and subject to the provisions of the Designs Act, 2000 and the Designs Rules, 2001.

जारी करने की तिथि : 22/09/2023
Date of Issue



महानियंत्रक पेटेंट, डिजाइन और व्यापार चिह्न
Controller General of Patents, Designs and Trade Marks

*पारस्परिकता तारीख (यदि कोई हो) जिसकी अनुमति दी गई है तथा देश का नाम। डिजाइन का स्वत्वाधिकार पंजीकरण की तारीख से दस वर्षों के लिए होगा जिसका विस्तार, अधिनियम एवं नियम के निबंधनों के अधीन, पाँच वर्षों की अतिरिक्त अवधि के लिए किया जा सकेगा। इस प्रमाण पत्र का उपयोग विधिक कार्यवाहियों अथवा विदेश में पंजीकरण प्राप्त करने के लिए नहीं हो सकता है।
The reciprocity date (if any) which has been allowed and the name of the country. Copyright in the design will subsist for ten years from the date of Registration, and may under the terms of the Act and Rules, be extended for a further period of five years. This Certificate is not for use in legal proceedings or for obtaining registration abroad.

पेटेंट कार्यालय
शासकीय जर्नल

**OFFICIAL JOURNAL
OF
THE PATENT OFFICE**

निर्गमन सं. 06/2023
ISSUE NO. 06/2023

शुक्रवार
FRIDAY

दिनांक: 10/02/2023
DATE: 10/02/2023

पेटेंट कार्यालय का एक प्रकाशन
PUBLICATION OF THE PATENT OFFICE

(12) PATENT APPLICATION PUBLICATION

(21) Application No.202311006681 A

(19) INDIA

(22) Date of filing of Application :02/02/2023

(43) Publication Date : 10/02/2023

(54) Title of the invention : PROCESS FOR SYNTHESIS 1,2,4-TRIAZOLE DERIVATIVES WITH ANTICANCER ACTIVITY

<p>(51) International classification :A61P0035000000, C07D0409040000, A61P0035020000, G01N0033500000, C07D0249140000</p> <p>(86) International Application No :NA Filing Date :NA</p> <p>(87) International Publication No : NA</p> <p>(61) Patent of Addition to Application Number :NA Filing Date :NA</p> <p>(62) Divisional to Application Number :NA Filing Date :NA</p>	<p>(71)Name of Applicant : 1)ANURAG MISHRA Address of Applicant :NIMS UNIVERSITY RAJASTHAN JAIPUR ----- ----- 2)MR MOHIT AGARWAL 3)ROHINI S. KAVALAPURE 4)SUSHAMA RAWAT 5)DR PANKAJ MISHRA 6)PANKAJ KUMAR SHANKHDAR 7)SONU JANGIR 8)DR SHAMBADITYA GOSWAMI 9)DEEPAK MEHER. 10)S. HARI HARA SUDHAN 11)ROSHNI SINGH Name of Applicant : NA Address of Applicant : NA</p> <p>(72)Name of Inventor : 1)MR MOHIT AGARWAL Address of Applicant :Associate Professor, NIMS Institute of Pharmacy, NIMS University Rajasthan Jaipur-303121 ----- ----- 2)ROHINI S. KAVALAPURE Address of Applicant :Assistant professor, Department of Pharmaceutical Chemistry, KLE College of pharmacy, Belagavi, KLE Academy of Higher Education and Research, Belagavi ,Karnataka, India ----- ----- 3)SUSHAMA RAWAT Address of Applicant :Jaipur National University, SADTM campus, Jagatpura-302017 ----- ----- 4)DR PANKAJ MISHRA Address of Applicant :Principal, Keshlata college of Pharmacy, Campus Keshlata Hospital, Delapeer, Bareilly U.P. pincode 243122. ----- ----- 5)PANKAJ KUMAR SHANKHDAR Address of Applicant :Associate Professor BIU College of Pharmacy, Bareilly International University, Rohilkhand Medical College Campus, Pilibhit Bypass Road Bareilly ----- ----- 6)SONU JANGIR Address of Applicant :Rama & Krishna college of Pharmacy, Maksuspur, Narnaul, Haryana-123001 ----- ----- 7)DR SHAMBADITYA GOSWAMI Address of Applicant :DIVINE COLLEGE OF PHARMACY SIWAN, BIHAR 841245 ----- ----- 8)DEEPAK MEHER. Address of Applicant :VIJAY PHARMACY COLLEGE PINCODE- Gulalpur,JAUNPUR-222139 (UP) ----- ----- 9)S. HARI HARA SUDHAN Address of Applicant :Department of Pharmaceutics, Raghavendra Institute of pharmaceutical education and Research-autonomous, Anantapuramu, Andhra Pradesh-515001 ----- ----- 10)ROSHNI SINGH Address of Applicant :NIMS Institute of Pharmacy, NIMS University Rajasthan Jaipur-303121 ----- -----</p>
---	---

(57) Abstract :

The present invention pertains to a process for synthesis 1,2,4-triazole derivatives with anticancer activity. Nineteen new 1,2,4-triazole derivatives were synthesized and are described. Using the MTT test, the cytotoxic properties of the synthesized compounds were assessed against the MCF-7, Hela, and A549 cell lines, three human cancer cell lines. The cytotoxic activity of compounds 7d, 7e, 10a, and 10d against the Hela cell line was promising and was lower than 12 M. It was reassuring to see that the majority of the produced compounds exhibit appropriate selectivity against normal and cytotoxic malignant cell lines when the safety of these compounds was also assessed on MRC-5, a normal cell line. The present research may open the path for the creation of new anticancer drugs with excellent effectiveness and fewer side effects, such as 1, 2, 4-triazole-pyridine.

No. of Pages : 12 No. of Claims : 5

पेटेंट कार्यालय
शासकीय जर्नल

**OFFICIAL JOURNAL
OF
THE PATENT OFFICE**

निर्गमन सं. 35/2023
ISSUE NO. 35/2023

शुक्रवार
FRIDAY

दिनांक: 01/09/2023
DATE: 01/09/2023

पेटेंट कार्यालय का एक प्रकाशन
PUBLICATION OF THE PATENT OFFICE

(54) Title of the invention : BIOANALYTICAL METHOD DEVELOPMENT AND VALIDATION OF ANTIDIABETIC DRUG BY USING HIGH-PERFORMANCE LIQUID CHROMATOGRAPHY (HPLC)

(51) International classification :G01N0030020000, G01N0033940000, G01N0033680000, G01N0030860000,
 (86) International Application No :PCT//
 Filing Date :01/01/1900
 (87) International Publication No : NA
 (61) Patent of Addition to Application Number :NA
 Filing Date :NA
 (62) Divisional to Application Number :NA
 Filing Date :NA

(71)Name of Applicant :
1)Dr. Ampati Srinivas
 Address of Applicant :Professor, Unity College of Pharmacy, Raigir (v), Bhongir (M)Yadadri Bhuvanagiri(Dist), Telangana-508116 Yadadri Bhuvanagiri -----
2)Gennepally Sahithi Reddy
3)Banda Mahesh
4)Ms. Mayuri Diliprao Gawande
5)Richa Shakya
6)Sonia Chauhan
7)Sakshi Sharma
8)Dr. Basavaraj Mrutyunjay Dinnimath
9)Dr. Rakesh Kumar Gupta
10)Dr. Amandeep Singh
11)Dr. Vikesh Kumar Shukla
12)Dr. Rajagopalan Ramanathan
 Name of Applicant : NA
 Address of Applicant : NA
 (72)Name of Inventor :
1)Dr. Ampati Srinivas
 Address of Applicant :Professor, Unity College of Pharmacy, Raigir (v), Bhongir (M)Yadadri Bhuvanagiri(Dist), Telangana-508116 Yadadri Bhuvanagiri -----
2)Gennepally Sahithi Reddy
 Address of Applicant :Assistant Professor, Unity College of Pharmacy, Raigir (v), Bhongir (M), Yadadri Bhuvanagiri(Dist), Telangana -508116, India Yadadri Bhuvanagiri -----
3)Banda Mahesh
 Address of Applicant :Assistant Professor, Unity College of Pharmacy, Raigir (v), Bhongir (M), Yadadri Bhuvanagiri(Dist), Telangana- 508116, India Yadadri Bhuvanagiri -----
4)Ms. Mayuri Diliprao Gawande
 Address of Applicant :S.G.S.P.S. Institute Of Pharmacy Kaulked Akola, Maharashtra- 444004, India Akola -----
5)Richa Shakya
 Address of Applicant :Assistant Professor, Noida Institute of Engineering and Technology (Pharmacy Institute), Greater Noida, Uttar Pradesh-201306, India Gautam Buddha Nagar -----
6)Sonia Chauhan
 Address of Applicant :Assistant professor, Noida Institute of Engineering and Technology (Pharmacy Institute), Greater Noida, Uttar Pradesh-201306, India Gautam Buddha Nagar -----
7)Sakshi Sharma
 Address of Applicant :Assistant Professor, Noida Institute of Engineering and Technology (Pharmacy Institute), Greater Noida, Uttar Pradesh-201306, India Gautam Buddha Nagar -----
8)Dr. Basavaraj Mrutyunjay Dinnimath
 Address of Applicant :Associate Professor, KLE College of Pharmacy, Belagavi, Karnataka- 590010, India Belgaum -----
9)Dr. Rakesh Kumar Gupta
 Address of Applicant :Professor, Jaipur college of pharmacy, ISI-15 Riico Institutional area sitapura , Jaipur, Rajasthan – 302022, India Jaipur -----
10)Dr. Amandeep Singh
 Address of Applicant :Professor and Head, School of Pharmacy and Research, Dev Bhoomi Uttarakhand University, Dehradun, Uttarakhand- 248007, India Dehradun -----
11)Dr. Vikesh Kumar Shukla
 Address of Applicant :Amity Institute of Pharmacy, Amity university, Sector 125, Noida, Uttar Pradesh- 20130, India Gautam Buddha Nagar -----
12)Dr. Rajagopalan Ramanathan
 Address of Applicant :Associate Professor, Department of Pharmaceutics, Periyar College of Pharmaceutical Sciences, Periyar Centenary Educational Complex, Sathanur Main Road, Tiruchirappalli, Tamil Nadu-620 021, India Tiruchirappalli -----

(57) Abstract :

This present invention provides a robust bioanalytical method development and validation process for accurate quantification of antidiabetic drugs using High-Performance Liquid Chromatography (HPLC). The method involves a systematic approach, starting with the collection and careful preparation of biological samples from diabetic patients undergoing antidiabetic drug treatment. The HPLC system is equipped with a well-optimized chromatographic column, mobile phase, and detector to achieve efficient separation and high sensitivity. Calibration standards with known drug concentrations are used to construct a calibration curve, facilitating precise drug quantification. The biological samples and calibration standards are sequentially injected into the HPLC system, and drug compounds are separated based on their unique physicochemical properties. The detector quantifies drug concentrations, and data analysis generates the calibration curve by plotting peak area or height against known concentrations.

No. of Pages : 15 No. of Claims : 10

(54) Title of the invention : UTILIZATION OF BIOLOGICAL WASTE FROM DRAGON FRUITS IN DEVELOPMENT OF SILVER NANOPARTICLES FOR POTENTIAL ANTICANCER ACTIVITY”

<p>(51) International classification :A61P0035000000, A61K0033380000, A61K0036330000, G16B0005000000, G16C0020500000</p> <p>(86) International Application No :PCT// Filing Date :01/01/1900</p> <p>(87) International Publication No : NA</p> <p>(61) Patent of Addition to Application Number :NA Filing Date :NA</p> <p>(62) Divisional to Application Number :NA Filing Date :NA</p>	<p>(71)Name of Applicant :</p> <p>1)Dr. Preeti Salve Address of Applicant :Department of Pharmaceutical Chemistry, KLE College of Pharmacy, Nehru Nagar, Belagavi-590010, Karnataka, India. -----</p> <p>2)Ms. G. Kushala Reddy 3)Ms. Sukanya S. Pote 4)Mr. Prathamesh V. Magadum 5)Mr. Sourabh S. Malabade 6)Mr. Shreyansh S. Khurpe</p> <p>Name of Applicant : NA Address of Applicant : NA</p> <p>(72)Name of Inventor :</p> <p>1)Dr. Preeti Salve Address of Applicant :Department of Pharmaceutical Chemistry, KLE College of Pharmacy, Nehru Nagar, Belagavi-590010, Karnataka, India. -----</p> <p>2)Ms. G. Kushala Reddy Address of Applicant :KLE College of Pharmacy, Nehru Nagar, Belagavi-590010, Karnataka, India -----</p> <p>3)Ms. Sukanya S. Pote Address of Applicant :KLE College of Pharmacy, Nehru Nagar, Belagavi-590010, Karnataka, India -----</p> <p>4)Mr. Prathamesh V. Magadum Address of Applicant :KLE College of Pharmacy, Nehru Nagar, Belagavi-590010, Karnataka, India. -----</p> <p>5)Mr. Sourabh S. Malabade Address of Applicant :KLE College of Pharmacy, Nehru Nagar, Belagavi-590010, Karnataka, India -----</p> <p>6)Mr. Shreyansh S. Khurpe Address of Applicant :KLE College of Pharmacy, Nehru Nagar, Belagavi-590010, Karnataka, India -----</p>
--	---

(57) Abstract :

The present invention relates to synthesis of silver nanoparticles (AgNPs) using *Hylocereus undatus* (H. undatus) fruit peel and water is used as solvent for extraction. The characterization of synthesized nanoparticles is performed by microscopic and spectroscopic methods. Further invention relates to cytotoxicity studies which are performed using L929 cell lines (mouse fibroblast cell lines), while in-vitro anticancer activity is performed against HeLa (cervical cancer) as well as MDA MB 231(breast cancer) cell lines. In addition, in-silico studies are done which included network pharmacology and molecular docking using EGFR (PDB ID: IM17) as the target.

No. of Pages : 16 No. of Claims : 4



Intellectual
Property
Office

Certificate of Registration for a UK Design

Design number: 6298494

Grant date: 01 August 2023

Registration date: 22 July 2023

This is to certify that,

in pursuance of and subject to the provision of Registered Designs Act 1949, the design of which a representation or specimen is attached, had been registered as of the date of registration shown above in the name of

Dr. Hareesh Dara, Mrs. Varsha Jain Bellur Adirajaiah, Dr. Gaurav Bhaduka, Dr

Sadhu Nelson Kumar, Dr. Basavaraj Mrutyunjay Dinnimath, Mr. Hitesh Kumar,

Anupma Yadav, Dr. Satisha Hegde, Anuradha Yadav, Dr Valluri Asha Ranjani,

Amar Kumar Maheshbhai Raval, Dr. Ojash Bhogilal Patel

in respect of the application of such design to:

HIGH SPEED COMPACT CENTRIFUGE USED IN BIOTEHNOLOGY

LABORATORY

International Design Classification:

Version: 14-2023

Class: 24 MEDICAL AND LABORATORY EQUIPMENT

Subclass: 01 APPARATUS AND EQUIPMENT FOR DOCTORS, HOSPITALS
AND LABORATORIES

Adam Williams

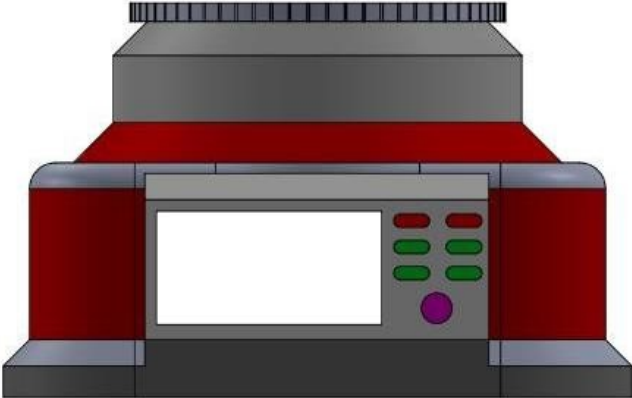
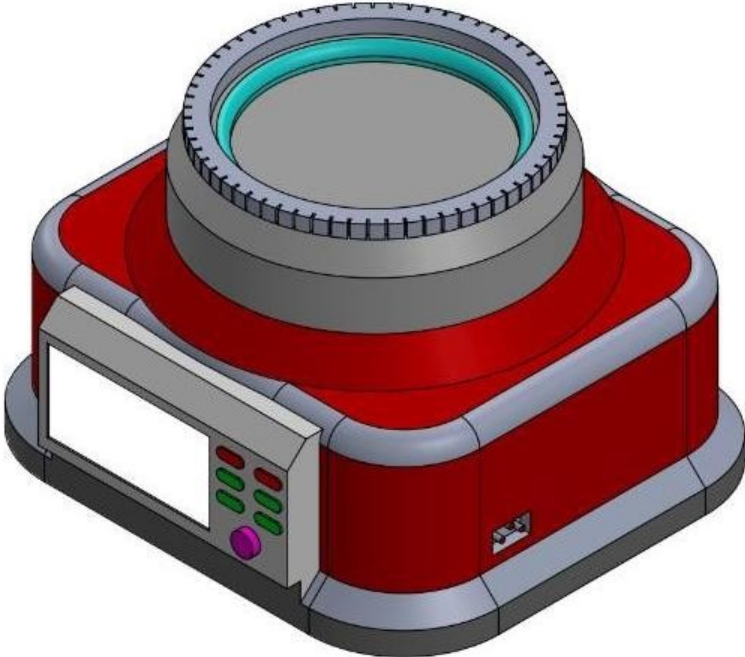
Comptroller-General of Patents, Designs and Trade Marks

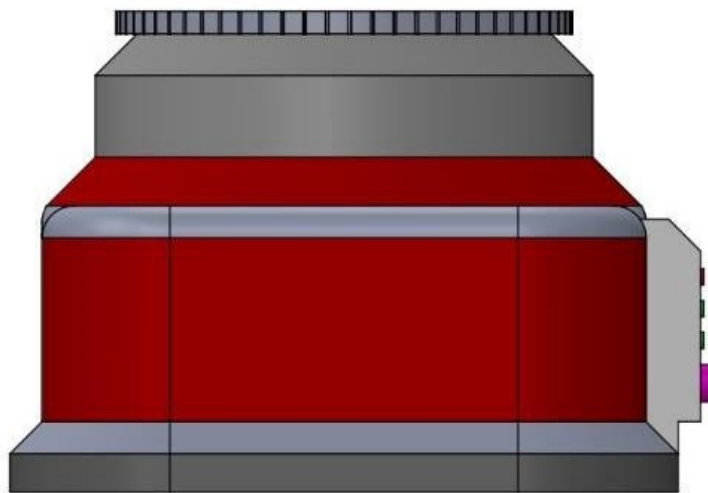
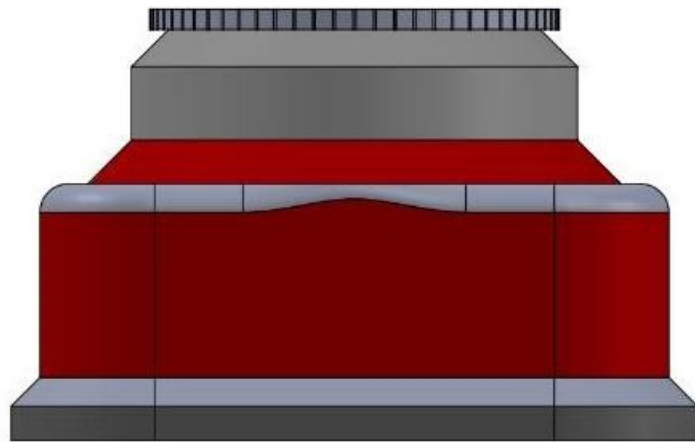
Intellectual Property Office

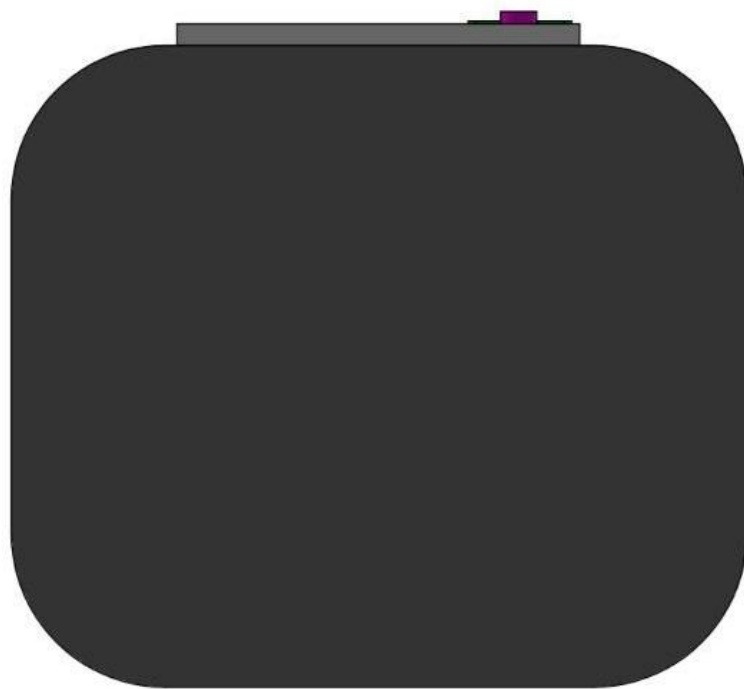
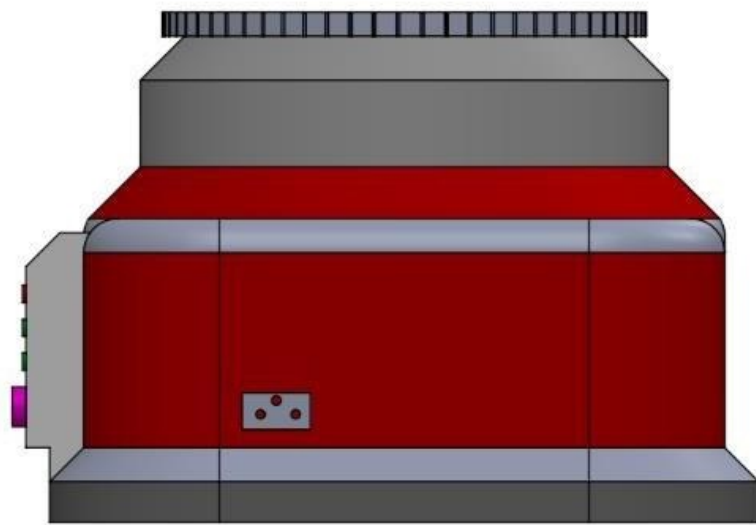
The attention of the Proprietor(s) is drawn to the important notes overleaf.

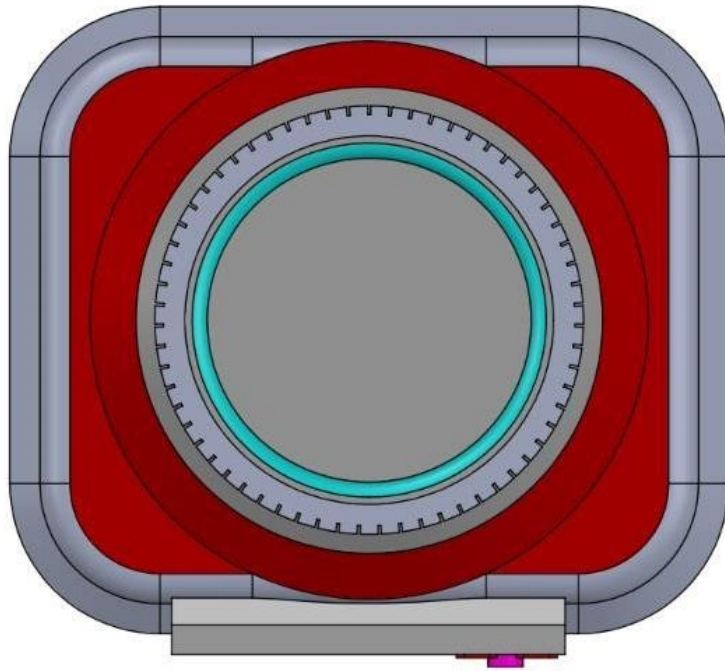


Representation of Designs









Intellectual Property Office is an operating name of the Patent Office

www.gov.uk/ipo

Federal Republic of Germany

Certificate

About the registration of the utility model No. 20 2022 106 990

Designation:

A nanosponge for targeted and controlled drug delivery

IPC:

A61K 9/19

Inhaber/Inhaberin:

Atchutuni, Venkata Subrahmanyeswara Ravi Sai Nadh, Vijayawada,
IN Eldeeb, Sarni, 38104 Braunschweig, DE
Konda, Ravi Kumar, Guntur, IN
Kumaraswamy, Gandia, Hanamk nda, IN
Mohanradj, Dhanalakshmi, Pondycherry, IN
Pathange, Bharghava Bhushan Rao, Vijayawada, IN
Sidagouda Patil, Archana, Belagavi, IN

Day of registration:

14.12.2022

Date of registration:

11.01.2023

The President of the German Patent and Trade Mark Office



Cornelia Rudloff-Schaffer

MO nchen, 11.01.2023



The requirements for protection are **not** examined when registering a utility model. For the current legal status and scope of protection, please refer to the DPMAregister at www.dpma.de.



ORIGINAL

मूल/No : 130193



भारत सरकार
GOVERNMENT OF INDIA
पेटेंट कार्यालय
THE PATENT OFFICE

डिजाइन के पंजीकरण का प्रमाणपत्र
CERTIFICATE OF REGISTRATION OF DESIGN

डिजाइन सं. / Design No. : 374542-001
तारीख / Date : 23/11/2022
पारस्परिकता तारीख / Reciprocity Date* :
देश / Country :

प्रमाणित किया जाता है कि संलग्न प्रति में वर्णित डिजाइन जो **FLUID TRANSFER APPARATUS FOR MEDICAL PURPOSE** से संबंधित है, का पंजीकरण, श्रेणी **24-01** में 1.Repudi Lalitha 2. **Dr. Archana S. Patil** 3.**Dr Pathange Bharghava Bhushan Rao** 4.**Manish Kumar Maity** के नाम में उपर्युक्त संख्या और तारीख में कर लिया गया है।

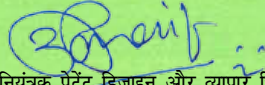
Certified that the design of which a copy is annexed hereto has been registered as of the number and date given above in class **24-01** in respect of the application of such design to **FLUID TRANSFER APPARATUS FOR MEDICAL PURPOSE** in the name of 1.Repudi Lalitha 2. Dr. Archana S. Patil 3.**Dr Pathange Bharghava Bhushan Rao** 4.**Manish Kumar Maity**.

डिजाइन अधिनियम, 2000 तथा डिजाइन नियम, 2001 के अध्याधीन प्रावधानों के अनुसरण में।

In pursuance of and subject to the provisions of the Designs Act, 2000 and the Designs Rules, 2001.

INTELLECTUAL
PROPERTY INDIA
PATENTS | DESIGNS | TRADE MARKS
GEOGRAPHICAL INDICATIONS

निर्गमन की तारीख/Date of Issue : 03/03/2023


महानियंत्रक पेटेंट डिजाइन और व्यापार चिह्न
Controller General of Patents, Designs and Trade Marks

पारस्परिकता तारीख (यदि कोई हो) जिसकी अनुमति देश के नाम पर की गई है। डिजाइन का सत्त्वाधिकार पंजीकरण की तारीख से दस वर्षों के लिए होगा जिसका विस्तार, अधिनियम एवं नियम के निबंधनों के अधीन, पाँच वर्षों की अतिरिक्त अवधि के लिए किया जा सकेगा। इस प्रमाण पत्र का उपयोग विधिक कार्यवाहियों अथवा विदेश में पंजीकरण प्राप्त करने के लिए नहीं हो सकता है।

*The reciprocity date (if any) which has been allowed and the name of the country. Copyright in the design will subsist for ten years from the date of Registration, and may under the terms of the Act and Rules, be extended for a further period of five years. This Certificate is not for use in legal proceedings or for obtaining registration abroad.



**INTELLECTUAL
PROPERTY INDIA**
PATENTS | DESIGNS | TRADE MARKS
GEOGRAPHICAL INDICATIONS



सत्यमेव जयते

क्रमांक : 044153332
SL No :



भारत सरकार
GOVERNMENT OF INDIA
पेटेंट कार्यालय
THE PATENT OFFICE
पेटेंट प्रमाणपत्र
PATENT CERTIFICATE
(Rule 74 of The Patents Rules)

पेटेंट सं. / Patent No. : 431185
आवेदन सं. / Application No. : 202241054958
फाइल करने की तारीख / Date of Filing : 26/09/2022
पेटेंटी / Patentee : 1.DR. BHASKAR KURANGI 2.MR. MOAZZIM SOUDAGAR
3.MR. CHETHAN KUMAR H B 4.DR. SUNEEL DODAMANI
et al.

प्रमाणित किया जाता है कि पेटेंटी को, उपरोक्त आवेदन में यथाप्रकटित DEVELOPMENT OF BERBERINE LOADED CUBOSOMAL NANOFORMULATION FOR THE TOPICAL TREATMENT OF ACNE नामक आविष्कार के लिए, पेटेंट अधिनियम, 1970 के उपबंधों के अनुसार आज तारीख सितम्बर 2022 के छब्बीसवें दिन से बीस वर्ष की अवधि के लिए पेटेंट अनुदत्त किया गया है।

It is hereby certified that a patent has been granted to the patentee for an invention entitled DEVELOPMENT OF BERBERINE LOADED CUBOSOMAL NANOFORMULATION FOR THE TOPICAL TREATMENT OF ACNE as disclosed in the above mentioned application for the term of 20 years from the 26th day of September 2022 in accordance with the provisions of the Patents Act,1970.

INTELLECTUAL
PROPERTY INDIA
PATENTS | DESIGNS | TRADE MARKS
GEOGRAPHICAL INDICATIONS



अनुदान की तारीख : 08/05/2023
Date of Grant :

पेटेंट नियंत्रक
Controller of Patent

टिप्पणी - इस पेटेंट के नवीकरण के लिए फीस, यदि इसे बनाए रखा जाना है, सितम्बर 2024 के छब्बीसवें दिन को और उसके पश्चात प्रत्येक वर्ष में उसी दिन देय होगी।

Note. - The fees for renewal of this patent, if it is to be maintained will fall / has fallen due on 26th day of September 2024 and on the same day in every year thereafter.

(12) PATENT APPLICATION PUBLICATION

(19) INDIA

(22) Date of filing of Application :29/07/2023

(21) Application No.202341051109 A

(43) Publication Date : 01/09/2023

(54) Title of the invention : "FORMULATION, EVALUATION AND OPTIMIZATION OF TACROLIMUS LOADED TRANSETHOSOMES FOR THE MANAGEMENT OF PSORIASIS"

<p>(51) International classification :A61P0017060000, A61K0009000000, A61K0047320000, A61P0017000000, G16H0010600000</p> <p>(86) International Application No :PCT// Filing Date :01/01/1900</p> <p>(87) International Publication No : NA</p> <p>(61) Patent of Addition to Application Number :NA Filing Date :NA</p> <p>(62) Divisional to Application Number :NA Filing Date :NA</p>	<p>(71)Name of Applicant :</p> <p>1)Mrs. Kishori P. Sutar Address of Applicant :Asst. Professor, Department of Pharmaceutics, KLE College of Pharmacy Belagavi.KLE Academy of Higher Education and Research, Belagavi-590010, Karnataka, India. -----</p> <p>2)Mr. Vishwanath A. Jadhav</p> <p>3)Dr. Manasa Kulkarni</p> <p>4)Mr. Sourabh Shrikant Hande Name of Applicant : NA Address of Applicant : NA</p> <p>(72)Name of Inventor :</p> <p>1)Mrs. Kishori P. Sutar Address of Applicant :Asst. Professor, Department of Pharmaceutics, KLE College of Pharmacy Belagavi.KLE Academy of Higher Education and Research, Belagavi-590010, Karnataka, India. -----</p> <p>2)Mr. Vishwanath A. Jadhav Address of Applicant :Post Graduate Student, Department of Pharmaceutics, KLE College of Pharmacy Belagavi, KLE Academy of Higher Education and Research, Belagavi-590010, Karnataka, India -----</p> <p>3)Dr. Manasa Kulkarni Address of Applicant :Physiotherapist Diyaa Hospital, Chikodi-591201, Kamataka, India. -----</p> <p>4)Mr. Sourabh Shrikant Hande Address of Applicant :Post Graduate Student, Department of Pharmacology, KLE College of Pharmacy Belagavi, KLE Academy of Higher Education and Research, Belagavi-590010, Karnataka, India. -----</p>
--	--

(57) Abstract

पेटेंट कार्यालय का एक प्रकाशन
PUBLICATION OF THE PATENT OFFICE

The Patent Office Journal No. 35/2023 Dated 01/09/2023

55876

(12) PATENT APPLICATION PUBLICATION

(21) Application No.202341044114 A

(19) INDIA

(22) Date of filing of Application :30/06/2023

(43) Publication Date : 01/09/2023

(54) Title of the invention : "BUCCAL FILMS OF LORNOXICAM CO-CRYSTALS"

(51) International classification :A61P0043000000, A61K0031542000, A61K0009000000, A61P0009100000, A61P0015100000

(86) International Application No :PCT//
Filing Date :01/01/1900

(87) International Publication No : NA

(61) Patent of Addition to Application Number :NA
Filing Date :NA

(62) Divisional to Application Number :NA
Filing Date :NA

(71)Name of Applicant :

1)Dr. Vijaya G.Joshi

Address of Applicant :Professor, HOD, Department of Pharmaceutics, Government College of Pharmacy, Bengaluru. 560 027. Karnataka, India. -----

2)Mr. Vinay Kumar C

3)Mrs. Kishori P.Sutar

Name of Applicant : NA

Address of Applicant : NA

(72)Name of Inventor :

1)Dr. Vijaya G.Joshi

Address of Applicant :Professor, HOD, Department of Pharmaceutics, Government College of Pharmacy, Bengaluru. 560 027. Karnataka, India. -----

2)Mr. Vinay Kumar C

Address of Applicant :Post Graduate in Department of Pharmaceutics, Government College of Pharmacy, Bengaluru. Karnataka, India. -----

3)Mrs. Kishori P.Sutar

Address of Applicant :Asst. Professor, Department of Pharmaceutics, KLE College of Pharmacy, KLE Academy of Higher Education and Research, Belagavi-590010, Karnataka, India. -----

पेटेंट कार्यालय का एक प्रकाशन
PUBLICATION OF THE PATENT OFFICE

The Patent Office Journal No. 35/2023 Dated 01/09/2023

55876

(12) PATENT APPLICATION PUBLICATION

(21) Application No.202341046428 A

(19) INDIA

(22) Date of filing of Application :10/07/2023

(43) Publication Date : 01/09/2023

(54) Title of the invention : "BERBERINE NANOETHOSOMAL VAGINAL IN-SITU GEL FOR POLYCYSTIC OVARY SYNDROME"

(51) International classification :A61K0031437500, A61K0031155000, A61K0009000000, A61K0031567000, A61K0009060000
(86) International Application No :PCT//
Filing Date :01/01/1900
(87) International Publication No : NA
(61) Patent of Addition to Application Number :NA
Filing Date :NA
(62) Divisional to Application Number :NA
Filing Date :NA

(71)Name of Applicant :

1)Mrs. Kishori P. Sutar

Address of Applicant :Asst. Professor, Department of Pharmaceutics, KLE Collegeof Pharmacy Belagavi, KLE Academy of Higher Education and Research, Belagavi-590010, Karnataka, India. -----

2)Mr. Siddarth Usulkar

3)Mr. Prakash Biradar

4)Mr. Swapnil Patil

5)Ms. Rachana Pockle

Name of Applicant : NA

Address of Applicant : NA

(72)Name of Inventor :

1)Mrs. Kishori P. Sutar

Address of Applicant :Asst. Professor, Department of Pharmaceutics, KLE Collegeof Pharmacy Belagavi, KLE Academy of Higher Education and Research, Belagavi-590010, Karnataka, India. -----

2)Mr. Siddarth Usulkar

Address of Applicant :Post Graduate Student, Department of Pharmaceutics, KLE College of Pharmacy Belagavi, KLE Academy of Higher Education and Research, Belagavi-590010, Karnataka, India. -----

3)Mr. Prakash Biradar

Address of Applicant :Asst. Professor, Department of Pharmacology, KLE Collegeof Pharmacy Belagavi, KLE Academy of Higher Education and Research, Belagavi-590010, Karnataka, India. -----

4)Mr. Swapnil Patil

Address of Applicant :Post Graduate Student, Department of Pharmaceutics, KLE Collegeof Pharmacy Belagavi, KLE Academy of Higher Education and Research, Belagavi-590010, Karnataka, India -----

5)Ms. Rachana Pockle

Address of Applicant :Post Graduate Student, Department of Pharmaceutics, KLE Collegeof Pharmacy Belagavi, KLE Academy of Higher Education and Research, Belagavi-590010, Karnataka, India -----

INTRODUCTION

In view of the recent amendment made in the Designs (Amendment) Rules, 2008 with effect from 17/06/2008, Publication of the matter relating to Designs is being published in the Official Journal of The Patent Office. This Journal is being published on weekly basis on every Friday covering the various proceedings on Designs as required according to the provisions of under Rule 22, 25, 27 and 39 of the Design (Amendment) Rules, 2008. All the enquiries on this Official Journal and other information as required by the public should be addressed to the Controller General of Patents, Designs & Trade Marks. Suggestions and comments are requested from all quarters so that the content can be enriched.

CANCELLATION PROCEEDINGS
Under Section 19 of the Designs Act, 2000 &
under Rule 29(1) of Designs Rules, 2001 (As Amended)

DECISION

The Joint Controller of Patents & Designs by his order dated 08/08/2023 dismissed the petition, filed by KALPESH MANUBHAI RAMOLIYA having principal place of business at Survey no.31, Plot No.58, B/H Hotel Krishna Park, Near Falcon Pumps Pvt.Ltd, Gondal Road, Vavdi-Rajkot, Gujarat, for cancellation of the registration of **registered Design No.324986-016** dated 24/12/2019 under class 23-04 titled as 'GRILL FOR AIR COOLER' in the name of MITA ASHOK KAPOOR, an Indian national 1, Scenic Acres, Vapi ChalaRoad, Vapi-396191, Gujarat, India.

DECISION

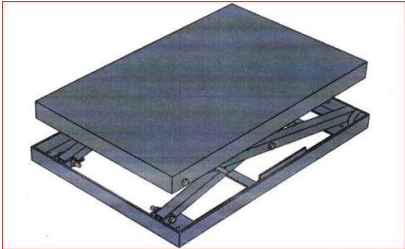
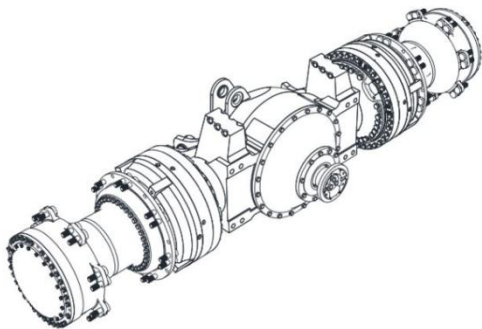

The Joint Controller of Patents & Designs by his order dated 08/08/2023 dismissed the petition, filed by KALPESH MANUBHAI RAMOLIYA having principal place of business at Survey no.31, Plot No.58, B/H Hotel Krishna Park, Near Falcon Pumps Pvt.Ltd, Gondal Road, Vavdi-Rajkot, Gujarat, for cancellation of the registration of **registered Design No.324986-017** dated 24/12/2019 under class 23-04 titled as 'GRILL FOR AIR COOLER' in the name of MITA ASHOK KAPOOR, an Indian national 1, Scenic Acres, Vapi ChalaRoad, Vapi-396191, Gujarat, India.

COPYRIGHT PUBLICATION

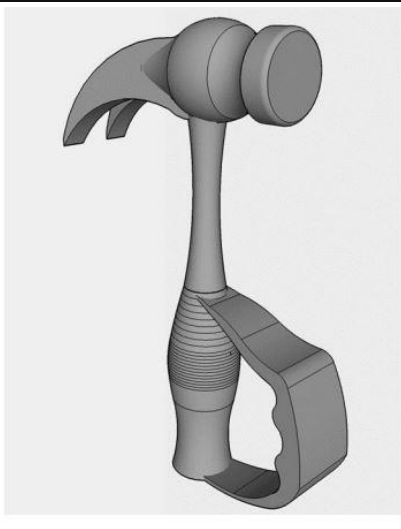
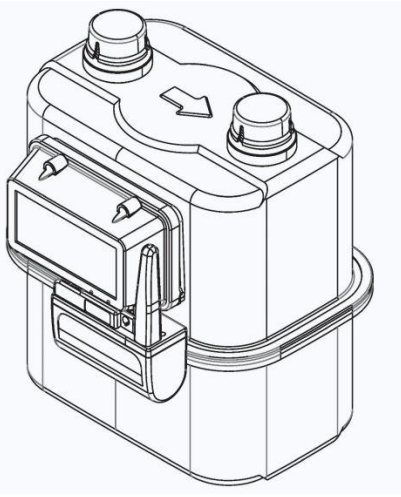

Sr No	REGISTERED DESIGN NUMBERS	RENEWED ON
1	256120	22-08-2023
2	256122	22-08-2023
3	256121	22-08-2023
4	258021	22-08-2023
5	256900	22-08-2023
6	257800	22-08-2023
7	246599	24-08-2023
8	243757	24-08-2023
9	243755	24-08-2023
10	243756	24-08-2023
11	242382	24-08-2023
12	256066	24-08-2023

REGISTRATION OF DESIGNS

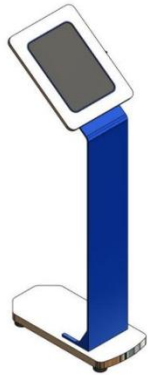
The following designs have been registered. They are now open for public inspection. In the following each entry the Date of Registration is shown. The Priority Number, Priority Date and Priority Country are also shown


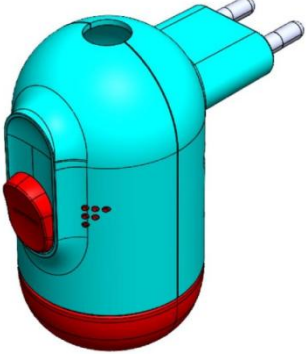
Design Number	384964-001	
Class	12-05	
1. Marwadi University Rajkot – Morbi Highway Road, Gauridad, Rajkot, Gujarat 360003 2. Prof. (Dr) Bhavesh K. Kanabar Department of Mechanical Engineering, Marwadi University, Rajkot – Morbi Highway Road, Gauridad, Rajkot, Gujarat 3. Mr. Bahati Charles Department of Mechanical Engineering, Marwadi University, Rajkot – Morbi Highway Road, Gauridad, Rajkot, Gujarat 4. Mr. Ermias gosaye Department of Mechanical Engineering, Marwadi University, Rajkot – Morbi Highway Road, Gauridad, Rajkot, Gujarat , et al.		
Date of Registration	26/04/2023	
Title	MANUAL SCISSOR LIFT	
Priority NA		
Design Number	387718-001	
Class	12-16	
BEML Limited BEML Soudha, No 23/1, 4th Main Rd, Sampangirama Nagara, Bengaluru, Karnataka-560 027		
Date of Registration	06/06/2023	
Title	Axle	
Priority NA		
Design Number	384971-001	
Class	03-01	
SABYASACHI CALCUTTA LLP 80/2 Topsia Road (South), Kolkata-700046, West Bengal.		
Date of Registration	26/04/2023	
Title	BAG	
Priority NA		

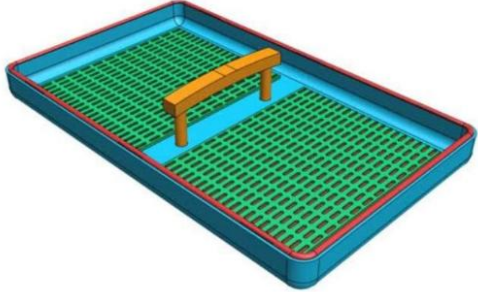
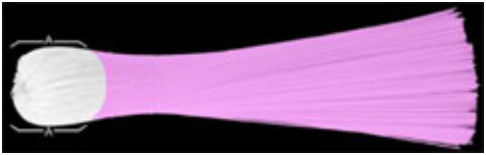
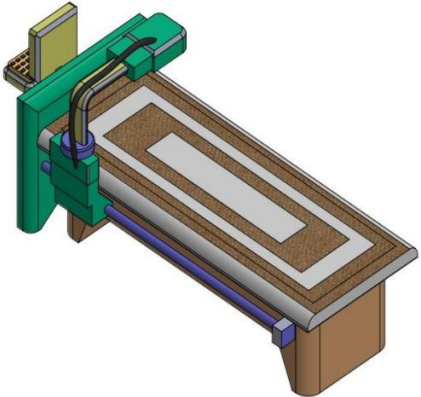
Design Number	385706-003	
Class	06-07	
MICHAEL ARAM INDIA PRIVATE LIMITED MICHAEL ARAM INDIA PRIVATE LIMITED, A-41, SECTOR-80, PHASE-II, NOIDA-201305, U.P INDIA		
Date of Registration	08/05/2023	
Title	MIRROR FRAME.	
Priority NA		
Design Number	367995-001	
Class	23-99	
VELLORE INSTITUTE OF TECHNOLOGY Katpadi, Vellore 632014, Tamilnadu, India		
Date of Registration	19/07/2022	
Title	INCINERATOR FOR THE DISPOSAL OF SANITARY NAPKINS	
Priority NA		
Design Number	339673-001	
Class	12-16	
1.PUBLIC HEALTH FOUNDATION OF INDIA 431A, 4th Floor, Rectangle No.1, Behind Saket Sheraton Hotel, Commercial Complex D4, Saket, New Delhi-110017, India. 2. Dr. SURESH BABU MUNUSWAMY No.4, Kambar Street, Vivekananda Nagar, Chennai-600118, Tamil Nadu, India.		
Date of Registration	24/02/2021	
Title	BOX FRAME OF AN UNMANNED AERIAL VEHICLE	
Priority NA		

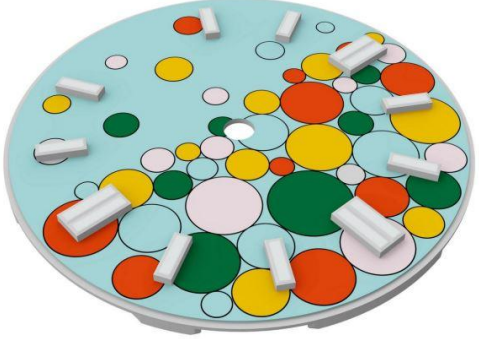
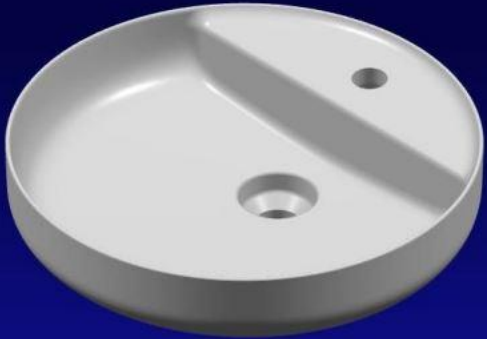
Design Number	385435-001	
Class	08-02	
1. AMITY UNIVERSITY PUNJAB Sector 82A, IT City, International Airport Road, Mohali, Punjab 2. Vishal Kumar Dhiman Amity University Punjab, Sector 82A, IT City, International Airport Road, Mohali, Punjab 3. Neerja Babbar Amity University Punjab, Sector 82A, IT City, International Airport Road, Mohali, Punjab 4. Damanpreet Chugh Amity University Punjab, Sector 82A, IT City, International Airport Road, Mohali, Punjab , et al.		
Date of Registration	02/05/2023	
Title	Slip Proof Hammer	
Priority NA		
Design Number	388626-001	
Class	10-04	
CAPITAL INNOTECH PRIVATE LIMITED E-100. MEWAR INDUSTRIAL AREA, UDAIPUR – 313003, RAJASTHAN, INDIA		
Date of Registration	19/06/2023	
Title	Gas Meter	
Priority NA		
Design Number	383012-001	
Class	23-01	
1. ARPIT KUMAR Bihar Bal Bhawan Kilkari, Campus of Rashtrabhasha, Parisad, Saidpur, Patna-800004, INDIA 2. ABHIJEET KUMAR Bal Bhawan Kilkari, Campus of Rashtrabhasha, Parisad, Saidpur, Patna-800004, INDIA 3. AKSHAT ADARSH Bal Bhawan Kilkari, Campus of Rashtrabhasha, Parisad, Saidpur, Patna-800004, INDIA 4. MD. SADULLAH JAWAID Director, PRANJAL Public Health Engineering Department, Govt of Bihar, # 17 Patliputra, Industrial Area-800012, India		
Date of Registration	04/04/2023	
Title	COMMUNITY WATER FILTER	
Priority NA		

Design Number	379033-001	
Class	14-03	
RAAMTEL SOLUTIONS PRIVATE LIMITED A-72, Sector-63, Noida, Gautam Buddha Nagar, Uttar Pradesh, District Ghaziabad-201301, INDIA.		
Date of Registration	09/02/2023	
Title	MULTIPORT 9 BAND ANTENNA	
Priority NA		
Design Number	391103-001	
Class	08-08	
1. Dr. Neeta Amol Mandhare Flat no. 304, Utkarsha Vihar, Near Kamal Apartment, Sudarshan Nagar, Chinchwad, Pune-411033 2. Dr. K Karunamurthy 43, Adhi Enclave Apartment, Azhagesan Nagar, Kolapakkam, Vandalur-Kelambakkam Road Chennai 600127 3. Dr. Adarsh Abi Mathew Shekinah Thrikkannamangal, Kottarakkara (PO), Kollam, Kerala- 691506 4. Dr. Bharatbhushan S. Kale B-404, Soham CHS, Plot No D-16/1 Sector 20, Airoli, Navi Mumbai - 400708		
Date of Registration	25/07/2023	
Title	NOSE SHAPE NUT	
Priority NA		
Design Number	383781-001	
Class	15-99	
1. Dr. Amitansu Pattanaik Professor, School of Basic and Applied Sciences, Galgotias University, Plot No. 2, Yamuna Expressway, Sector 17A, Gautam Buddha Nagar, Greater Noida, Uttar Pradesh - 201310. 2. Abhishek Singh School of Mechanical Engineering, Lovely Professional University, Jalandhar-Delhi GT Road, Phagwara, Punjab - 144411. 3. Tasnim Zotder School of Computer Science and Engineering, Lovely Professional University, Jalandhar-Delhi GT Road, Phagwara, Punjab – 144411.		
Date of Registration	12/04/2023	
Title	Advanced Salt Extractor	
Priority NA		

Design Number	385469-001	
Class	14-02	
1. Dr. Veena Grover Professor, School of Management, Noida Institute of Engineering & Technology, Greater Noida, 19, Institutional Area, Knowledge Park II, Greater Noida, Uttar Pradesh 201306. 2. Dr. Manju Nandal Assistant Professor, Professional Affiliation: School of Management, Noida Institute of Engineering & Technology, 19, Institutional Area, Knowledge Park II, Greater Noida, Uttar Pradesh 201306. 3. Dr Alka Agnihotri Designation: Assistant Professor , Professional affiliation: Galgotias University Address: Plot No. 2, Yamuna Expressway, opposite Buddha International Circuit, Sector 17A, Greater Noida, Uttar Pradesh 203201 4. Dr. Manisha Singh Designation: Associate Professor, Professional Affiliation: G.L. Bajaj Institute of Management and Research, Plot No. 2, Knowledge Park-III, Greater Noida-201306 , et al.		
Date of Registration	02/05/2023	
Title	DIGITAL BUSINESS MANAGEMENT DEVICE	
Priority NA		
Design Number	386236-001	
Class	02-07	
SHANTI DEVI No. 53, Vaidyanathan Street, Seven Wells, Chennai-600 079		
Date of Registration	15/05/2023	
Title	ZIPPER SLIDER	
Priority NA		
Design Number	387703-001	
Class	24-01	
1. Dr. J. S. Leena Jasmine Professor, Department of Electronics and Communication Engineering, Velammal Engineering College, Chennai – 66, Tamil Nadu, India. 2. Dr. C. Murukesh Associate Professor, Department of Electronics and Communication Engineering, Velammal Engineering College, Chennai – 66, Tamil Nadu, India. 3. Dr. P. Ponsudha Assistant Professor, Department of Electronics and Communication Engineering, Velammal Engineering College, Chennai – 66, Tamil Nadu, India. 4. Dr. K. Thilagam Associate Professor, Department of Electronics and Communication Engineering, Velammal Engineering College, Chennai – 66, Tamil Nadu, India , et al.		
Date of Registration	05/06/2023	
Title	INTELLIGENT CHIP CONTROL OXYGEN CONCENTRATOR	
Priority NA		

Design Number	329317-001	
Class	22-03	
1.Mithilesh Patel 12, Manav, Mandir Society, Diwalipura, O.P. Road, Vadodara 390015 Gujarat 2. Vraj Mithilesh Patel 12, Manav, Mandir Society, Diwalipura, O.P. Road, Vadodara 390015 Gujarat		
Date of Registration	14/05/2020	
Title	SOLAR PANEL EQUIPPED ROCKET	
Priority NA		
Design Number	388650-001	
Class	15-07	
1.Dr Harika B Associate professor Department of Computer Science and Engineering, Rishi M.S Institute of engineering and technology for women, Near JNTUH metro station, Nizampet x road, Kukatpally, Hyderabad -500085 2. Mr. S. Pradeep Assistant Professor, Department of Electronics and Communication Engineering, K.S.Rangasamy College of Technology, Tiruchengode, Namakkal, Tamilnadu, India - 637215 3. Dr. Syed Sumera Ershad Ali Associate Professor Electronics & Computer Engineering Dept. CSMSS Chh.Shahu College of Engineering, Aurangabad, Maharashtra, India, 431001 4. Dr. M. Malathy Professor, Department of Computer Science and Engineering, Vel Tech High Tech Dr.Rangarajan Dr. Sakunthala Engineering College, Thiruvallur Chennai, Tamilnadu, India, 600062.		
Date of Registration	19/06/2023	
Title	PORTABLE BIOMEDICAL REFRIGERATOR	
Priority NA		
Design Number	384186-001	
Class	23-04	
GODREJ CONSUMER PRODUCTS LIMITED Godrej One, 4th Floor, Pirojshanagar, Eastern Express Highway, Vikhroli (East), Mumbai-400079, India.		
Date of Registration	18/04/2023	
Title	FRAGRANCE DISPENSER	
Priority NA		

Design Number	388874-001	
Class	07-09	
<p>1. Dr. J. Manjunathan Assistant Professor, Department of Biotechnology, Vels Institute of Science Technology and Advanced Studies, Pallavaram, Chennai, Tamil Nadu, India. 2. Dr. R. Sudha Associate Professor, Department of Chemistry, Vels Institute of Science Technology and Advanced Studies, Pallavaram, Chennai, Tamil Nadu, India. 3. M. D. Balakumaran Assistant Professor and Head, Department of Biotechnology, Dwaraka Doss Goverdhan Doss Vaishnav College, Chennai, Tamil Nadu, India. 4. Dr. M. Pavithra Assistant Professor, Department of Biotechnology, Dwaraka Doss Goverdhan Doss Vaishnav College, Chennai, Tamil Nadu, India. , et al.</p>		
Date of Registration	22/06/2023	
Title	BEVERAGE CAPSULE TRAY	
Priority NA		
Design Number	357617-001	
Class	24-01	
<p>KURARAY CO., LTD. 1621, Sakazu, Kurashiki-shi, Okayama 710-0801, Japan.</p>		
Date of Registration	31/01/2022	
Title	HOLLOW FIBER MEMBRANE MODULE	
Priority NA		
Design Number	388054-001	
Class	24-01	
<p>1. Adithya Padthe University of the Cumberlands, 6178 College Station Drive, Williamsburg, KY 40769, USA. 2. Arvind Dagur Professor CSE, Galgotias University Plot No.2, Sector 17-A Yamuna Expressway, Greater Noida, Gautam Buddh Nagar, Uttar Pradesh-203201, India. 3. Jagrati Singh Assistant Professor, Centre for Advanced Studies, AKTU Lucknow, Uttar Pradesh, India. 4. Dharendra Kumar Shukla Associate Professor, Galgotias University Plot No.2, Sector 17-A Yamuna Expressway, Greater Noida, Gautam Buddh Nagar, Uttar Pradesh-203201, India.</p>		
Date of Registration	09/06/2023	
Title	MEDICAL IMAGING DEVICE	
Priority NA		

Design Number	387374-001		
Class	10-07		
ROLEX SA rue François -Dussaud 3-5-7, 1211 Genève 26, Switzerland			
Date of Registration	31/05/2023		
Title	WATCH DIAL		
Priority			
Priority Number	Date	Country	
2023-00143	14/03/2023	Switzerland	
Design Number			
385448-001			
Class	23-06		
Duravit Aktiengesellschaft a German company of Werderstraße 36, 78132 Hornberg, Germany.			
Date of Registration	02/05/2023		
Title	SINK WITH TAP HOLE		
Priority			
Priority Number	Date	Country	
WIPO126433	15/12/2022	WIPO	
Design Number			
387982-001			
Class	28-02		
MR. AKSHAY 135, 2ND FLOOR, TAGORE PARK, MODEL TOWN-1, DELHI-110009			
Date of Registration	09/06/2023		
Title	LIPSTICK CASE		
Priority NA			

Design Number	384960-001		
Class	24-02		
1. Marwadi University Rajkot – Morbi Highway Road, Gauridad, Rajkot, Gujarat 360003 2. Dr Lalji Baldaniya Professor, Faculty of Pharmacy, Marwadi University, Rajkot – Morbi Highway Road, Gauridad, Rajkot, Gujarat 3. Mr Vishal Kanzariya Post graduate Student, Faculty of Management Studies, Marwadi University, Rajkot – Morbi Highway Road, Gauridad, Rajkot, Gujarat			
Date of Registration	26/04/2023		
Title	Dual-Chamber Prefilled syringe		
Priority NA			
Design Number	384506-001		
Class	02-03		
August Sixth LLC 251 W. Central Ave. Suite 133, Springboro, Ohio 45066, USA			
Date of Registration	21/04/2023		
Title	HEAD SCARF		
Priority			
Priority Number	Date	Country	
US29/857,892	26/10/2022	U.S.A.	
Design Number	384774-001		
Class	12-11		
DEUSEXVOLT ELECTRIC PRIVATE LIMITED 8-354/A/2, Plot no. 36/37, MNReddy Colony Phase-2, Quthbullapur HYDERABAD TG 500055 IN			
Date of Registration	25/04/2023		
Title	UTILITY TWO WHEELER		
Priority NA			

Design Number	336720-001	
Class	06-11	
M/S EXMART INTERNATIONAL PVT. LTD. 268, SANT NAGAR, EAST OF KAILASH, NEW DELHI-110065., INDIA.		
Date of Registration	23/12/2020	
Title	MAT	
Priority NA		
Design Number	388030-001	
Class	08-05	
VDT Pipeline Integrity Solutions Private Limited IIM Lucknow Noida Campus B1, Block B, Sector 62, Noida-201307, Uttar Pradesh, India		
Date of Registration	09/06/2023	
Title	CLEANING PIG	
Priority NA		
Design Number	385940-001	
Class	06-01	
NILKAMAL LIMITED SURVEY NO-354/2 & 354/3, NEAR RAKHOLI BRIDGE, SILVASSA-KHANVEL ROAD, VILLAGE VASONA, SILVASSA (D & N.H) (U.T), INDIA		
Date of Registration	10/05/2023	
Title	CHAIR	
Priority NA		

Design Number	343144-001	
Class	14-02	
Bloomberg Finance L.P. 731 Lexington Avenue, New York NY 10022, United States		
Date of Registration	07/05/2021	
Title	KEYBOARD	
Priority		
Priority Number	Date	Country
29/762,956	18/12/2020	U.S.A.


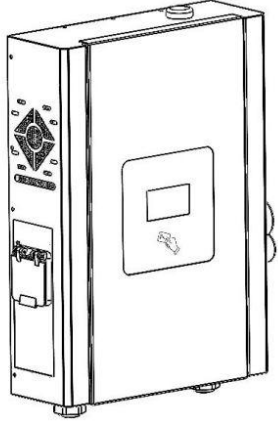
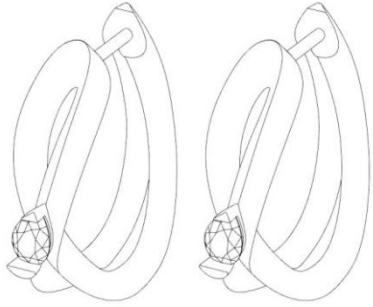


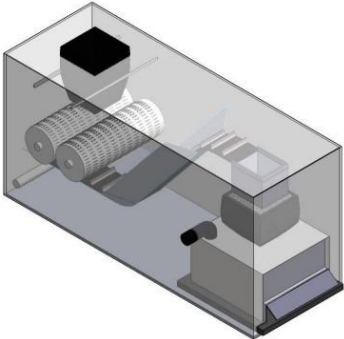


Design Number	384892-001	
Class	21-02	
1. JATIN PALANDE Karnavati University, A/907, Adalaj - Uvarsad Road, Gandhinagar-382422, Gujarat, India 2. RIYA GOWAIKAR Karnavati University, A/907, Adalaj - Uvarsad Road, Gandhinagar-382422, Gujarat, India 3. SHREYA BANE Karnavati University, A/907, Adalaj - Uvarsad Road, Gandhinagar-382422, Gujarat, India 4. SHARAD SHETTY Karnavati University, A/907, Adalaj - Uvarsad Road, Gandhinagar-382422, Gujarat, India , et al.		
Date of Registration	26/04/2023	
Title	PLAYER PERFORMANCE ANALYSER	
Priority NA		

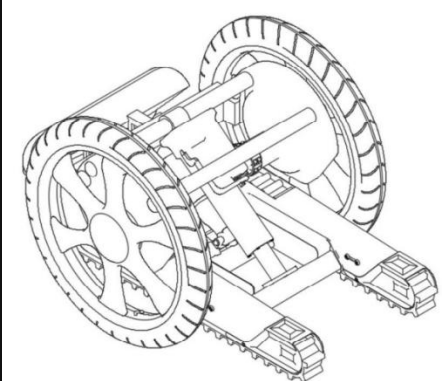
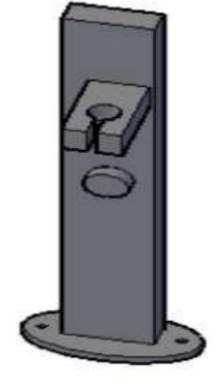



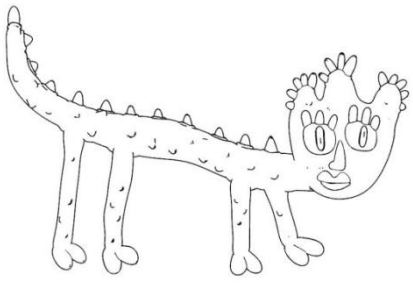


Design Number	387075-001	
Class	12-11	
RAJKUMAR PATEL A/410, Stellar, Sindhubhavan Road, Bodakdev, Ahmedabad, Gujarat - 380059.		
Date of Registration	25/05/2023	
Title	BIKE	
Priority NA		






Design Number	384703-001	
Class	23-04	
SARAVANAN S 4/57, FLAT E, SUSMITHAM APPT, BAGAVATHI AMMAN KOIL ST, SUBASH NAGAR, I.C.F COLONY, AMBATTUR, CHENNAI-600058		
Date of Registration	25/04/2023	
Title	Laminar Airflow System	
Priority NA		
Design Number	387231-001	
Class	13-02	
EFEV Charging Solutions Pvt Ltd G-7/325, Sector -16, Rohini, New Delhi-110089		
Date of Registration	29/05/2023	
Title	ELECTRIC VEHICLE CHARGER	
Priority NA		
Design Number	388255-001	
Class	11-01	
TITAN COMPANY LIMITED Integrity' No.193, Veerasandra, Electronics City P.O., Off Hosur Main Road, Bangalore – 560100		
Date of Registration	13/06/2023	
Title	JEWELLERY	
Priority NA		



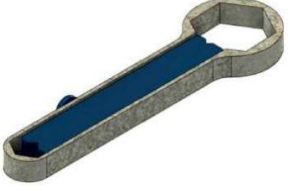
Design Number	387957-001	
Class	15-99	
1.Yashveer Kamlesh Shah 205, Prathmesh Tower, Link road, near Don Bosco School, Mumbai, Borivali, West Mumbai, Maharashtra, 400092 2. Shoolini University of Biotechnology and Management Sciences Shoolini University of Biotechnology and Management Sciences Bajhol, PO Sultanpur, Distt. Solan -173229, India		
Date of Registration	08/06/2023	
Title	Gypsum recycling unit	
Priority NA		
Design Number	389019-001	
Class	06-01	
National Institute of Design Opposite Tagore Hall, Rajnagar Society, Paldi Ahmedabad, Gujarat-380007 India		
Date of Registration	26/06/2023	
Title	STOOL	
Priority NA		
Design Number	385179-001	
Class	12-08	
ANT MOBILITY PVT. LTD. 1 & 1A, UR NAGAR EXTN, ANNA NAGAR WEST EXTN, CHENNAI-600050, TAMIL NADU.		
Date of Registration	28/04/2023	
Title	AMBULANCE	
Priority NA		

Design Number	385757-001	
Class	12-12	
1. Dr. Amit Kumar Srivastava ATS 1G/43, JUET CAMPUS, A.B. ROAD, RAGHOGARH, GUNA 2. Anand Pandey Gayatri Villa,, Sector No. 26, Pradhikaran, Nigdi, Pimpri-Chinchwad, Maharashtra 3. Dr. Ravindra Kumar Singh 3D/78/6, Bhiali, Durg, CG 4. Dr. Pankaj Gupta 366, Mukundpur, Satna, MP. , et al.		
Date of Registration	08/05/2023	
Title	WHEELCHAIR SUBSTRUCTURE	
Priority NA		
Design Number	387974-001	
Class	13-03	
1. Dr. Shachi Mall Post- Doctoral Fellow School of Computer Science Engineering and Technology, Bennett University, (Times of India Group) Plot No. 8-11, Techzone-II, Greater Noida, Uttar Pradesh, India, Pin : 201310 2. Dr. Mohit Payal Assistant Professor ECE Department Graphic Era Hill University, Clement Town, Dehradun, Uttarakhand, Pin 248002. 3. Bharat Tripathi Department of Computer Science & Engineering , Apex Institute of Technology, Chandigarh University, Mohali , Punjab , India Pin: 140413 4. Dr. Mohammad Shuaib Khan Assistant Professor Chitkara University Institute of Engineering and Technology, Chitkara University, Chandigarh- Patiala National Highway (NH-64) Village Jansla, Rajpura, Punjab INDIA Pin: 140401		
Date of Registration	09/06/2023	
Title	EV Charging Stand	
Priority NA		
Design Number	387866-001	
Class	09-03	
Lion Dates Impex (P) Ltd., No: 40, Sterling road, Nungambakkam, Chennai - 600 034, Tamandu, India		
Date of Registration	07/06/2023	
Title	CONTAINER	
Priority NA		

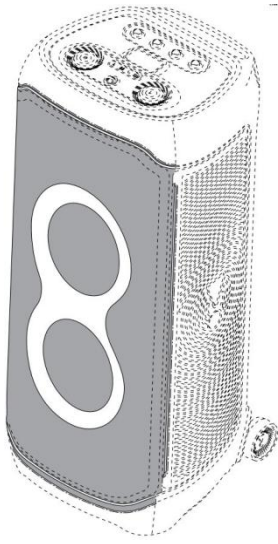

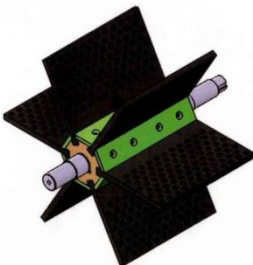
Design Number	388260-001		
Class	11-01		
Kasmira's Moon Limited Venture House, 27-29 Glasshouse Street, London W1B 5DF, United Kingdom			
Date of Registration	13/06/2023		
Title	JEWELLERY		
Priority			
Priority Number	Date	Country	
6249716	14/12/2022	U.K.	
Design Number	388770-001		
Class	06-01		
SBM CHAIR PRIVATE LIMITED, SURVEY NO. – 149, RANI INDUSTRIAL AREA, BEHIND BAJRANG FURNITURE PVT LTD, VAVDI RAJKOT – 360001, GUJARAT, INDIA			
Date of Registration	21/06/2023		
Title	CHAIR		
Priority NA			
Design Number	384914-001		
Class	24-04		
1. ARUSHI SONI Karnavati University, A/907, Adalaj - Uvarsad Road, Gandhinagar-382422, Gujarat, India 2. SIDDHI BUTTEPATIL Karnavati University, A/907, Adalaj - Uvarsad Road, Gandhinagar-382422, Gujarat, India 3. VAIBHAV KUSHWAHA Karnavati University, A/907, Adalaj - Uvarsad Road, Gandhinagar-382422, Gujarat, India 4. SAHANA SIVARAMAKRISHNAN Karnavati University, A/907, Adalaj - Uvarsad Road, Gandhinagar-382422, Gujarat, India , et al.			
Date of Registration	26/04/2023		
Title	ORTHOPAEDIC HEATING AND VIBRATING PAD		
Priority NA			




Design Number	386782-001		
Class	24-03		
1. Dr. Abdul Hameed Attar 404 A3 Asmita Anita, Near Wockhard Hospital, Mira Road East, Thane, Maharashtra-401107, India. 2. Dr. Rabiya Koya 404 A3 Asmita Anita, Near Wockhard Hospital, Mira Road East, Thane, Maharashtra-401107, India. 3. Dr. Hiroj Bagde 403, Staff Accommodations, Rama Dental College, Kanpur, Uttar Pradesh- 208024, India. 4. Dr. Ashwini Dhopte 403, Staff Accommodations, Rama Dental College, Kanpur, Uttar Pradesh- 208024, India.			
Date of Registration	22/05/2023		
Title	BIO ROOT DENTAL IMPLANT		
Priority NA			
Design Number	358896-001		
Class	02-06		
1. Dr. K. Periasamy Professor, Department of Mechanical Engineering, Kongunadu College of Engineering and Technology, Thottiyam, Trichirapalli - 621215, Tamilnadu, India 2. Dr. D. Jagadeesh Associate Professor, Department of Mechanical Engineering, Kongunadu College of Engineering and Technology, Thottiyam, Trichirapalli - 621215, Tamilnadu, India 3. Dr. G. Saravanan Associate Professor, Department of Mechanical Engineering, Kongunadu College of Engineering and Technology, Thottiyam, Trichirapalli - 621215, Tamilnadu, India 4. Mr. R. Karthik Assistant Professor, Department of Mechanical Engineering, Kongunadu College of Engineering and Technology, Thottiyam, Trichirapalli - 621215, Tamilnadu, India , et al.			
Date of Registration	21/02/2022		
Title	GLOVES FOR SWEEPERS		
Priority NA			
Design Number	371297-001		
Class	13-04		
1. ZHEJIANG AIKO SOLAR ENERGY TECHNOLOGY CO., LTD. NO. 655, HAOPAI ROAD, SUXI TOWN, YIWU CITY, ZHEJIANG PROVINCE, CHINA 322000 2. ZHUHAI FUSHAN AIKO SOLAR ENERGY TECHNOLOGY CO., LTD. Room 139, No. 6, Zhufeng Avenue West, Fushan Industrial Park, Doumen District, Zhuhai City, CHINA 519000 3. TIANJIN AIKO SOLAR ENERGY TECHNOLOGY CO., LTD. NO. 73, GAOXIN AVENUE, SCIENCE AND TECHNOLOGY PARK, BEICHEN ECONOMIC AND TECHNOLOGICAL DEVELOPMENT ZONE, BEICHEN DISTRICT, TIANJIN, CHINA 300400 4. GUANGDONG AIKO SOLAR ENERGY TECHNOLOGY CO., LTD. NO. 3, SOUTH QILI AVENUE, LEPING TOWN, SANSHUI DISTRICT, FOSHAN, GUANGDONG, CHINA 528000			
Date of Registration	23/09/2022		
Title	BATTERY CHIP		
Priority			
Priority Number	Date	Country	
202230154552.3	23/03/2022	China	




Design Number	387601-001	
Class	29-02	
1. DKTE Society's Textile and Engineering Institute Rajwada, Ichalkaranji, Maharashtra 416115 2. Prof. Vinayak B. Sutar DKTE Society's Textile and Engineering Institute, Ichalkaranji, India 416115 3. Dr. K. V. Kulhalli DKTE Society's Textile and Engineering Institute, Ichalkaranji, India 416115 4. Dr. Shrinivas A. Patil DKTE Society's Textile and Engineering Institute, Ichalkaranji, India 416115		
Date of Registration	04/06/2023	
Title	SMART ROAD STUD FOR ROAD SAFETY	
Priority NA		
Design Number	389033-001	
Class	26-05	
Jayesh Vishwakarma 9, Dashrathnagar Society, LH Road, Varachha, Surat – 395006, Gujarat, India		
Date of Registration	26/06/2023	
Title	DESK LAMP	
Priority NA		
Design Number	386531-001	
Class	31-00	
1. Dr. Suresh Kumar Agarwal Director International Institute of Lifestyle Medicine 66A, Alipore Road Kolkata-700027, West Bengal, India. 2. Dr. U. Karthika Priyadharshini Assistant professor, Department of Physiology, Jawaharlal Institute of Postgraduate Medical Education and Research (JIPMER), Pondicherry 605006 3. Dr. Brahmam Pasumarthi Associate professor, Biology, Department of Humanities and Sciences, PACE Institute of Technology and Sciences, Ongole, Prakasam- 523 001 Andhra Pradesh, India 4. Dr. Manisha Associate Professor and Head of Botany Department, Chinmaya Degree College, BHEL, Haridwar College is Affiliated to Hemwati Nandan Bahuguna Garhwal University, Srinagar, Garhwal, Uttarakhand-249403, India , et al.		
Date of Registration	18/05/2023	
Title	HERBAL DRINK GRINDER AND MAKER	
Priority NA		

Design Number	385205-001	
Class	12-11	
Hero MotoCorp Limited Hero MotoCorp Limited The Grand Plaza, Plot No.2, Nelson Mandela Road, Vasant Kunj- Phase -II, New Delhi, India, 110 100		
Date of Registration	28/04/2023	
Title	BODY COVER	
Priority NA		
Design Number	384550-001	
Class	14-01	
Ankit Mohanbhai Vadodariya B 1204, Hampton Park, Opp. Aagam Arcade, Vesu, Surat – 395007, Gujarat, India		
Date of Registration	22/04/2023	
Title	Speaker	
Priority NA		
Design Number	385162-001	
Class	08-05	
1. Quantum University Quantum University, Roorkee, Uttarakhand- 247167, India 2. Mr. Mukesh Kumar Assistant Professor, Department of Mechanical Engineering, Quantum University, Roorkee, Uttarakhand- 247167, India 3. Dr. Amit Dixit Professor & Registrar, Quantum University, Roorkee, Uttarakhand- 247167, India 4. Mr. Surinder Kumar Assistant Professor, Department of Mechanical Engineering, Quantum University, Roorkee, Uttarakhand- 247167, India		
Date of Registration	28/04/2023	
Title	Adjustable Spanner	
Priority NA		

Design Number	386519-001	
Class	09-01	
PETUELA INDUSTRIES., 109, MANISH INDUSTRIAL ESTATE NO. 1, NAVGHAR VILLAGE, VASAI ROAD (EAST), DIST – PALGHAR – 401 210.		
Date of Registration	18/05/2023	
Title	BOTTLE	
Priority NA		
Design Number	384791-001	
Class	07-02	
1. VINEET NADAR Karnavati University, A/907, Adalaj - Uvarsad Road, Gandhinagar-382422, Gujarat, India 2. SWETA DALAL Karnavati University, A/907, Adalaj - Uvarsad Road, Gandhinagar-382422, Gujarat, India 3. KARNAVATI UNIVERSITY Karnavati University, A/907, Adalaj - Uvarsad Road, Gandhinagar-382422, Gujarat, India		
Date of Registration	26/04/2023	
Title	CHAKLI MAKER DEVICE	
Priority NA		
Design Number	391107-001	
Class	02-04	
RAJITHA DHANEKULA 48-16-39-1, A 302, Sitaramaswamy Residency, Kanakadurga Street, Vijayawada-520008, Andhra Pradesh, India.		
Date of Registration	13/07/2023	
Title	ACCESSORIES FOR SHOES	
Priority NA		

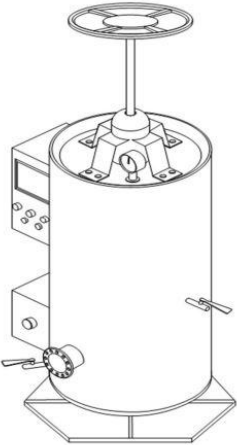


Design Number	384747-001		
Class	14-01		
Harman International Industries, Incorporated 8500 Balboa Blvd., Northridge, California 91329, United States of America			
Date of Registration	25/04/2023		
Title	Loudspeaker		
Priority			
Priority Number	Date	Country	
29/869389	29/12/2022	U.S.A.	
Design Number	384440-001		
Class	26-03		
1. Dr. Amzad Basha Kolar Assistant Professor, P.G Department of Botany, The New College (Autonomous), Affiliated to University of Madras, Chennai-600014, Tamil Nadu, India 2. Dr. N.P. M. Mohamed Tariq Assistant Professor of Botany, Department of Biotechnology Islamiah College (Autonomous) Affiliated to Thiruvalluvar University, Vaniyambadi-635 752, Thirupattur, Tamil Nadu, India. 3. Dr. Shaik Azeem Taj Assistant Professor, Department of Botany, Justice Basheer Ahmed Sayeed College for Women (Autonomous) Affiliated to University of Madras, Chennai-600018, Tamil Nadu, India. 4. Dr. Mary Kensa V Assistant Professor of Botany, PG and Research Centre of Botany, S.T.Hindu College, Affiliated to Manonmaniam Sundaranar University, Nagercoil-629 002, Tamil Nadu, India , et al.			
Date of Registration	20/04/2023		
Title	PHOTOSYNTHETIC STREET LAMPS POWERED BY ALGAE		
Priority NA			
Design Number	385805-001		
Class	15-03		
MR SHANMUGAN PALANISAMY 1/8, VAIYAPURI NAGAR, VALIAMPALAYAM, SAKTY ROAD, NEAR S.N.S COLLEGE OF TECHNOLOGY, COIMBATORE, SARAVANAMPATTI, COIMBATORE, TAMILNADU-641035			
Date of Registration	09/05/2023		
Title	RUBBER FLIP SHAFT ASSEMBLY FOR COCONUT DEHUSKING MACHINE		
Priority NA			


Design Number	385425-001	
Class	06-03	
1. AMITY UNIVERSITY PUNJAB Sector 82A, IT City, International Airport Road, Mohali, Punjab 2. Dr. Shashi Bhushan Amity University Punjab Sector 82A, IT City, International Airport Road, Mohali, Punjab 3. Mr. Vinod Raturi Amity University Punjab Sector 82A, IT City, International Airport Road, Mohali, Punjab		
Date of Registration	02/05/2023	
Title	IOT Based Study Table with Book Stand	
Priority NA		
Design Number	384724-001	
Class	12-05	
Presstonic Engineering Pvt. Ltd Survey No. 2, Khata No.145, Srigandadakavalu A Main Road, Pillappa Industrial Area, Hoysala Main Road IN, Hoysala Nagar, Industrial Layout, Sunkadakatte, Bengaluru, Karnataka 560091, India		
Date of Registration	25/04/2023	
Title	Retractable Ramp Assembly	
Priority NA		
Design Number	388809-001	
Class	12-11	
MATTER MOTOR WORKS PRIVATE LIMITED 301, PARISHRAM BUILDING, 5B RASHMI SOC., NR. MITHAKHALI SIX ROADS, NAVRANGPURA AHMEDABAD, GUJARAT, INDIA - 380009		
Date of Registration	22/06/2023	
Title	FOOT PEG FOR TWO WHEELED VEHICLE	
Priority NA		

Design Number	388109-001	
Class	07-01	
M/s Nayasa Superplast a partnership concern Survey No. 370/2 (7) Kachigam, Nani Daman, Daman- 396 210, (Union Territory of India)		
Date of Registration	10/06/2023	
Title	SET OF BOWLS WITH TRAY	
Priority NA		
Design Number	388946-001	
Class	13-02	
Luminous Power Technologies Pvt. Ltd. C56, Mayapuri Industrial Area, Phase-II, Mayapuri, New Delhi- 110064		
Date of Registration	23/06/2023	
Title	Battery Terminal Protector	
Priority NA		
Design Number	387985-001	
Class	25-01	
Kamdhenu Limited 2nd Floor, Tower-A Building No.9, DLF Cyber City Phase-3, Gurgaon – 122 002 (Haryana)		
Date of Registration	09/06/2023	
Title	STEEL BAR	
Priority NA		

Design Number	361228-001	
Class	29-02	
CARBORUNDUM UNIVERSAL LIMITED an Indian Company of Parry House- 6th Floor, 43 Moore Street, Chennai 600001, India.		
Date of Registration	25/03/2022	
Title	RESCUE CAP	
Priority NA		
Design Number	386983-001	
Class	12-16	
Sachin Anant Jadhav A-5 Echinus Court Balewadi Pune 411045		
Date of Registration	24/05/2023	
Title	HUB MOTOR FOR ELECTRIC SMART BIKE	
Priority NA		
Design Number	384486-001	
Class	24-02	
1. Rohan Krishna Barse Yashwantrao Bhonsale College of Pharmacy, BKC02, Vazarwadi, Tal: Sawantwadi, Dist: Sindhudurga, Maharashtra- 416510 2. Jatin Arun Tekawade Yashwantrao Bhonsale College of Pharmacy, BKC02, Vazarwadi, Tal: Sawantwadi, Dist : Sindhudurga , Maharashtra- 416510 3. Tushar Ganpat Rukari Yashwantrao Bhonsale College of Pharmacy, BKC02, Vazarwadi, Tal: Sawantwadi, Dist : Sindhudurga , Maharashtra- 416510 4. Vishal Gokul Beldar A-004, Haridwar Ganga Society, Bhatibandar Road, Agashi, Virar West, Tal-Vasai, Dist.: Palghar. Maharashtra - 401302 , et al.		
Date of Registration	21/04/2023	
Title	REFITTING CLASP FOR FRANZ DIFFUSION CELL	
Priority NA		


Design Number	385348-001		
Class	13-03		
Aerolite Industries Unit No – 5/10, Sati Industrial Estate, I. B. Patel Road, Goregaon – East, Mumbai – 400063			
Date of Registration	29/04/2023		
Title	SWITCH PLATE		
Priority NA			
Design Number	385093-001		
Class	02-02		
1. Graphic Era Hill University, Dehradun Campus 510, Society Area, Clement Town, Dehradun – 248002, Uttarakhand, India. 2. Graphic Era Deemed to be University, Dehradun Bell Road, Clement Town Dehradun, Uttarakhand, 248002, India. 3. Ms. Shristha Bhandari Assistant Professor, Department of Design (Fashion Design), Graphic Era Hill University. 4. Prof. Jyoti Chhabra Dean School of Design, Department of Design (Fashion Design), Delhi University.			
Date of Registration	27/04/2023		
Title	Lapel Collar Women Blazer		
Priority NA			
Design Number	383228-001		
Class	14-02		
Holoride GmbH Schellingstr. 45, 80799 Munich, Germany			
Date of Registration	06/04/2023		
Title	MOTION CAPTURE DEVICE		
Priority			
Priority Number	Date	Country	
WIPO125893	02/12/2022	WIPO	

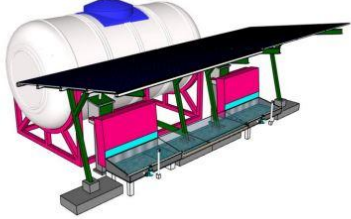
Design Number	384528-001	
Class	24-01	
1. Dr. Vivek Subhash Tarate House No. 13, Raghukul Bungalow, Shivtej Colony, Shahunagar, Godoli, Satara, Maharashtra - 415001 2. Poonam N. Chougule Associate Professor, Ashokrao Mane College of Pharmacy, Peth-Vadgaon, Maharashtra - 416112 3. Dr. Vikram R. Shinde Principal, Late Adv. Dadasaheb Chavan Memorial Institute of Pharmacy, Malwadi, Maharashtra - 415106 4. Mr. Amar Shripati Kulkarni Associate Professor, A/p- Dhamni, Tasgaon, Sangli, Maharashtra - 416314 , et al.		
Date of Registration	21/04/2023	
Title	HIGH-TECH AUTOCLAVE FOR ULTRA-CLEAN STERILIZATION IN PHARMACEUTICAL LABORATORIES	
Priority NA		
Design Number	388961-001	
Class	23-04	
Crompton Greaves Consumer Electricals Limited Equinox Business Park, Tower 3, 1st Floor, East Wing, LBS Marg, Kurla (West), Mumbai - 400 070, Maharashtra, India		
Date of Registration	23/06/2023	
Title	Pedestal Fan	
Priority NA		
Design Number	385364-001	
Class	12-12	
1. Mrs. KALPANA DEVI S ASSISTANT PROFESSOR, COMPUTER SCIENCE AND ENGINEERING, CMR UNIVERSITY, DEPARTMENT OF CSE, SOET, LAKESIDE CAMPUS, CHAGALAHATTI, BENGALURU, KARNATAKA-562149, INDIA 2. MAYANK SHEKHAR PHD STUDENT, COMPUTER SCIENCE AND ENGINEERING , NATIONAL INSTITUTE OF TECHNOLOGY, SILCHAR, ASSAM-78801, INDIA 3. Dr. SUSHMA JAISWAL ASSISTANT PROFESSOR, COMPUTER SCIENCE & INFORMATION TECHNOLOGY (CSIT) , GURU GHASIDAS VISHWAVIDYALAYA (A CENTRAL UNIVERSITY), BILASPUR (CHHATTISGARH) 495009, BILASPUR, CHHATTISGARH, INDIA 4. Dr. ALOK KUMAR SARAN ASSISTANT PROFESSOR, ENERGY AND ENVIRONMENTAL SCIENCES, CHAUDHARY DEVI LAL UNIVERSITY, SIRSA, HARYANA-125055, INDIA , et al.		
Date of Registration	01/05/2023	
Title	SMART WHEELCHAIR	
Priority NA		


Design Number	387840-001	
Class	24-02	
<p>1. Dr. Arvind Kumar Sharma Assistant Professor, Yogananda School of AI, Computers and Data-Science, Shoolini University, Solan, Himachal Pradesh, India 173211 2. Dr. Gousia Habib Post-Doctoral Researcher, Department of Electrical Engineering, Indian Institute of Technology (IIT) New Delhi Hauz Khas, New Delhi, India 3. Savita Wadhwa Assistant Professor, Maharishi Markandeshwar Institute of Computer Technology and Business Management, Maharishi Markandeshwar (Deemed to be) University, Mullana, Haryana, India. 4. Himani Soni Nursing Sister, Maharishi Markandeshwar Super Speciality Hospital, Maharishi Markandeshwar (deemed to be) University, Mullana, Haryana, India</p>		
Date of Registration	07/06/2023	
Title	INTELLIGENT MEDICATION MANAGEMENT DEVICE	
Priority NA		
Design Number	382970-001	
Class	02-03	
<p>STUDDS ACCESSORIES LIMITED Plot No. 918, Sector 68, IMT Faridabad -121004, Haryana, India, also having work place at - 23/7, Mathura Road, Ballabhgarh, Faridabad – 121 004, Haryana, India,</p>		
Date of Registration	04/04/2023	
Title	HELMET	
Priority NA		
Design Number	388102-001	
Class	24-02	
<p>1. Dr. Vijay Agarwal Professor, Raj Kumar Goel Institute of Technology (Pharmacy), 5th Km stone, Delhi - Meerut Road, Gha 2. Mr. Surya Goel Assistant Professor, Raj Kumar Goel Institute of Technology (Pharmacy), 5th Km stone, Delhi - Meerut Road, Ghaziabad, Uttar Pradesh - 201003 3. Dr. Munendra Mohan Varshney Professor, Dean (SW), Raj Kumar Goel Institute of Technology (Pharmacy), 5th Km stone, Delhi - Meerut Road, Ghaziabad, Uttar Pradesh - 201003 4. Ms. Ruchi Singh Assistant Professor, Raj Kumar Goel Institute of Technology (Pharmacy), 5th Km stone, Delhi - Meerut Road, Ghaziabad, Uttar Pradesh - 201003 , et al.</p>		
Date of Registration	10/06/2023	
Title	TEMPERATURE ASSISTING SMART PROBE-ULTRA SONICATOR FOR CONTROLLING THE PARTICLE SIZE	
Priority NA		

Design Number	386096-001	
Class	07-01	
CHIRAG KISHORBHAI MAKADIYA CARVING ECO SOLUTION, SHED NO 2, PLOT NO 22 & 23, SOMNATH INDUSTRIAL-1, KOTHARIYA, RAJKOT-360002, GUJARAT, INDIA		
Date of Registration	12/05/2023	
Title	COFFEE MUG	
Priority NA		
Design Number	388886-001	
Class	15-99	
1. Debasmita Das Assistant Professor, Mata Gujri College Of Pharmacy, Mata Gujri University, Purabpalli Road, Kishanganj, Pin- 855107, Bihar 2. Dr. Biswajit Basu Professor, Department of Pharmaceutical Technology, School of Medical Sciences, Adamas University, Barasat, Kolkata, Pin 700126 3. Jyotirmoy Das Research Scholar, Department of pharmaceutical technology, University of north bengal, 734013 4. Charan Singh Principal, Bhartiyaam College of Pharmacy, Faridabad, Haryana, et al.		
Date of Registration	22/06/2023	
Title	SMART HAND OPERATED TABLET COATING MACHINE	
Priority NA		
Design Number	312119	
Class	23-03	
STEAMLOK ENGINEERING PRIVATE LIMITED PLOT NO. 44, TINY INDUSTRIAL CO. OP. ESTATE LTD, KONDHWA BUDRUK, PUNE 411048		
Date of Registration	16/11/2018	
Title	THERMODYNAMIC STEAM TRAP	
Priority NA		

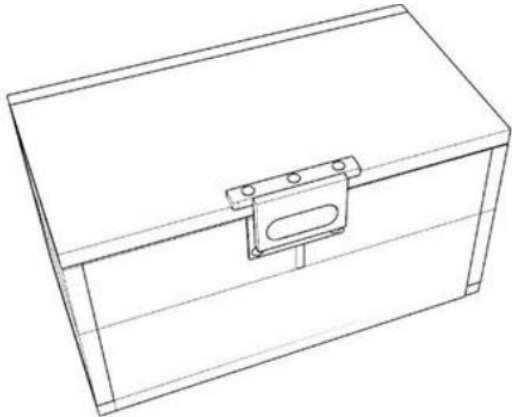
Design Number	386280-001	
Class	15-09	
1. Dr. Manu Srivastava PI, SERB/SPG, Assistant Professor, Department of Mechanical Engineering, PDPM IIITDM Jabalpur, Airport Rd, Khamaria, Jabalpur, Madhya Pradesh 482005 India 2. Dr. Sandeep Rathee Co-PI, SERB/SPG, Assistant Professor, Department of Mechanical Engineering, National Institute of Technology, Srinagar, Hazratbal, Srinagar, Jammu and Kashmir 190006 India 3. Dr. Pulak M Pandey Co-PI, SERB/SPG, Director, Bundelkhand Institute of Engineering & Technology (BIET) Jhansi, 284128 U.P. India		
Date of Registration	15/05/2023	
Title	Apparatus for Hybrid Additive Manufacturing of Metallic Materials to Create Functional Components	
Priority NA		
Design Number	369786-001	
Class	25-01	
Mr. Pranav Deepak Soni Soni bungalow, Brij Bhawan, Opposite ITI, Bhawani Nagar, Burudgaon Road, Ahmednagar- 414001, Maharashtra, India		
Date of Registration	25/08/2022	
Title	KERB STONE PLATE	
Priority NA		
Design Number	385434-001	
Class	02-01	
Ashvin Vishnu Ade A/703, Versova CHSL, Plot-2, S.V.P. Nagar, Mhada, Opp. Telephone Exchange, Andheri West, Azad Nagar, Mumbai, Maharashtra 400053.		
Date of Registration	02/05/2023	
Title	Boxer (an Underwear)	
Priority NA		

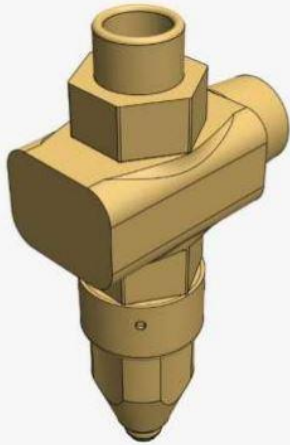
Design Number	388123-001	
Class	09-05	
1.D.Y. Patil College of Engineering & Technology Kasaba Bawada, Kolhapur, Maharashtra 416006 2. Taruna Shrikant Jadhav D.Y. Patil College of Engineering & Technology Kasaba Bawada, Kolhapur, Maharashtra 416006		
Date of Registration	10/06/2023	
Title	TEA FILTER BAG	
Priority NA		


Design Number	385384-001	
Class	13-04	
1.Dr . MALMARUGAN DEVANATHAN CONSULTANT, RESEARCH CONSULTANCY, COIMBATORE, TAMILNADU-641004, INDIA. 2. Dr. TARTE SHILPA HANMANTRAO ASSISTANT PROFESSOR, AGRICULTURAL BIOTECHNOLOGY, MGM COLLEGE OF AGRICULTURAL BIOTECHNOLOG, CHHATRAPATI SAMBHAJINAGAR, AURANGABAD, MAHARASHTRA-431005, INDIA. 3. Ms. MANPREET KAUR AIDEN ASSISTANT PROFESSOR, COMPUTER SCIENCE AND ENGINEERING, MAHARISHI UNIVERSITY OF INFORMATION TECHNOLOGY, GREATER NOIDA, UTTAR PRADESH-201304, INDIA. 4. Ms. SHWETA MAYOR SABHARWAL ASSISTANT PROFESSOR, COMPUTER SCIENCE AND ENGINEERING, GALGOTIAS UNIVERISTY , GREATER NOIDA, UTTAR PRADESH-201306, INDIA. , et al.		
Date of Registration	01/05/2023	
Title	SOLAR DESALINATION SYSTEM	
Priority NA		

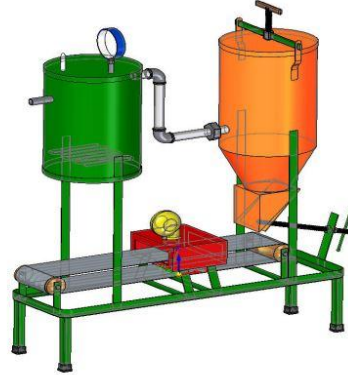
Design Number	385084-001	
Class	02-04	
M/S WALKAROO INTERNATIONAL PRIVATE LIMITED PLOT NO.10-12 INDUSTRIAL ESTATE, MALUMICHAMPATTI, COIMBATORE, TAMIL NADU 641050		
Date of Registration	27/04/2023	
Title	FOOTWEAR	
Priority NA		

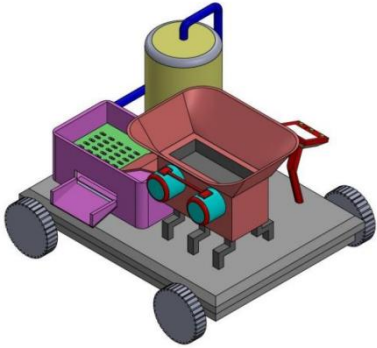
Design Number	384518-001	
Class	15-03	
1.DR. M. XAVIER SURESH DR M XAVIER SURESH, ASSOCIATE PROFESSOR, SCHOOL OF ADVANCED SCIENCES AND LANGUAGES, VIT BHOPAL UNIVERSITY, KOTHRIKALAN, SEHORE, MADYA PRADESH-466114 2. MR. M. CHRISTU RAJAN MR M CHRISTU RAJAN, 4-111, KEEZHAKALKURICHY, THUCKALAY POST, KANYAKUMARI DISTT, TAMILNADU-629175		
Date of Registration	21/04/2023	
Title	BANANA FIBER EXTRACTOR	
Priority NA		
Design Number	387925-001	
Class	02-04	
TULA PACKAGING PRIVATE LIMITED Tyre Puncture,Shop,89/443/671/11, LalatajpatRaiRoad,Ashram Para,Siliguri, Darjeeling, West Bengal, 734001		
Date of Registration	08/06/2023	
Title	SHOE	
Priority NA		
Design Number	384467-001	
Class	24-02	
1.Abhijeet Arvind Raut Research Scholar, Department of Mechanical Engineering, Visvesvaraya National Institute of Technology (VNIT), Nagpur 2. Dr. P. M. Padole Professor, Department of Mechanical Engineering, Visvesvaraya National Institute of Technology (VNIT), Nagpur 3. Dr. Rashmi Uddhanwadikar Professor, Department of Mechanical Engineering, Visvesvaraya National Institute of Technology (VNIT), Nagpur		
Date of Registration	21/04/2023	
Title	VASCULAR ANASTOMOSIS DEVICE FOR HEMODIALYSIS	
Priority NA		

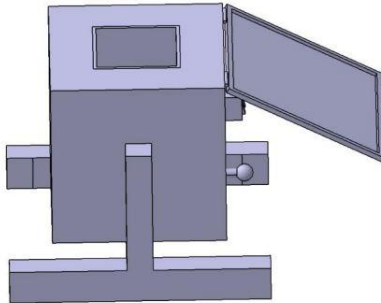
Design Number	384835-001	
Class	09-03	
1. VEDIKA JOSHI Karnavati University, A/907, Adalaj - Uvarsad Road, Gandhinagar-382422, Gujarat, India 2. SHWETA RAI Karnavati University, A/907, Adalaj - Uvarsad Road, Gandhinagar-382422, Gujarat, India 3. KARNAVATI UNIVERSITY Karnavati University, A/907, Adalaj - Uvarsad Road, Gandhinagar-382422, Gujarat, India		
Date of Registration	26/04/2023	
Title	WOODEN BOX	
Priority NA		


Design Number	387965-001	
Class	23-01	
1. Prof.(Dr.) Nidagurthi Guggulla Raghavendra Rao Professor, Department of Pharmaceutics, KIET School of Pharmacy, KIET Group of Institutions, Delhi-NCR, Muradnagar, Ghaziabad-201206, UP. Dr. A.P.J. Abdul Kalam Technical University, Lucknow, Uttar Pradesh, India. 2. Dr. Gampa Vijaya Kumar Professor and Principal, Department of Pharmacy, KGR Institute of Technology and Management, Ranpally, Hyderabad, Telangana, India. 3. Dr. Ramesh Babu Janga Professor, Chebrolu Hanumaiah Institute of Pharmaceutical Sciences, Chandramoulipuram, Chowdavaram, Guntur- 522019, Andhra Pradesh, India.		
Date of Registration	08/06/2023	
Title	SPRAY NOZZLE FOR COATING PHARMACEUTICAL PRODUCTS	
Priority NA		

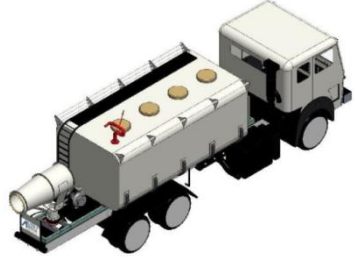


Design Number	383215-001	
Class	14-02	
1. Dr. Gopal Shrinivas Jahagirdar Professor, Mulshi Institute of Business Management, Pune- 412108, Maharashtra, India 2. Prof. Anil Srivastava Assistant Professor, ISB&M College of Commerce, SPPU, Pune, Maharashtra, India 3. Dr. Vajid N. Khan Associate Professor, KJCOEMR, Pune, Maharashtra, India. 4. Prof. Nitin Kisan Deshmane Academic Chairperson, Mulshi Institute of Business Management, Pune- 412108, Maharashtra, India , et al.		
Date of Registration	06/04/2023	
Title	IOT-BASED DATA MANAGER DEVICE	
Priority NA		

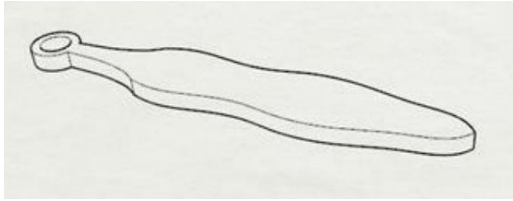


Design Number	384902-001	
Class	31-00	
1.PRANAV GONDALIA Karnavati University, A/907, Adalaj - Uvarsad Road, Gandhinagar-382422, Gujarat, India 2. SHYAMBIHARI PRAJAPATI Karnavati University, A/907, Adalaj - Uvarsad Road, Gandhinagar-382422, Gujarat, India 3. KARNAVATI UNIVERSITY Karnavati University, A/907, Adalaj - Uvarsad Road, Gandhinagar-382422, Gujarat, India		
Date of Registration	26/04/2023	
Title	JUICER	
Priority NA		
Design Number	385424-001	
Class	26-05	
1.AMITY UNIVERSITY PUNJAB Sector 82A, IT City, International Airport Road, Mohali, Punjab 2. Mr. Vinod Raturi Amity University Punjab Sector 82A, IT City, International Airport Road, Mohali, Punjab 3. Dr. Shashi Bhushan Amity University Punjab Sector 82A, IT City, International Airport Road, Mohali, Punjab		
Date of Registration	02/05/2023	
Title	IOT Based Modern (Box) Light Lamp	
Priority NA		
Design Number	384590-001	
Class	31-00	
1.Kolhapur Institute of Technology's College of Engineering (Autonomous), Kolhapur Gokul Shirgaon, Maharashtra 416234 2. Uday Shivaji Bhapkar Row House No 20, Vishwakarma Park, Pratibhanagar, Kolhapur 416008. 3. Mrs. Nayan Santosh Kothale Shivashakti colony , shahunagar , Jaysingpur .Tal - shirol , dist - Kolhapur 4. Mrs .Sanjivani Vishal Mali At Shivade Post Umbraj , Tal. Karad , Dist. Satara , et al.		
Date of Registration	22/04/2023	
Title	AUTOMATIC TURMERIC PROCESSING MACHINE	
Priority NA		

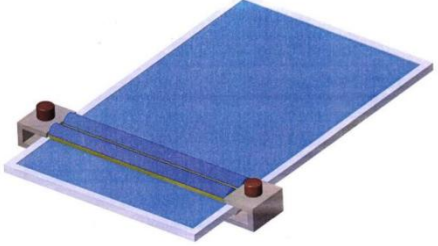

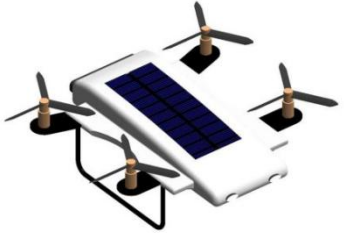
Design Number	389051-001	
Class	15-05	
1. Allwin D Assistant Professor/ Civil Engineering Noorul Islam Centre for Higher Education, Kanyakumari, India-629180. 2. Neela Rajan R R Assistant Professor/ Aeronautical Engineering Noorul Islam Centre for Higher Education, Kanyakumari, India-629180. 3. Mathan Kumar S Assistant Professor/ Civil Engineering Noorul Islam Centre for Higher Education, Kanyakumari, India-629180. 4. J Divya Johns Assistant Professor/ Civil Engineering Noorul Islam Centre for Higher Education, Kanyakumari, India-629180.		
Date of Registration	26/06/2023	
Title	IOT BASED WASHING MACHINE FOR AGRICULTURAL CROPS	
Priority NA		


Design Number	385250-001	
Class	23-08	
1. Mr. Santosh Swain Mr. Santosh Swain, Nuagan, PO. Tarava, Dhenkanal-759013, Odisha 2. Dr. Sudhansu Sekhar Sahoo Department of Mechanical Engineering, OUTR, Bhubaneswar, 751029, Odisha 3. Dr. Manoj Kumar Nayak Department of Mechanical Engineering, ITER, Siksha 'O' Anusandhan University, Bhubaneswar, 751030, Odisha 4. Dr. Rati Ranjan Dash E-311, Trident Galaxy, Ghatikia Mahalaxmi Vihar, Bhubaneswar, 751029, Odisha , et al.		
Date of Registration	28/04/2023	
Title	Dry Sanitizer	
Priority NA		

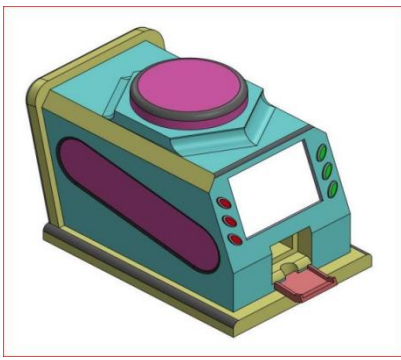
Design Number	387710-001	
Class	24-01	
1. Dr. R. S. VINOD KUMAR Professor, Department of Electronics & Communication Engineering, Noorul Islam Centre For Higher Education, Kumaracoil – 629180, Tamil Nadu, INDIA. 2. Dr. T. GOPALAKRISHNAN Head, Department of Electronics & Communication Engineering, Noorul Islam Centre For Higher Education, Kumaracoil – 629180, Tamil Nadu, INDIA. 3. Dr. S. S. KUMAR Associate Professor & Head, Department of Electronics & Instrumentation Engineering, Noorul Islam Centre For Higher Education, Kumaracoil – 629180, Tamil Nadu, INDIA. 4. Dr. G. DEEPA Assistant Professor of Physics, Pioneer Kumaraswamy College, Nagercoil – 629003, Tamil Nadu, INDIA. , et al.		
Date of Registration	06/06/2023	
Title	LUNG CANCER TESTING DEVICE	
Priority NA		


Design Number	384697-001	
Class	12-13	
Shree Sahajanands Automeck Private Limited H No.504, H road, New Layout, Sonari West, Jamshedpur, Jharkhand, India- 831011		
Date of Registration	25/04/2023	
Title	Street Cleaning Vehicle	
Priority NA		
Design Number	385713-001	
Class	02-04	
M/S A.R.V FOOTWEAR PRIVATE LIMITED C-529, DSIDC INDUSTRIAL PARK, NARELA, DELHI-110040, INDIA		
Date of Registration	08/05/2023	
Title	CLOG	
Priority NA		
Design Number	385301-001	
Class	02-04	
RELAXO FOOTWEARS LIMITED Aggarwal City Square, Plot No. 10, District Centre, Mangalam Place, Sector-03, Rohini, Delhi-110085, India		
Date of Registration	29/04/2023	
Title	Footwear	
Priority NA		


Design Number	384787-001	
Class	02-07	
1.SHATAKSHI AGRAWAL Karnavati University, A/907, Adalaj - Uvarsad Road, Gandhinagar-382422, Gujarat, India 2. SWETA DALAL Karnavati University, A/907, Adalaj - Uvarsad Road, Gandhinagar-382422, Gujarat, India 3. KARNAVATI UNIVERSITY Karnavati University, A/907, Adalaj - Uvarsad Road, Gandhinagar-382422, Gujarat, India		
Date of Registration	26/04/2023	
Title	RUNNER FOR ZIP	
Priority NA		
Design Number	383212-001	
Class	24-02	
1.Dr. Vishwaprakash Roy Professor, PhD Biotechnology, School of Sciences, MATS University, Raipur, 492001 Chhattisgarh, India 2. Prof. Shama Jehan Parveen Khanam Principal, Department of Applied Microbiology and Biotechnology, Ojaswini College par Excellence, Damoh, Madhya Prades, India 3. Mrs. Arpita Mukherjee Assistant Professor, Sai College, Sector-6, Bhilai, 490006 Durg, Chhattisgarh, India 4. Mr. Arpan Dey Assistant Professor, Rungta College of Science and Technology, Durg, Chhattisgarh, India. , et al.		
Date of Registration	06/04/2023	
Title	PETRI PLATE HOLDING DEVICE	
Priority NA		
Design Number	386777-001	
Class	02-03	
S. K. JAIN 49/53 & 49/54, Site-IV, Sahibabad, Ind. Area, Ghaziabad, Uttar Pradesh, India		
Date of Registration	22/05/2023	
Title	Helmet	
Priority NA		

Design Number	384956-001	
Class	15-05	
1.Marwadi University Rajkot – Morbi Highway Road, Gauridad, Rajkot, Gujarat 360003 2. Dr. Gaurang Rajendraprasad Joshi Assistant Professor, Department of Mechanical Engineering, Marwadi University, Rajkot – Morbi Highway Road, Gauridad, Rajkot, Gujarat 3. Jatin Dineshbhai Raiyani Assistant Professor, Department of Automobile Engineering, Marwadi University, Rajkot – Morbi Highway Road, Gauridad, Rajkot, Gujarat		
Date of Registration	26/04/2023	
Title	Remote controlled Solar Panel Cleaning system	
Priority NA		
Design Number	385436-001	
Class	07-99	
1.AMITY UNIVERSITY KOLKATA Major, Arterial Road, AA II, Newtown, Kolkata WEST BENGAL - 700135 2. Dr. Praveen Kumar Maduri Amity University Kolkata, Major, Arterial Road, AA II, Newtown, Kolkata WEST BENGAL 3. Kushagra Singh Amity Global Business School, Sector 125, Noida, Uttar Pradesh 4. Apurva Soni Amity Global Business School, Sector 125, Noida, Uttar Pradesh		
Date of Registration	02/05/2023	
Title	Automatic Plant Watering Device	
Priority NA		
Design Number	382695-001	
Class	12-07	
1.VISTAS Indian Educational and Research Institute, located at, Velan Nagar, P.V. Vaithiyalingam Road, Pallavaram, Chennai – 600117, Tamil Nadu, India. 2. Dr. Arun Raaza Deputy Director R&D, Department of ECE,Vels Institute of Science Technology and Advanced Studies (VISTAS), Velan Nagar, P.V. Vaithiyalingam Road, Pallavaram, Chennai – 600117, Tamil Nadu, India 3. Dr. S. Sivaganesan Associate Professor, Department of Mechanical Engineering, Vels Institute of Science Technology and Advanced Studies (VISTAS), Velan Nagar, P.V. Vaithiyalingam Road, Pallavaram, Chennai – 600117, Tamil Nadu, India.		
Date of Registration	31/03/2023	
Title	SURVEILLANCE DRONE	
Priority NA		


Design Number	388796-001	
Class	12-16	
MATTER MOTOR WORKS PRIVATE LIMITED 301, PARISHRAM BUILDING, 5B RASHMI SOC., NR. MITHAKHALI SIX ROADS, NAVRANGPURA AHMEDABAD, GUJARAT, INDIA - 380009		
Date of Registration	22/06/2023	
Title	RADIATOR GRILLE FOR VEHICLE	
Priority NA		

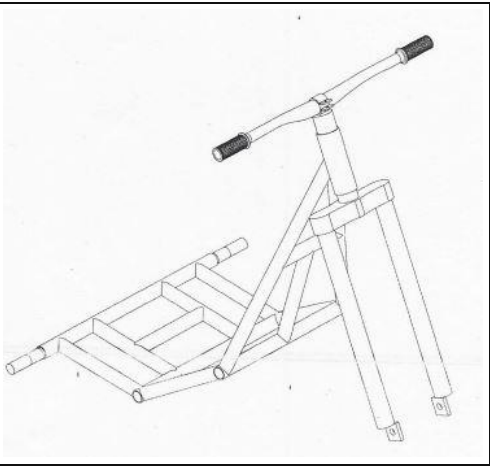
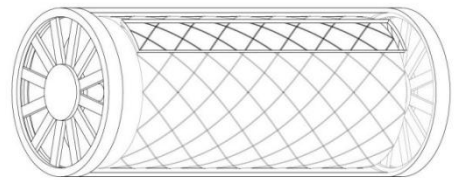

Design Number	385242-001	
Class	20-01	
1.DR. LUBNA NOUSHEEN ASSOCIATE PROFESSOR, DEPT. OF PHARMACEUTICS, ANWARUL ULOOM COLLEGE OF PHARMACY. HYDERABAD. 2. BASHIRA AHMED ASSISTANT PROFESSOR, ANWARUL ULOOM COLLEGE OF PHARMACY. HYDERABAD. 3. MOHAMMED SHOUKHATULLA ANSARI ASSOCIATE PROFESSOR, DEPT OF PHARMACEUTICS ANWARUL ULOOM COLLEGE OF PHARMACY. 4. MOHAMMED ARSHAD KHAN RESEARCH SCHOLAR, DEPARTMENT OF PHARMACY SINGHANIA UNIVERSITY, PACHRI BARI RAJASHTHAN. , et al.		
Date of Registration	28/04/2023	
Title	IOT Based Automated Pill Dispenser	
Priority NA		

Design Number	385849-001	
Class	09-07	
VEDANT PLASTIC C/365, MAHAVIR BAG ODHAV, C.H SOC LTD, ARBUDANAGAR, NR CHHAGANBHAI NO KUVU, ODHAV, AHMEDABAD-382415, GUJARAT, INDIA		
Date of Registration	09/05/2023	
Title	LID FOR CONTAINER	
Priority NA		

Design Number	388110-001	
Class	07-01	
M/s Nayasa Superplast a partnership concern Survey No. 370/2 (7) Kachigam, Nani Daman, Daman- 396 210, (Union Territory of India)		
Date of Registration	10/06/2023	
Title	SET OF BOWLS WITH TRAY	
Priority NA		

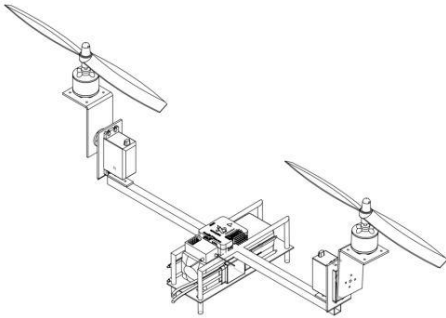
Design Number	387973-001	
Class	11-01	
TEJANI ADESH MANHARBHAI 6, SHUBHLAXMI RAW HOUSE, SINGANPOR ROAD, SURAT, GUJARAT-395004.		
Date of Registration	09/06/2023	
Title	RING	
Priority NA		


Design Number	359212-016	
Class	09-01	
Ms. HBH Polymers H. K. Industries, Survey No. 101/3, Plot No-3, Satda Road, Kuchiyadad-360023 Ta.Dist - Rajkot - 360024 (Gujarat) India		
Date of Registration	23/02/2022	
Title	BOTTLES	
Priority NA		

Design Number	374427-001	
Class	12-11	
VAGAA MOTORS (OPC) PRIVATE LIMITED VILLAGE- KARJAIN, TOLA-KARJAIN, PANCH- KARJAIN BLOCK- RAGHOPUR SUPAUL Supaul BR 852215 IN		
Date of Registration	19/11/2022	
Title	ELECTRIC CYCLE FRAME	
Priority NA		
Design Number	387301-001	
Class	13-01	
1.IIMT UNIVERSITY IIMT University 'O' Pocket, Ganga Nagar Colony, Mawana Road, Meerut, Uttar Pradesh, India 2. DR. DEEPA SHARMA IIMT University 'O' Pocket, Ganga Nagar Colony, Mawana Road, Meerut, Uttar Pradesh, India 3. MR. AKSHAY RAJ IIMT University 'O' Pocket, Ganga Nagar Colony, Mawana Road, Meerut, Uttar Pradesh, India 4. MR. VAIBHAV SHARMA IIMT University 'O' Pocket, Ganga Nagar Colony, Mawana Road, Meerut, Uttar Pradesh, India		
Date of Registration	30/05/2023	
Title	OCEAN THERMAL ENERGY CONVERTER (OTEC) DESALINATION APPARATUS	
Priority NA		
Design Number	387330-001	
Class	08-03	
1.Pawan Rajendra Khodke Department of Structural Engineering, SRES's Sanjivani College of Engineering, Post- Shingnapur, Kopargaon-423603 Tal- Kopargaon. Dist. Ahmednagar State-Maharashtra, India. 2. Divya Ravindra Kshirsagar Department of Structural Engineering, SRES's Sanjivani College of Engineering, Post-Shingnapur, Kopargaon-423603 Tal- Kopargaon. Dist. Ahmednagar State-Maharashtra, India. 3. Sachin Madhavrao Gunjal Department of Structural Engineering, SRES's Sanjivani College of Engineering, Post- Shingnapur, Kopargaon-423603 Tal- Kopargaon. Dist. Ahmednagar State-Maharashtra, India. 4. Sudhir Bhaskarrao Gayake Department of Structural Engineering, SRES's Sanjivani College of Engineering, Post- Shingnapur, Kopargaon-423603 Tal- Kopargaon. Dist. Ahmednagar State-Maharashtra, India.		
Date of Registration	31/05/2023	
Title	Column Plaster Carving Trowel	
Priority NA		


Design Number	388927-001	
Class	22-06	
S.Durairaj S.F.No: 287/1, Pappampatti Road, Kannampalayam Post, Coimbatore - 641 402, Tamilnadu, India		
Date of Registration	23/06/2023	
Title	Mosquito Bat	
Priority NA		
Design Number	383925-001	
Class	12-16	
Ather Energy Private Limited 3rd Floor, Tower D, IBC Knowledge Park, #4/1, Bannerghatta Main Road Bengaluru, Karnataka, India 560029		
Date of Registration	14/04/2023	
Title	Motor Pulley	
Priority NA		
Design Number	388947-001	
Class	13-02	
Luminous Power Technologies Pvt. Ltd. C56, Mayapuri Industrial Area, Phase-II, Mayapuri, New Delhi- 110064		
Date of Registration	23/06/2023	
Title	Battery Rope Handle	
Priority NA		

Design Number	384485-001	
Class	12-07	
COUNCIL OF SCIENTIFIC AND INDUSTRIAL RESEARCH 2, Rafi Marg, New Delhi – 110 001 , India		
Date of Registration	20/04/2023	
Title	DRONE-AIDED WIRELESS AIR SAMPLER	
Priority NA		


Design Number	385070-001	
Class	12-07	
1. Tamil Nadu Agricultural University (TNAU) Tamil Nadu Agricultural University (TNAU), Lawley Road, Coimbatore 641003 2. L. Femiya Tamil Nadu Agricultural University (TNAU), Lawley Road, Coimbatore 641003 3. G. Bhuvaneshwari Tamil Nadu Agricultural University (TNAU), Lawley Road, Coimbatore 641003 4. E. Kalpana Tamil Nadu Agricultural University (TNAU), Lawley Road, Coimbatore 641003 , et al.		
Date of Registration	26/04/2023	
Title	DUAL MOTOR BIRD SCARER DRONE	
Priority NA		

Design Number	388058-001	
Class	24-01	
1. Dr. Duraiswamy Dhachinamoorthi QIS College of Pharmacy, Ongole, Andhra Pradesh - 523272, India 2. Dr. Senthil Prabhu Rajendran M. Pharm., PhD., Assistant Professor, Department of Pharmaceutics, College of Pharmacy, Madurai Medical College, Madurai, Tamil Nadu - 625020, India 3. Dr. Harshad Sunil Kapare M.Pharm PhD, Associate Professor, Department of Pharmaceutics, Dr. D.Y.Patil Institute of Pharmaceutical Sciences and Research, Pimpri, Pune, Maharashtra - 411018, India 4. Dr. Kalpita Bhatta Assistant Professor, Department of Botany, School of Applied Sciences, Centurion University of Technology and Management, Bhubaneswar, Odisha - 752050, India , et al.		
Date of Registration	09/06/2023	
Title	LABORATORY ULTRASONICATOR FOR NANOPARTICLE SYNTHESIS	
Priority NA		


Design Number	341489-001	
Class	14-03	
SAMSUNG ELECTRONICS CO., LTD. 129, Samsung-ro, Yeongtong-gu, Suwon-si, Gyeonggi-do, Republic of Korea		
Date of Registration	25/03/2021	
Title	MOBILE PHONE	
Priority		
Priority Number	Date	Country
30-2021-0003966	26/01/2021	Republic of Korea






Design Number	388400-001	
Class	02-02	
Harpreet Narula Kabbalah, C-66, Sector-4, Noida- 201301, Uttar Pradesh, INDIA		
Date of Registration	15/06/2023	
Title	Garment Set	
Priority NA		

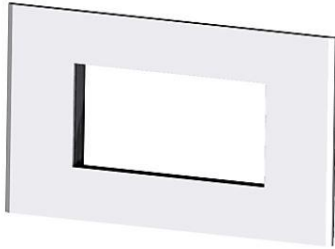


Design Number	383214-001	
Class	24-01	
1. Dr. Nilesh Madhukar Patil Associate Professor, SVKM's Dwarkadas J. Sanghvi College of Engineering, Vile Parle West, Mumbai-400056, Maharashtra, India 2. Dr. Dattatray G. Takale Assistant Professor, VIIT, SPPU, Pune, Maharashtra, India 3. Dr. Vajid N. Khan Associate Professor, KJCOEMR, Pune, Maharashtra, India. 4. Dr. Mohammad Shahid Associate Professor, Head, Noida Institute of Engineering and Technology, Greater Noida, Uttar Pradesh, India. , et al.		
Date of Registration	06/04/2023	
Title	AGING SKIN TREATMENT DEVICE	
Priority NA		




Design Number	388119-001		
Class	15-03		
1.Mr. Bal veer Singh PhD Scholar, Department of Agronomy, Chandra Shekhar Azad University of Agriculture and Technology, Kanpur, Uttar Pradesh-208002, India 2. Mr. Shakti Singh PhD Scholar, Department of Agricultural Biochemistry, Chandra Shekhar Azad University of Agriculture and Technology, Kanpur, Uttar Pradesh-208002, India 3. Dr.Priya Srivastava Assistant Professor, Department of Zoology, St. Xavier's College, Ranchi, Jharkhand- 834001, India 4. Dr.Samikhya Bhuyan Assistant professor, Department of Soil Science and Agricultural Chemistry, Rajiv Gandhi University, Rono Hills Doimukh, Arunachal Pradesh- 791112, India , et al.			
Date of Registration	10/06/2023		
Title	Agricultural Drone for Crop Health Monitoring		
Priority NA			
Design Number	354181-001		
Class	10-05		
Neles Finland Oy Vanha Porvoontie 229 01380 Vantaa Finland			
Date of Registration	02/12/2021		
Title	VALVE CONTROLLER		
Priority			
Priority Number	Date	Country	
008565386	04/06/2021	EUIPO	
Design Number	388913-001		
Class	11-05		
DEEPAK BADARIYA Ground Floor, Regaro Ka Mohalla, Merta City, Nagaur-341510, Rajasthan, India			
Date of Registration	23/06/2023		
Title	DECORATIVE ARTICLE		
Priority NA			


Design Number	383011-001	
Class	23-01	
1. ARPIT KUMAR Bihar Bal Bhawan Kilkari, Campus of Rashtrabhasha, Parisad, Saidpur, Patna-800004, INDIA 2. ABHIJEET KUMAR Bal Bhawan Kilkari, Campus of Rashtrabhasha, Parisad, Saidpur, Patna-800004, INDIA 3. AKSHAT ADARSH Bal Bhawan Kilkari, Campus of Rashtrabhasha, Parisad, Saidpur, Patna-800004, INDIA 4. MD. SADULLAH JAWAID Director, PRANJAL Public Health Engineering Department, Govt of Bihar, # 17 Patliputra, Industrial Area-800012, India		
Date of Registration	04/04/2023	
Title	DOMESTIC WATER FILTER	
Priority NA		
Design Number	352363-001	
Class	14-02	
SHARDA UNIVERSITY PLOT NO. 32, 34, KNOWLEDGE PARK III, GREATER NOIDA, UTTAR PRADESH 201310		
Date of Registration	30/10/2021	
Title	VIRTUAL REALITY CONTROLLER	
Priority NA		
Design Number	386868-001	
Class	26-05	
WIPRO ENTERPRISES PRIVATE LIMITED 'Wipro House', No. 8, 7th Main, 80 Feet Road, Koramangala, 1st Block Bangalore - 560034 , Karnataka, India;		
Date of Registration	23/05/2023	
Title	LIGHTING FIXTURE	
Priority NA		

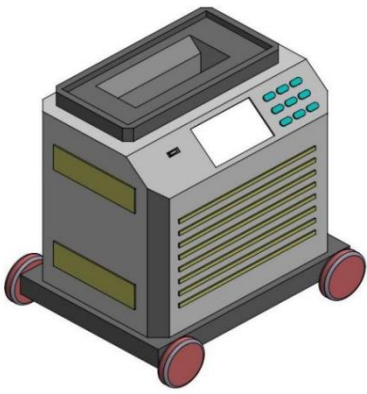
Design Number	387846-001	
Class	13-03	
Vihan Electric Private Limited Plot no 21, Opp Apple studio, Near Burmashell Petrol Pump, Village Valiv, Vasai (East) Dist: Palghar- 401208		
Date of Registration	07/06/2023	
Title	SWITCH PLATE	
Priority NA		

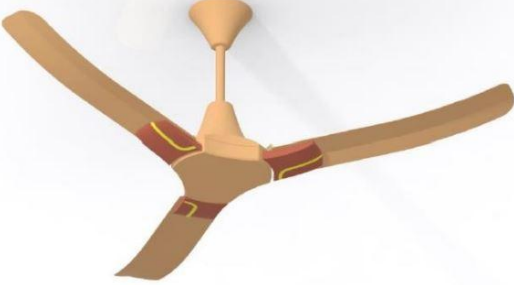
Design Number	385378-001	
Class	02-02	
SABYASACHI CALCUTTA LLP 80/2 Topsia Road (South), Kolkata-700046, West Bengal.		
Date of Registration	29/04/2023	
Title	LADIES GARMENT (SET)	
Priority NA		


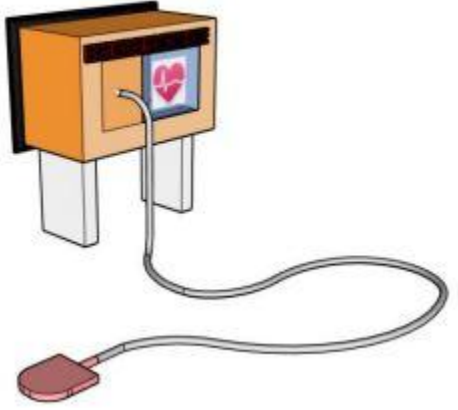
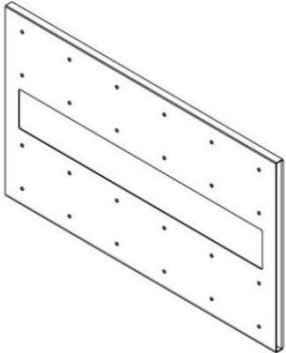
Design Number	388781-001	
Class	08-01	
National Institute of Design Opposite Tagore Hall, Rajnagar Society, Paldi Ahmedabad, Gujarat-380007 India		
Date of Registration	21/06/2023	
Title	DRILLING MACHINE	
Priority NA		

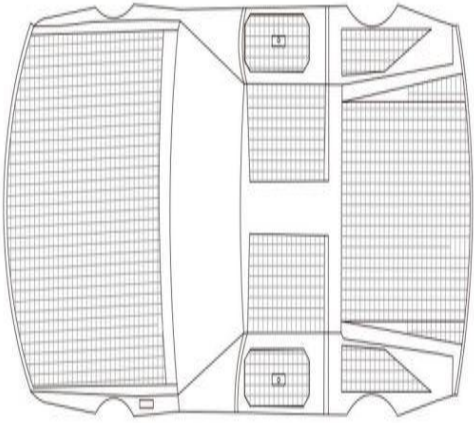

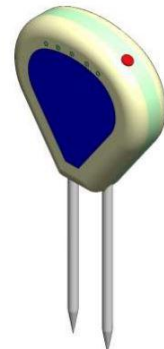
Design Number	388897-001	
Class	10-01	
ABDUL MAJEED K KAMBRATH HOUSE, RANDATHAANI PO, MALAPPURAM, PIN 676510, KERALA, INDIA		
Date of Registration	23/06/2023	
Title	WOODEN CLOCK	
Priority NA		


Design Number	356462-001	
Class	10-02	
1. Dr. M. Mohan Associate Professor, Computer Science & Engineering Department SRM University, Plot No.39, Rajiv Gandhi Education City, P.S. Rai (Post Office), Sonipat, Haryana – 131029 2. Dr. P C Kishoreraja Professor, Electronics and Communication Department SRM University, Plot No.39, Rajiv Gandhi Education City, P.S. Rai (Post Office), Sonipat, Haryana - 131029 3. Dr. R. Sankar Associate Professor, Mechanical Engineering Department SRM University, Plot No.39, Rajiv Gandhi Education City, P.S. Rai (Post Office), Sonipat, Haryana - 131029 4. Dr. Ajay Sharma Professor, Computer Science & Engineering Department SRM University, Plot No.39, Rajiv Gandhi Education City, P.S. Rai (Post Office), Sonipat, Haryana – 131029		
Date of Registration	10/01/2022	
Title	Computer Controlled Wearable Touch Display Device	
Priority NA		




Design Number	388951-001	
Class	09-09	
1. Dr Anupam Das Associate Professor, Department of CSE, The Assam Royal Global University, Betkuchi, Guwahati, Assam, Pin-781033 2. Dr Vaskar Deka Assistant Professor, Department of Information Technology, Gauhati University, Guwahati, Assam, Pin-781034 3. Dr Ishita Chakraborty Assistant Professor, Department of CSE, The Assam Royal Global University, Betkuchi, Guwahati, Assam, Pin-781033 4. Dr Prsmita Sarma Assistant Professor, Department of Information Technology, Gauhati University, Guwahati, Assam, Pin-781034 , et al.		
Date of Registration	23/06/2023	
Title	AN INTELLIGENT SENSOR BASED BIODEGRADABLE WASTE COLLECTION UNIT	
Priority NA		


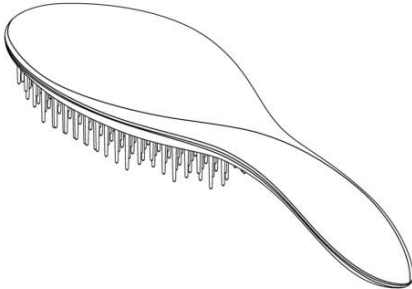

Design Number	388700-001	
Class	23-04	
R R KABEL LIMITED Ram Ratna House, Victoria Mill Compound (Oasis Complex), Pandurang Budhkar Marg, Worli, Mumbai – 400 013, Maharashtra, India,		
Date of Registration	20/06/2023	
Title	CEILING FAN	
Priority NA		
Design Number	387421-001	
Class	23-03	
1. Academy of Maritime Education and Training (AMET) deemed to be university 135, Kanathur East Coast Road, Chennai 603112, Tamilnadu, India 2. S. Jaisankar Department of Mechanical Engineering, AMET University, 135, Kanathur East Coast Road, Chennai-603112 3. J. Ananth Department of Marine Engineering, AMET University, 135, Kanathur East Coast Road, Chennai-603112		
Date of Registration	01/06/2023	
Title	Pentagonal solar leaf collector	
Priority NA		
Design Number	385473-001	
Class	24-99	
1.ISF COLLEGE OF PHARMACY ISF COLLEGE OF PHARMACY, MOGA, PUNJAB, INDIA 2. MAITRAYEE GHOSH Research Scholar, Department of Pharmaceutics, ISF College of Pharmacy, Moga, Punjab 3. DEBAJYOTI ROY RESEARCH SCHOLAR, DEPARTMENT OF PHARMACOGNOSY, ISF COLLEGE OF PHARMACY, MOGA, PUNJAB 4. DR. NARESH KUMAR RANGRA ASSOCIATE PROFESSOR, DEPARTMENT OF PHARMACEUTICAL ANALYSIS, ISF COLLEGE OF PHARMACY, MOGA 142001 , et al.		
Date of Registration	02/05/2023	
Title	NANOFIBRE MAKING DEVICE FOR LABORATORY USE	
Priority NA		



Design Number	385382-001	
Class	23-08	
1. Krunal Prakash Rane “Deepkul” Row H N-08, Karma Park, Near Bhagwant Park, Wadziri Road, Shirpur, Dist-Dhule 425405, MH 2. Deepti Anil Barhate “Deepkul” Row H N-08, Karma Park, Near Bhagwant Park, Wadziri Road, Shirpur, Dist-Dhule 425405, MH 3. Hemraj R Kumavat 05, Nilkanthshwer Nagar, Amode, Tal: Shirpur, Dist: Dhule, MH, 425405 4. Vishal Suresh Bagul 04, Durga Apartment Near Recreation Garden Mandal Shiwar Shirpur, Tal-Shirpur, Dist-Dhule-425405 , et al.		
Date of Registration	01/05/2023	
Title	SANITARY NAPKIN INCINERATOR	
Priority NA		
Design Number	388582-001	
Class	24-02	
1. Dr. P. DILEEP Professor, CSE, Malla Reddy College of Engineering and Technology, Kompally, Hyderabad, Telangana - 500100. 2. Dr. Vinay Saxena Professor, Mathematics, Kisan Post Graduate College, Bahraich, Uttar Pradesh- 271801 3. Dr. ANURAG RAWAT Associate Professor, Himalayan Institute Of Medical Science, Dehradun, Uttarakhand-248140 4. P.REVATHY Assistant Professor, Department of Computer Science and Engineering,, Narsimha Reddy Engineering College, Kompally, Hyderabad, Telangana State- 500100. Telangana , et al.		
Date of Registration	19/06/2023	
Title	HEART DISEASE PREDICTION DEVICE	
Priority NA		
Design Number	383798-001	
Class	10-05	
MANIPAL ACADEMY OF HIGHER EDUCATION Madhav Nagar, Manipal 576104, Karnataka, India,		
Date of Registration	13/04/2023	
Title	TENSILE SAMPLE MOUNT FOR ACCELERATED WEATHERING CHAMBER	
Priority NA		


Design Number	370591-001	
Class	12-08	
BILAL AHMAD MIR H No.2 Sanatnagar Exchange Lane, Near Post Office , Srinagar Kashmir , Pincode 190005		
Date of Registration	09/09/2022	
Title	SOLAR POWERED CAR	
Priority NA		
Design Number	384090-001	
Class	23-04	
Dinesh Kumar Purohit Ka Was Bhawrani, Tahsil, Ahore, Jalore – 343042, Rajasthan, India,		
Date of Registration	17/04/2023	
Title	FAN	
Priority NA		
Design Number	388628-001	
Class	10-05	
1. Dr. Nupur Mistry Associate Professor, Department of Architecture, Anantrao Pawar College of Architecture, Savitribai Phule Pune University, Pune, Maharashtra, India 2. Dr. Gouri Desai Associate Professor, Department of Architecture, Goa College of Architecture, Panjim Government of Goa, India 3. Rajveer Subject Matter Specialist (Soil Science), Krishi Vigyan Kendra, Jaisalmer, Swami Keshwanand Rajasthan Agriculture University, Bikaner, Rajasthan, India 4. Dr. V. Subedha Professor, Department of Computer Science and Engineering, Panimalar Engineering College, Chennai, Tamil Nadu, India , et al.		
Date of Registration	19/06/2023	
Title	SOIL TESTING DEVICE INTEGRATED WITH IOT UNIT	
Priority NA		

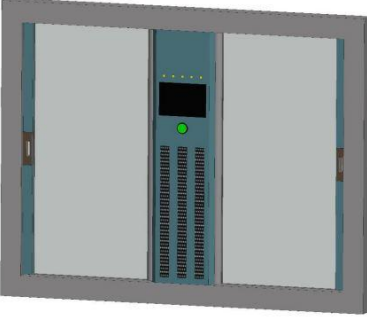
Design Number	388932-001	
Class	07-02	
Hawkins Cookers Limited F 101, Maker Tower, Cuffe Parade, Mumbai (Bombay) 400 005, India.,		
Date of Registration	23/06/2023	
Title	COOKWARE WITH LID (SET)	
Priority NA		
Design Number	388310-001	
Class	11-01	
TITAN COMPANY LIMITED Integrity' No.193, Veerasandra, Electronics City P.O., Off Hosur Main Road, Bangalore – 560100		
Date of Registration	14/06/2023	
Title	JEWELLERY	
Priority NA		
Design Number	345948-001	
Class	12-16	
Mahindra & Mahindra Limited Farm Equipment Sector, Swaraj Division, Phase IV, Industrial Area, S.A.S. Nagar (Mohali)– 160055		
Date of Registration	08/07/2021	
Title	SCUTTLE ASSEMBLY OF A VEHICLE	
Priority NA		


Design Number	384635-001	
Class	02-01	
Ashvin Vishnu Ade A/703, Versova CHSL, Plot-2, S.V.P. Nagar, Mhada, Opp. Telephone Exchange, Andheri West, Azad Nagar, Mumbai, Maharashtra 400053.		
Date of Registration	24/04/2023	
Title	Boxer Brief	
Priority NA		
Design Number	385071-001	
Class	02-02	
SANKET JIVRAJBHAI ANTALA 422, PUJAN PLAZA, NEAR VANMALI JUNCTION, BRTS CANAL ROAD, SURAT		
Date of Registration	26/04/2023	
Title	SAREE AND BLOUSE (SET)	
Priority NA		
Design Number	383786-001	
Class	09-05	
NEHA GUPTA A-141, Sector-63, Noida, Uttar Pradesh-201307, India		
Date of Registration	13/04/2023	
Title	GEL POUCH	
Priority NA		

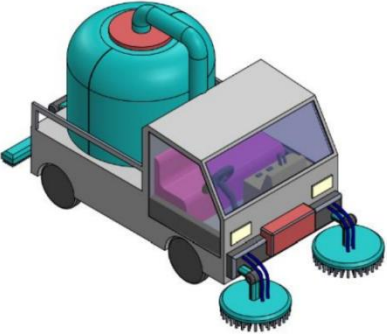
Design Number	388978-001		
Class	02-04		
SABYASACHI CALCUTTA LLP 80/2 Topsia Road (South), Kolkata-700046, West Bengal.			
Date of Registration	24/06/2023		
Title	SHOE (SET)		
Priority NA			
Design Number	388666-001		
Class	04-02		
MTG CO., LTD 2-32 Honjin-tori, Nakamura-ku, Nagoya-shi, Aichi 4530041, Japan			
Date of Registration	19/06/2023		
Title	Hair Brush		
Priority			
Priority Number	Date	Country	
2022-027320	20/12/2022	Japan	
Design Number	384539-001		
Class	09-01		
Prashant Sanjaybhai Jayswal Bhagawati Krupa" Naval Nager street 3/17, Nr.Swami Narayan Chowk, Rajkot - 360004			
Date of Registration	21/04/2023		
Title	Bottle		
Priority NA			


Design Number	385097-001		
Class	13-02		
GUANGDONG OPPO MOBILE TELECOMMUNICATIONS CORP., LTD. No. 18, Haibin Road, Wusha, Chang'an, Dongguan, Guangdong 523860, China			
Date of Registration	27/04/2023		
Title	HEADPHONE CASE		
Priority			
Priority Number	Date	Country	
202230736844.8	04/11/2022	China	
Design Number	384193-001		
Class	28-03		
APTAR PHARMA INDIA PVT. LTD. R-854, TTC Industrial Estate, Thane-Belapur Road, Rabale, Navi Mumbai, Maharashtra 400701, India			
Date of Registration	18/04/2023		
Title	DISPENSER FOR COSMETICS		
Priority NA			
Design Number	385240-001		
Class	24-01		
1. Easari. Parusha Ramu Assistant Professor/ Department of ECE, Sri Indu College of Engineering & Technology (Autonomous), Ibrahimpatnam, R.R. District, Telangana-501510. 2. Deepika Rathod Bhukya Assistant Professor / Department of ECE, Sri Indu College of Engineering & Technology (Autonomous), Ibrahimpatnam, R.R. District, Telangana-501510. 3. Rumandla Anusha Assistant Professor / Department of ECE Sri Indu College of Engineering & Technology (Autonomous), Ibrahimpatnam, R.R. District, Telangana-501510. 4. G Deepthi Assistant Professor / Department of CSE, TKR College of Engineering and Technology, Meerpet, Saroor Nagar, Ranga Reddy, Hyderabad, Telangana-500097. , et al.			
Date of Registration	28/04/2023		
Title	IOT BASED SANITATION CABINET FOR ELECTRONIC DEVICES		
Priority NA			

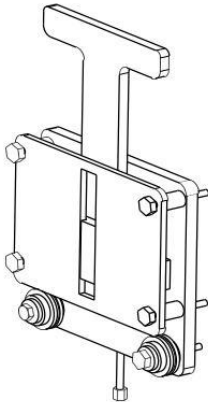
Design Number	387598-001	
Class	14-02	
1.Sarath Chandran MC Assistant Professor, Department of Commerce and Management, Amrita School Of Art's And Science, Amrita Vishwa Vidyapeeth, Amritapuri, Kollam, Kerala- 690525, India 2. Dr. Renju Chandran Assistant Professor, School of Contemporary Knowledge Systems, Chinmaya Vishwa Vidyapeeth (Deemed To Be University), Ernakulam, Kerala, India. 3. Dr. Haritha M Principal, Triveni Group of Institutions, Bangalore, Karnataka, India. 4. Dr. Ravi V Assistant Professor, Department of Professional Studies, Christ University (Deemed to Be University) Yeshwanthpur Campus, Bangalore, Karnataka, India. , et al.		
Date of Registration	04/06/2023	
Title	SMART TAX MANAGING TABLET COMPUTER	
Priority NA		

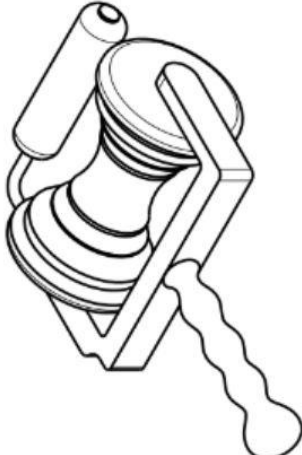

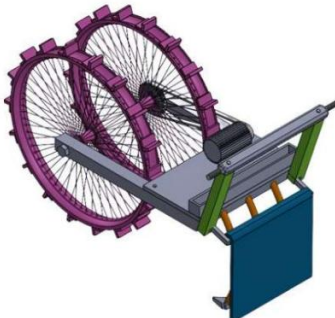
Design Number	387592-001	
Class	10-05	
1.Mr.Abdul Ghaffar S.B.Jain Institute of Technology,Management & Research,Near Jain International School,Yerla Village,Kalmeshwar Road,Nagpur-441501 2. Dr.Sanjay L. Badjate S.B.Jain Institute of Technology,Management & Research,Near Jain International School,Yerla Village,Kalmeshwar Road,Nagpur-441501 3. Nigar Sheikh S.B.Jain Institute of Technology,Management & Research,Near Jain International School,Yerla Village,Kalmeshwar Road,Nagpur-441501 4. Arpita Fusey S.B.Jain Institute of Technology,Management & Research,Near Jain International School,Yerla Village,Kalmeshwar Road,Nagpur-441501 , et al.		
Date of Registration	04/06/2023	
Title	AIR QUALITY DETECTING SMART WINDOW PARTITION	
Priority NA		

Design Number	388077-001	
Class	25-01	
DISHA ECOLOC PAVERS PVT. LTD "Gomati Chhaya", 1, Tilak Nagar, Amravati Road, Nagpur – 440010, Maharashtra		
Date of Registration	10/06/2023	
Title	PAVER	
Priority NA		

Design Number	387875-001	
Class	12-13	
<p>1. Dr. S. KUMARGANESH Professor, Department of ECE, Knowledge Institute of Technology, Salem, Tamil Nadu, India. 2. Dr. P. A. GOWRI SANKAR Associate Professor, Department of EEE, Knowledge Institute of Technology, Salem, Tamilnadu, India. 3. Dr. K. JAYARAM Assistant Professor, Department of ECE, Kalaighnarkaranidhi Institute of Technology, Coimbatore, Tamil Nadu, India. 4. Dr. S. ELANGO Professor, Department of CSE, Madanapalle Institute of Technology & Science Andhra Pradesh, India. , et al.</p>		
Date of Registration	07/06/2023	
Title	IOT BASED STREET CLEANING VEHICLE	
Priority NA		

Design Number	387460-001	
Class	13-01	
<p>1. Dr. Devaanshi Jagwani Associate Professor, Department of Civil Engineering, IPS Academy Institute of Engineering and Sciences Indore, 452012, Madhya Pradesh, India. 2. Dr. Chatrapathy. Kariasappa Professor, School of Computing & Information Technology, Reva University, Kattigenahalli, Bangalore North 560064, Karnataka, India. 3. Dr. Lakhvinder Kaur Associate Professor, Department of Nutrition and Dietetics, Manav Rachna International Institute of Research and Studies, Sector – 43, Aravalli Hills, Delhi – Surajkund Road, Faridabad – 121004, Haryana, India. 4. Dr. R. Suthan Assistant Professor, Department of Mechanical Engineering, Panimalar Engineering College, Poonamallee, Chennai, Thiruvallur 600123, Tamil Nadu, India. , et al.</p>		
Date of Registration	01/06/2023	
Title	DEVICE FOR ELECTRICITY GENERATION FROM WASTE WATER TREATMENT	
Priority NA		

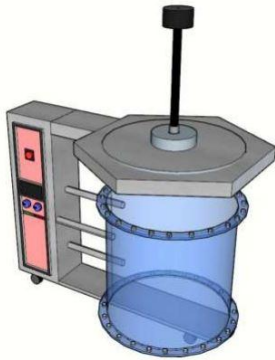


Design Number	385463-001	
Class	12-16	
<p>PRAVAIG DYNAMICS PRIVATE LIMITED B-235, Greater Kailash-1, South Delhi - 110048, Delhi, India</p>		
Date of Registration	02/05/2023	
Title	SLIDER FOR A VEHICLE TAILGATE	
Priority NA		

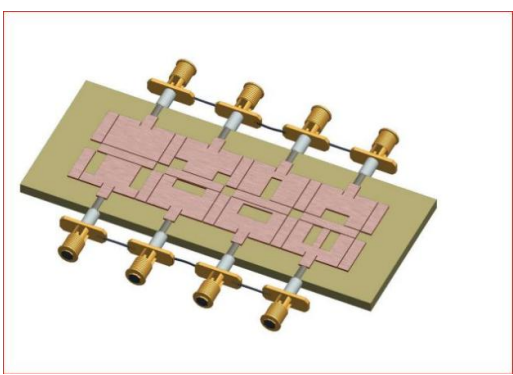
Design Number	388950-001	
Class	04-04	
1. Atul P. Kulkarni BRACIT'S Vishwakarma Institute of Information Technology, Pune.411048 2. Avinash A. Somatkar BRACIT'S Vishwakarma Institute of Information Technology, Pune.411048 3. Radhika R. Kulkarni BRACIT'S Vishwakarma Institute of Information Technology, Pune.411048 4. Mahesh S. Kurulekar BRACIT'S Vishwakarma Institute of Information Technology, Pune.411048 , et al.		
Date of Registration	23/06/2023	
Title	UNIVERSAL ROLLER FOR PAINT	
Priority NA		
Design Number	385421-001	
Class	03-01	
M/s. Chunoba International 14, Jagannath Estate Opp. Gangotri Estate NR. Ring Road, Odhav Ahmedabad- 382415		
Date of Registration	01/05/2023	
Title	SPECTACLE BOX	
Priority NA		
Design Number	385472-001	
Class	15-03	
1. Dr. Ekta Jain SIRTE, Bhopal, M.P., India Pin-462041 2. Prof. Kshitij Yugbodh SISTec-E, Bhopal, M.P., India Pin-462044 3. Shri Vikas Shende MPCST, Vighyan Bhawan, Bhopal, M.P., India Pin-462003 4. Dr. Santosh Sanodiya SIRT, Bhopal, M.P., India Pin-462041 , et al.		
Date of Registration	02/05/2023	
Title	Tillage cum Seed Sowing Machine	
Priority NA		

Design Number	384271-001		
Class	29-02		
DEZEGA SAFETY SOLUTIONS LTD 411 Oxford Street, Office 1.01, London, W1C 2PE			
Date of Registration	19/04/2023		
Title	CARTRIDGE FOR SELF-CONTAINED BREATHING APPARATUS		
Priority			
Priority Number	Date	Country	
6238203	20/10/2022	U.K.	
Design Number	387061-001		
Class	14-02		
1. Dr. Raja Varma Pamba Assistant Professor, Dept of CSE, LBS Institute of Technology for Women, Poojapura, Trivandrum, Kerala 2. Dr. Chaitanya Kulkarni Vidya Pratishthan's Kamalnayan Bajaj Institute of Engineering and Technology, Baramati, Maharashtra 3. Dr. Shyam Akashe Professor, Electronics & Communication Engineering, Department and Dean of International Cooperation & Projects at ITM University, Gwalior, Madhya Pradesh 4. Dr. Sheshang Degadwala Associate Professor, Sigma Institute of Engineering, Engineering Block, Sigma Group of Institutes, Ajwa-Nimeta Road, Bakrol, Vadodara, Gujarat - 390019 , et al.			
Date of Registration	25/05/2023		
Title	IOT enabled audio player integrated printer		
Priority NA			
Design Number	389050-001		
Class	24-02		
1. Dr. R. Saravanan Professor and Head, Department of Pharmaceutics, Faculty of pharmacy, Bharath institute of Higher education and Research, Selaiyur, Tambaram, Chennai-73, Tamil Nadu, India. 2. Dr. Naidu Narapusetty Principal, Bellamkonda Institute Of Technology And Science, Podili-523240, Prakasam-Dt, Andhrapradesh, India. 3. Mrs. Venkata Jhansipriya Marabathuni Associate Professor, Bellamkonda Institute Of Technology And Science, Podili -523245, India. 4. Mrs. Sk. Meharaj Associate Professor, Bellamkonda Institute Of Technology And Science, Podili -523245, India. , et al.			
Date of Registration	26/06/2023		
Title	DISINFECTION CHAMBER FOR COVID 19		
Priority NA			


Design Number	388990-001	
Class	14-02	
1.Suyog Dixit E-3130, Sudama Nagar, Indore, MP, India, Pin: 452009 2. Dr.U .Pavani Associate professor & Head, Department of pharmaceuticals, Nethaji institute of pharmaceutical sciences, Kazipet, Hanamkonda, Telangana, India - 506001 3. Mrs. Swati Prakash Jagtap Pimpri Chinchwad College of Engineering, Nigdi, Pune, Maharashtra 4. Mrs.Archana Vishal Bhamare Pimpri Chinchwad College of Engineering, Nigdi, Pune, Maharashtra , et al.		
Date of Registration	24/06/2023	
Title	MACHINE LEARNING BASED HUMANOID DEVICE FOR OBJECT IDENTIFICATION	
Priority NA		
Design Number	385476-001	
Class	02-02	
1.Graphic Era Hill University, Dehradun Campus 510, Society Area, Clement Town, Dehradun – 248002, Uttarakhand, India. 2. Graphic Era Deemed to be University, Dehradun Bell Road, Clement Town Dehradun, Uttarakhand, 248002, India. 3. Ms. Shristha Bhandari Assistant Professor, Department of Design (Fashion Design). 4. Prof. Jyoti Chhabra Dean School of Design, Department of Design (Fashion Design).		
Date of Registration	02/05/2023	
Title	Draped Executive Top	
Priority NA		
Design Number	386529-001	
Class	22-06	
1.Shri Shankracharya Institute Of Professional Management and Technology, Raipur Old Dhamtari Road, Sejabahar, Mujgahan, Raipur 492015, Chhattisgarh India 2. Dr. R.S. Dhundhel Associate Professor, Department of Chemistry, Shri Shankaracharya Institute of Professional Management and Technology, Raipur-492015, Chhattisgarh, India 3. Dr. V. K. Soni Assistant Professor, Department of Chemistry, Shri Shankaracharya Institute of Professional Management and Technology, Raipur-492015, Chhattisgarh, India 4. Dr. Radhika Sharma Assistant Professor, Department of Chemistry, Shri Shankaracharya Institute of Professional Studies, Raipur 492015, Chhattisgarh, India , et al.		
Date of Registration	18/05/2023	
Title	PEST CONTROL DEVICE WITH REMOTE OPERATION	
Priority NA		

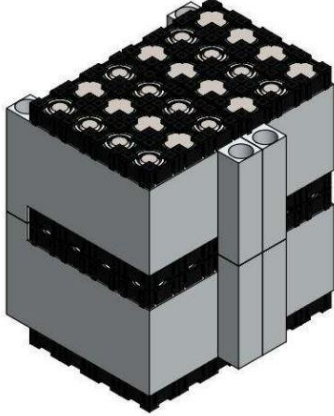
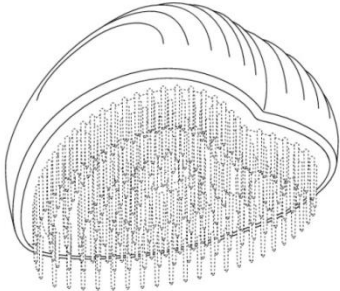
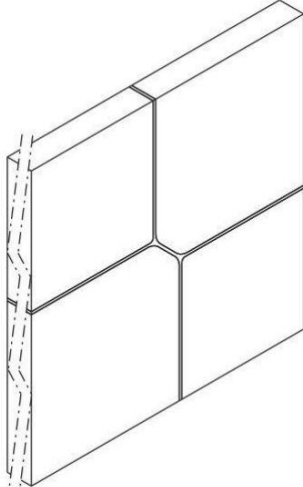
Design Number	384325-001		
Class	29-02		
1. Dr. Prajakta Ajay Khadkikar Assistant Professor, Pune Institute of Computer Technology, Pune 2. Dr. Rupali Atul Mahajan Associate Professor, Vishwakarma Institute of Information Technology, Pune 3. Dr. Kirti Wanjale Associate Professor, Vishwakarma Institute of Information Technology, Pune 4. Dr. Abhijit V. Chitre Associate Professor, Vishwakarma Institute of Information Technology, Pune , et al.			
Date of Registration	19/04/2023		
Title	Smart Wearable Harness		
Priority NA			
Design Number	343145-001		
Class	14-02		
Bloomberg Finance L.P. 731 Lexington Avenue, New York NY 10022, United States			
Date of Registration	07/05/2021		
Title	KEYBOARD		
Priority			
Priority Number	Date	Country	
29/762,958	18/12/2020	U.S.A.	
Design Number	388943-001		
Class	03-03		
1. GOVERNMENT POLYTECHNIC, AHMEDABAD NEAR PANJARAPOL CROSS ROAD, AMBAWADI, AHMEDABAD, GUJARAT- 380015, INDIA 2. YASHVI SHAH NEAR PANJARAPOL CROSS ROAD, AMBAWADI, AHMEDABAD, GUJARAT- 380015, INDIA 3. BRIJESH PATEL NEAR PANJARAPOL CROSS ROAD, AMBAWADI, AHMEDABAD, GUJARAT- 380015, INDIA 4. FALGUNI PATEL NEAR PANJARAPOL CROSS ROAD, AMBAWADI, AHMEDABAD, GUJARAT- 380015, INDIA , et al.			
Date of Registration	23/06/2023		
Title	IOT ENABLED WALKING STICK FOR BLINDS		
Priority NA			




Design Number	385387-001	
Class	28-99	
1. Dr. Mohit Chaturvedi Professor, School of Pharmacy, Dr. A.P.J. Abdul Kalam University, Indore (Madhya Pradesh. Pin code- 452016. 2. Mrs. Anuradha B.Sakhare Assistant Professor, B.R.Harne College of Pharmacy, Vangani. Mumbai University, Thane, Maharashtra. Pin code- 421503. 3. Mr. Neeraj Bhandari Head of Department, Arni School of Pharmacy, Arni University, Kathgarh, Indora, Kangra, Himachal Pradesh. Pin code-176401. 4. Mr. Yogesh Tiwari Research Scholar School of Pharmacy, ITM University, Gwalior, Madhya Pradesh. Pin code- 475001. , et al.		
Date of Registration	01/05/2023	
Title	Mobile 3 Phase Stirrer Machine for Pharma Industry	
Priority NA		
Design Number	350719-010	
Class	15-09	
Endico Power Tools (India) 1266, 1268/A, 1276/1, Streetb No.3, Shimlapuri, Ludhiana-141003, (Punjab), India, Partners are Mr. Avtar Singh, Mr. Jatinder Singh & Mr. Gurjeet Singh		
Date of Registration	05/10/2021	
Title	Y-GUIDE FOR ROUTER MACHINE	
Priority NA		
Design Number	383998-001	
Class	16-06	
1. Dr. T. ASHA Professor & HoD, Department of Information Science & Engineering, Bangalore Institute of Technology, K R Road, V Vpura, Bangalore-560004, Karnataka, India. 2. Dr.B. S. MAYA Assistant Professor, Department of Computer Science & Engineering, Bangalore Institute of Technology, K R Road, V Vpura, Bangalore-560004, Karnataka, India. 3. Dr.N. SHOBHA Associate Professor, Department of Computer Science & Design, Dayananda Sagar College of Engineering, Shavige Malleshwara Hills, Kumaraswamy Layout, Bangalore-560078, Karnataka, India 4. Dr. K. J.BHANUSHREE Associate Professor, Department of Computer Science & Engineering, Bangalore Institute of Technology, K R Road, V Vpura, Bangalore-560004, Karnataka, India. , et al.		
Date of Registration	15/04/2023	
Title	AUGMENTED REALITY GLASSES FOR SKIN CANCER CLASSIFICATION	
Priority NA		

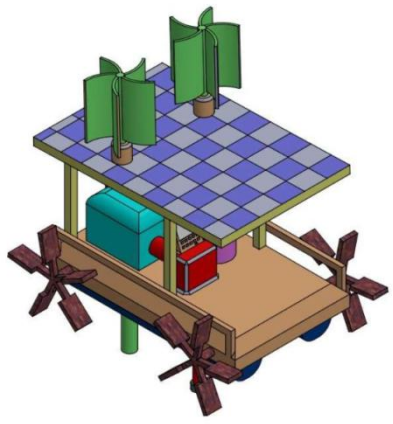
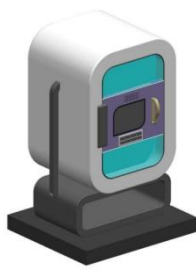
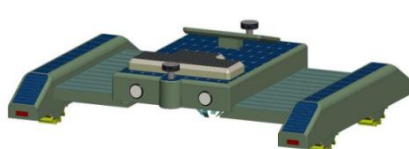
Design Number	388415-001	
Class	14-03	
1. Walchand College of Engineering Sangli - Miraj Rd, Vishrambag, Sangli, Maharashtra 416415 2. Ruikar Sachin Deorao Department of Electronics Engineering, Walchand College of Engineering Sangli, 416415 3. Sarade Shrenik Suresh Department of Electronics Engineering, Walchand College of Engineering Sangli, 416415		
Date of Registration	15/06/2023	
Title	MULTIBAND MIMO ANTENNA	
Priority NA		



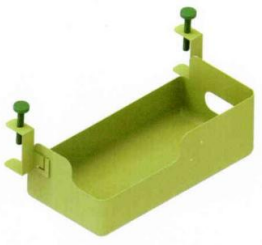
Design Number	385413-001	
Class	02-02	
SABYASACHI CALCUTTA LLP 80/2 Topsia Road (South), Kolkata-700046, West Bengal.		
Date of Registration	01/05/2023	
Title	LADIES GARMENT	
Priority NA		


Design Number	388896-001	
Class	24-01	
SURESH CHAND House No. 2, Kesto Residency, sector-6, Janakipuram Extension, Near Kendriya Vihar, Lucknow - 226031, Uttar Pradesh, India		
Date of Registration	23/06/2023	
Title	Universal Paediatric Spica Table	
Priority NA		


Design Number	386144-001		
Class	23-99		
1.SARDAR VALLABHBHAI NATIONAL INSTITUTE OF TECHNOLOGY Surat-395007 Gujarat, India. 2. Dr. Hemantkumar B Mehta Associate Professor, Department of Mechanical Engineering SVNIT, Surat-7, Gujarat, India. 3. Dr. Vipul M Patel Assistant Professor, Department of Mechanical Engineering, SVNIT, Surat-7, Gujarat, India. 4. Dr. Kalpak Ramakant Sagar A/P Hanmantwadi (ABK), TQ-Nilanga, Dist-Latur, Maharashtra-413521, India. , et al.			
Date of Registration	13/05/2023		
Title	STACKED BATTERY MODULE HOLDER FOR THERMAL MANAGEMENT		
Priority NA			
Design Number	388852-001		
Class	04-02		
MTG CO., LTD. 2-32 Honjin-tori, Nakamura-ku, Nagoya-shi, Aichi, 4530041, Japan			
Date of Registration	22/06/2023		
Title	Hair Brush		
Priority			
Priority Number	Date	Country	
2022-027695	23/12/2022	Japan	
Design Number	384618-001		
Class	14-01		
Osiviso Limited Cirrus House, Glebe Road, Huntingdon, Cambridgeshire, PE29 7DL, United Kingdom			
Date of Registration	24/04/2023		
Title	KEYPAD FOR SPEAKERS		
Priority			
Priority Number	Date	Country	
6239239	25/10/2022	U.K.	


Design Number	384896-001	
Class	31-00	
1.NANDNI MENDPARA Karnavati University, A/907, Adalaj - Uvarsad Road, Gandhinagar-382422, Gujarat, India 2. ARUNITA PAUL Karnavati University, A/907, Adalaj - Uvarsad Road, Gandhinagar-382422, Gujarat, India 3. KARNAVATI UNIVERSITY Karnavati University, A/907, Adalaj - Uvarsad Road, Gandhinagar-382422, Gujarat, India		
Date of Registration	26/04/2023	
Title	DOSA MAKING DEVICE	
Priority NA		
Design Number	388995-001	
Class	20-01	
1.Dr. R. SENTHIL KUMAR ASSOCIATE PROFESSOR, COMPUTER SCIENCE AND ENGINEERING, SHREE VENKATESHWARA HI-TECH ENGINEERING COLLEGE, GOBI, TAMILNADU-638455 2. Dr. S. GOKULRAJ ASSOCIATE PROFESSOR, COMPUTER SCIENCE AND ENGINEERING, VELALAR COLLEGE OF ENGINEERING AND TECHNOLOGY, ERODE, TAMILNADU-638455 3. Dr. S. KAYALVILI ASSOCIATE PROFESSOR, ARTIFICIAL INTELLIGENCE, KONGU ENGINEERING COLLEGE, ERODE, TAMILNADU-638060 4. Mr. J. SENTHIL ASSISTANT PROFESSOR, M.Tech COMPUTER SCIENCE AND ENGINEERING, SRI KRISHNA COLLEGE OF ENGINEERING AND TECHNOLOGY, COIMBATORE, TAMIL NADU-641008 , et al.		
Date of Registration	24/06/2023	
Title	SMART TABLET VENDING MACHINE	
Priority NA		
Design Number	388994-001	
Class	24-02	
1.Dr.PRAMOD SINGH KUNWAR School of Pharmacy, Mount Kenya University, Thika, Kiambu, Kenya - 01000 2. Dr. ABDULRAHIM YUSUF MITHWANI School of Pharmacy, Mount Kenya University, Thika, Kiambu, Kenya - 01000 3. Dr. S P SUBASHINI Dean , Nursing , Galgotias School of Nursing, Galgotias University , Gautham Budha Nagar, Uttar Pradesh - 201301 4. Mr.D.BALAKRISHNAN Assistant Professor ,Department of Computer Science and Engineering , Kalasalingam Academy of Research and Education , Krishnankoil,Srivilliputhur, Tamilnadu 626126 , et al.		
Date of Registration	24/06/2023	
Title	Lung Cancer Testing Device	
Priority NA		

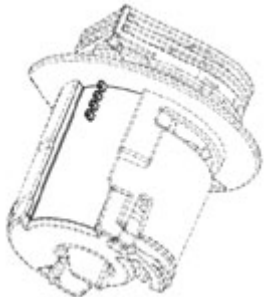
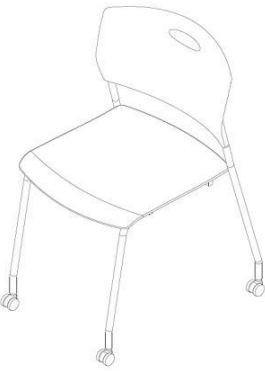

Design Number	388056-001	
Class	15-99	
1.Senthil Kumar Subramanian Pillay Secretary E.G.S Pillay Group of Institution Old Nagore Road Thethi Nagapattinam 611002 T.N 2. Dr. Mohan Veerasamy Prof. Dept .of EEE, E.G.S. Pillay Engineering College Nagapattinam 611002,T.N 3. Dr. Manoj Kumar Mishra Head IPR- Cell E.G.S Pillay Group of HOUSE NO.-13 NSR PILLAY STREET NEAR SUN SUPER MARKET KARAIKAL609602, Puducherry, PIN:609602 4. Dr. Chitrakala Ganapathi Principal Frendenberg Training Center Nagapattinam-611001 , et al.		
Date of Registration	09/06/2023	
Title	IOT BASED HYBRID (WIND AND SOLAR) POWERED AERATOR FOR AQUACULTURE	
Priority NA		
Design Number	387968-001	
Class	15-07	
1.Dr. Kapil Aggarwal Associate Professor, Department of Computer Science & Engineering Koneru Lakshmaiah Education Found 2. Dr. B. Bhaskar Reddy Professor, Department of ECE, St. Peters Engineering College Dhulapally, Maisammaguda Medchal, Hyderabad, Telangana, India, 500100 3. Dr. Sugandha Singh Professor, AI&ML Department, Chaitanya Bharathi Institute of Technology, Hyderabad, Telangana, India, 500075 4. Ms. S. Jayachitra Assistant Professor, Department of Electronics and communication Engineering, PSNA College of Engineering and Technology, Dindigul, Tamil Nadu, India, 624622		
Date of Registration	09/06/2023	
Title	IOT BASED SMART MEDICAL REFRIGERATOR FOR PHARMACEUTICAL STORAGE	
Priority NA		
Design Number	387602-001	
Class	15-03	
1.DKTE Society's Textile and Engineering Institute Rajwada, Ichalkaranji, Maharashtra 416115 2. Mr. Pruthviraj Pravin banne Computer Science and Engineering Department, DKTE's Textile and Engineering Institute, Ichalkartnji, Maharashtra, India 3. Prof. Vivek Vijay Kheradkar Computer Science and Engineering Department, DKTE's Textile and Engineering Institute, Ichalkartnji, Maharashtra, India		
Date of Registration	04/06/2023	
Title	WEED REMOVAL MACHINE	
Priority NA		


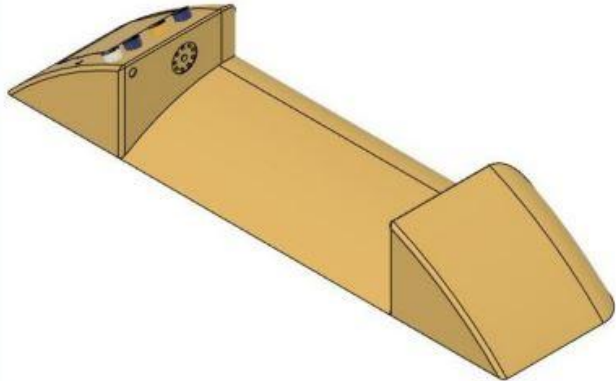
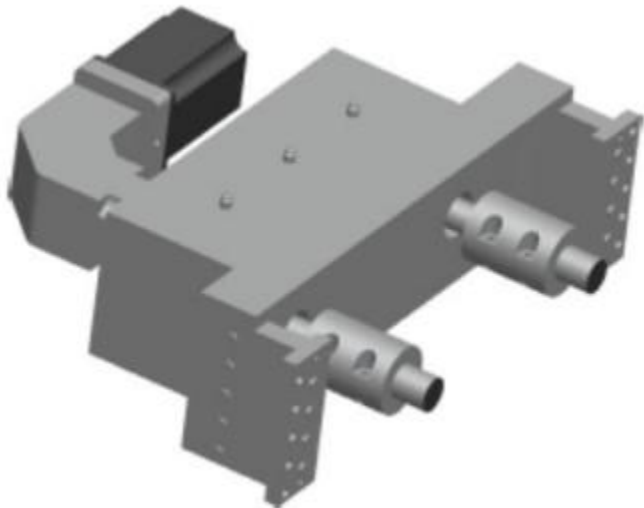
Design Number	387461-001	
Class	10-05	
1.K. Manojkumar Associate Professor, Department of Computer Science and Engineering, Government College of Engineering, Sengipatti, Thanjavur 613402, Tamilnadu, India. 2. Sowmia K R Assistant Professor, Department of AIML, Rajalakshmi Engineering College, Thandalam, Chennai, Kanchipuram 602105, Tamilnadu, India. 3. Dr. A.Kadirvel Professor, Department of Mechanical Engineering, R.M.K. Engineering College, RSM Nagar, Kavaraipettai, Chennai, Thiruvallur District, 601206, Tamilnadu, India. 4. Vidya Sagar Reddy G Associate Professor, School of Architecture, Koneru Lakshmaiah Educational Foundation, Green Fields, Vaddeswaram, Guntur 522502, Andhra Pradesh, India. , et al.		
Date of Registration	01/06/2023	
Title	A Bluetooth device for safe entry and exit	
Priority NA		
Design Number	384930-001	
Class	07-02	
1.VAIBHAV KUSHWAHA Karnavati University, A/907, Adalaj - Uvarsad Road, Gandhinagar-382422, Gujarat, India 2. AAYUSH JAIN Karnavati University, A/907, Adalaj - Uvarsad Road, Gandhinagar-382422, Gujarat, India 3. HITANSHI PANCHAL Karnavati University, A/907, Adalaj - Uvarsad Road, Gandhinagar-382422, Gujarat, India 4. VEDANT SAXENA Karnavati University, A/907, Adalaj - Uvarsad Road, Gandhinagar-382422, Gujarat, India , et al.		
Date of Registration	26/04/2023	
Title	INDUCTION HEATER	
Priority NA		
Design Number	385453-001	
Class	09-09	
CEPT UNIVERSITY KASTURBHAI LALBHAI CAMPUS, UNIVERSITY ROAD, NAVRANGPURA, AHMEDABAD-380009, GUJARAT STATE, INDIA		
Date of Registration	02/05/2023	
Title	WASTE COLLECTOR BIN	
Priority NA		

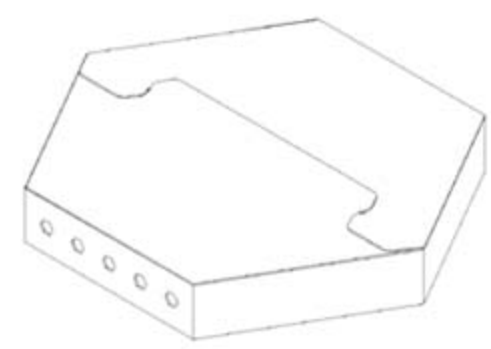
Design Number	385940-004	
Class	06-04	
NILKAMAL LIMITED SURVEY NO-354/2 & 354/3, NEAR RAKHOLI BRIDGE, SILVASSA-KHANVEL ROAD, VILLAGE VASONA, SILVASSA (D & N.H) (U.T), INDIA		
Date of Registration	10/05/2023	
Title	CABINET	
Priority NA		

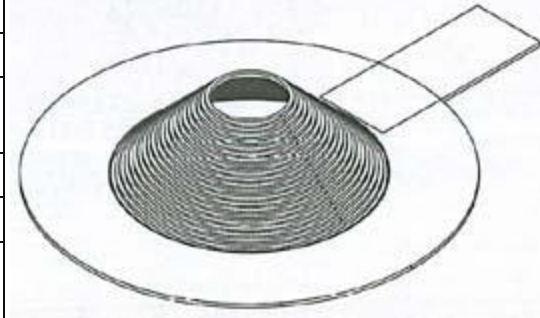
Design Number	377812-001	
Class	24-01	
1. Dr. Padmaja Santosh Kore P. E. Society's Modern College of Pharmacy, Pune Sector 21, Yamunanagar, Nigdi, Pune – 411044, Maharashtra 2. Dr. Ujwala Shivaji Desai P. E. Society's Modern College of Pharmacy, Pune Sector 21, Yamunanagar, Nigdi, Pune – 411044, Maharashtra 3. Dr. Praveen Digambar Chaudhari P. E. Society's Modern College of Pharmacy, Pune Sector 21, Yamunanagar, Nigdi, Pune – 411044, Maharashtra 4. P. E. Society's Modern College of Pharmacy, Nigdi, Pune P. E. Society's Modern College of Pharmacy, Pune Sector 21, Yamunanagar, Nigdi, Pune – 411044, Maharashtra		
Date of Registration	23/01/2023	
Title	INSULIN PEN	
Priority NA		

Design Number	359873-001	
Class	09-03	
Mukesh Jeshabhai Bambhaniya 201, FLOOR-GRD, PLOT-29, RUSTOM BUILDING, VEER NARIMAN ROAD, HUTATMA CHOWK, FORT, MUMBAI-400001, INDIA		
Date of Registration	04/03/2022	
Title	Container Box for cosmetics	
Priority NA		

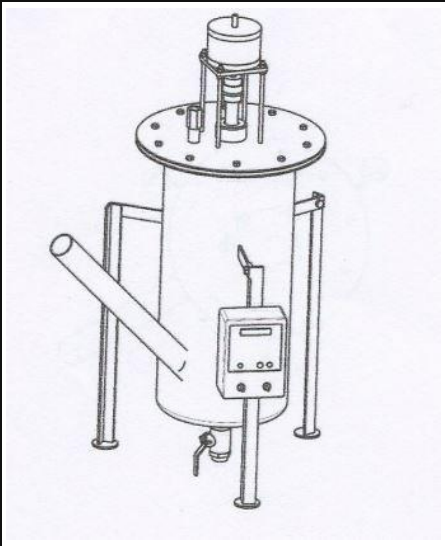
Design Number	359628-001		
Class	14-02		
CANON KABUSHIKI KAISHA a Japanese corporation of 30-2, Shimomaruko 3-chome, Ohta-ku, Tokyo, Japan.			
Date of Registration	01/03/2022		
Title	SUPPLYING PORT MEMBER FOR TONER PACK		
Priority			
Priority Number	Date	Country	
2021-027088	09/12/2021	Japan	
Design Number	387314-001		
Class	06-01		
Wipro Enterprises Private Limited 'Wipro House', No.08, 7th Main, 80 Feet Road, Koramangala 1st Block, Bangalore 560034			
Date of Registration	30/05/2023		
Title	CHAIR		
Priority NA			
Design Number	385394-001		
Class	02-02		
SABYASACHI CALCUTTA LLP 80/2 Topsia Road (South), Kolkata-700046, West Bengal.			
Date of Registration	01/05/2023		
Title	GARMENT		
Priority NA			

Design Number	388541-001	
Class	02-04	
EUPHORIC INNOVATIONS PRIVATE LIMITED Plot No.10-12,SIDCO industrial Estate,Malumichampatti,Coimbatore - 641050		
Date of Registration	17/06/2023	
Title	FOOTWEAR	
Priority NA		
Design Number	388080-001	
Class	06-09	
1.Dr.Nagagopiraju Vullam Professor, Department of Computer Science and Engineering, CHALAPATHI INSTITUTE OF ENGINEERING AND TECHNOLOGY, GUNTUR,Andhra Pradesh. 2. Ramya Asalatha Busi Asst.Professor, Department of Computer Science and Engineering, Vasireddy Venkatadri Institute and Technology, Nambur,GUNTUR,522508 3. Dr. P Balamuralikrishna Dean R&D, Chalapathi Institute of Technology (Autonomous), Mothadaka, Guntur -522016 Andhra Pradesh 4. Ongole Gandhi Assistant Professor Vignan' s Foundation for Science,Technology & Research, Guntur, Andhra Pradesh , et al.		
Date of Registration	10/06/2023	
Title	Electronic Pillow	
Priority NA		
Design Number	385825-001	
Class	15-06	
G RADHAKRISHNAN SHRUTHI ARCADE, AYASAMY NAGAR, AVINASHI ROAD, COIMBATORE , 641 062.		
Date of Registration	09/05/2023	
Title	SLUB GEAR BOX VARIATOR'	
Priority NA		

Design Number	358571-001	
Class	09-03	
Elephant Design Private Limited 13 Kumar Srushti, S.No. 1, NDA-Pashan Road, Bavdhan, Pune 411021 Maharashtra, India		
Date of Registration	15/02/2022	
Title	PACKAGING BOX	
Priority NA		

Design Number	359863-003	
Class	10-04	
Nitaben Natvarbhai Gajjar J3, Kalptaru Flats, Opp. Ganesh Vidhyalaya, Navavadaj, Ahmedabad, 380013, India		
Date of Registration	04/03/2022	
Title	FLOW METER	
Priority NA		

Design Number	389001-001	
Class	10-04	
1. Dr. Mohammad Ahsan Assistant Professor, School of Computer Science, University of Petroleum and Energy Studies, Dehradun, Uttarakhand, India. 2. Dr. Bam Bahadur Sinha Assistant Professor, Indian Institute of Information Technology Ranchi, Jharkhand, India.		
Date of Registration	25/06/2023	
Title	Machine Learning based Stress Detection Device	
Priority NA		

Design Number	384367-001	
Class	15-99	
1.New Gen IEDC, College of Technology and Engineering College of Technology and Engineering, Udaipur, Rajasthan, India - 313001 2. Narayan Lal Panwar Department of Renewable Energy Engineering, Maharana Pratap University of Agriculture and Technology, Udaipur, Rajasthan, India - 313001 3. Dr. Chitranjan Agarwal Department of Renewable Energy Engineering, Maharana Pratap University of Agriculture and Technology, Udaipur, Rajasthan, India - 313001 4. Rupal Jain Department of Renewable Energy Engineering, Maharana Pratap University of Agriculture and Technology, Udaipur, Rajasthan, India - 313001 , et al.		
Date of Registration	20/04/2023	
Title	Dark fermenter for bio hydrogen production	
Priority NA		


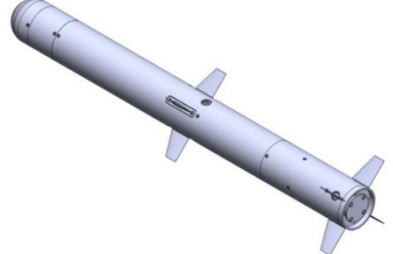

Design Number	380252-001	
Class	12-11	
HONDA MOTOR CO., LTD. 1-1, Minami-Aoyama 2-Chome, Minato-ku, Tokyo, 107-8556 Japan		
Date of Registration	27/02/2023	
Title	Front Cover for a motor scooter	
Priority		
Priority Number	Date	Country
2022-018771	01/09/2022	Japan





Design Number	385287-001
Class	14-02
1.Ms. Babita H. Kakkar Assistant Professor, Department of B.Com.(FM), SIES (Nerul) College of Arts, Science and Commerce, University of Mumbai 400706 2. Dr. Rajeshri Pravin Shinkar Assistant Professor, Department of Computer Science, SIES (Nerul) College of Arts, Science & Commerce, University of Mumbai 400706 3. Dr. Sheeja Ravi Assistant Professor, Department of Mathematics and Statistics, SIES (Nerul) College of Arts, Science & Commerce, University of Mumbai, Maharashtra, India. 4. Dr. T. Samson Joe Dhinakaran Assistant Professor In Commerce, St. John's College, Palayamkottai, Tirunelveli, Tamil Nadu,627002 India , et al.	
Date of Registration	29/04/2023
Title	EMPLOYEE BOREDOM TRACKING AND AMUSEMENT DEVICE
Priority NA	


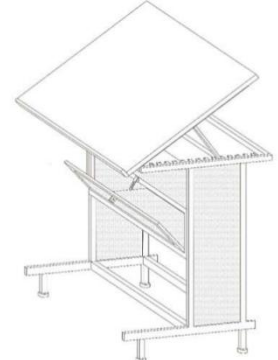




Design Number	344224-002		
Class	24-02		
Omron Healthcare Co., Ltd. 53, Kunotsubo, Terado-cho, Muko-shi, Kyoto 617-0002, Japan			
Date of Registration	02/06/2021		
Title	ATOMIZER MOUTHPIECE FOR INHALER		
Priority			
Priority Number	Date	Country	
JP 2020-025969	02/12/2020	Japan	
Design Number	388661-001		
Class	20-01		
1.Puja Gholap Assistant Professor, Department of Computer Engineering, Sharadchandra Pawar College of Engineering,Otur, Pune, Maharashtra, India. 2. Dr. Vishwajit Bhagwat Assistant Professor, Automobile Engineering Department, Dhole Patil College of Engineering Pune, Affiliated to Savitribai Phule Pune University, Near Eon IT Park Kharadi Pune -412207, Maharashtra, India 3. Dr. K.V.S.Prasad Associate Professor, Basic Sciences and Humanities Department, GMR Institute of Technology, GMR Nagar, Rajam -532 127, Vizianagaram District, Andhra Pradesh, India 4. Ezekiel Jebaraj Solomon Sr.Manager, Cybersecurity Engineering, Cybersecurity Comcast India Engineering Center, Chennai One SEZ, 5th Floor, North Block in Phase II Module 7& 8, 200 Feet Radial Rd, Thoraipakkam, Chennai –600097,Kanchipuram, Tamil Nadu, India , et al.			
Date of Registration	19/06/2023		
Title	IOT BASED AUTOMATED PILLS DISPENSER		
Priority NA			
Design Number	384886-001		
Class	21-01		
1.NITI SHAH Karnavati University, A/907, Adalaj - Uvarsad Road, Gandhinagar-382422, Gujarat, India 2. TRISHA PILLAI Karnavati University, A/907, Adalaj - Uvarsad Road, Gandhinagar-382422, Gujarat, India 3. SHRAY VORA Karnavati University, A/907, Adalaj - Uvarsad Road, Gandhinagar-382422, Gujarat, India 4. ASHISH SONI Karnavati University, A/907, Adalaj - Uvarsad Road, Gandhinagar-382422, Gujarat, India , et al.			
Date of Registration	26/04/2023		
Title	GAMEPAD		
Priority NA			

Design Number	388902-001	
Class	14-02	
1. Dr. Dipti Baghel Assistant Professor, Commerce Department, Dr. Khubchand Baghel Govt. PG College Bhilai-3 Chhattisgarh-490025, India 2. Dr. Archi Dubey Assistant Professor, Faculty of Management Studies, The ICFAI University Raipur, Raipur-Bhilai Road, Kumhari, Durg, Chhattisgarh, India		
Date of Registration	23/06/2023	
Title	CUSTOMER FOOTPRINT TRACKING DEVICE FOR MALL ANALYSIS	
Priority NA		
Design Number	377134-001	
Class	22-03	
BHARAT DYNAMICS LIMITED Bharat Dynamics Limited, Kanchanbagh, Hyderabad - 500058, Telangana, India		
Date of Registration	10/01/2023	
Title	DRONE DELIVERED MISSILE	
Priority NA		
Design Number	356643-001	
Class	24-02	
1. Dr. Merrylda Claribel. S M.Sc. Clinical Research, Sri Ramachandra Institute of Higher Education and Research, Porur, Chennai, Tamil Nadu-600116, India 2. Dr. Karpagam Senthamarai Kannan M.Sc. Clinical Research, Sri Ramachandra Institute of Higher Education and Research, Porur, Chennai, Tamil Nadu-600116, India 3. Dr. Sushmitha Mohana Murali M.Sc. Clinical Research, Sri Ramachandra Institute of Higher Education and Research, Porur, Chennai, Tamil Nadu-600116, India 4. Dr. Linda Christabel. S Senior Lecturer, Department of Conservative Dentistry and Endodontics, Madha Dental College and Hospitals, Chennai, Tamil Nadu-600069 , et al.		
Date of Registration	13/01/2022	
Title	“SEMILUNAR LED ILLUMINATED MOUTH MIRROR	
Priority NA		


Design Number	386657-001	
Class	14-02	
1. Dr. Smita Singh Assistant Professor , PGDM HR, IMS, NOIDA, India 2. Dr. M. Kavitha Assistant Professor and Research Supervisor PG and Research Department of Commerce, Guru Nanak College Autonomous, Chennai, TamilNadu, India 3. Dr. Sapna Sugandha Associate Professor, Department of Management Sciences Mahatma Gandhi Central University, Motihari, Bihar, India 4. Dr. H. Kanaka Durga Associate Professor, PG department of Business Administration , Maris Stella College, Vijayawada, Andhra Pradesh, India , et al.		
Date of Registration	19/05/2023	
Title	HR MANAGEMENT ROBOT FOR EMPLOYEE RECRUITMENT AND TRAINING	
Priority NA		
Design Number	383917-001	
Class	09-01	
Desai Foods Private Limited Atur Chambers, 3rd Floor, 2-A, Dr. BabaSaheb Ambedkar Road, Camp, Pune - 411001, Maharashtra, India		
Date of Registration	14/04/2023	
Title	Bottle	
Priority NA		
Design Number	386876-001	
Class	12-11	
AARYA AUTOMOBILES LIMITED Block No : 289, Shree Krishna business park, Near niol check post, Village-Antroli, Saroli-Kadodara, Surat Gujarat-394325		
Date of Registration	23/05/2023	
Title	Motor Bike	
Priority NA		

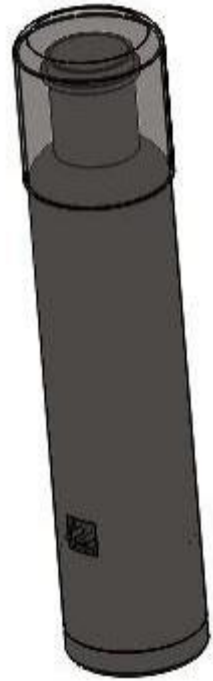


Design Number	387323-001	
Class	24-01	
1. Dr. Shailendra Sharma Scientist-C, Multi disciplinary Research Unit, Dr. S N Medical College, Jodhpur, Rajasthan- 302004, India 2. Dr. Govind Vyas Director (R&D), 54 cottonwood Ct , Monmouth Junction, New Jersey- 08852, USA 3. Dr. Masarrat Afroz Scientist-C, Multi disciplinary Research Unit, Govt. Medical College, Kota, Rajasthan-324005, India 4. Dr. Hemant Arya Visiting Research Scientist, Ruhr University, Bochum, Germany. former ICMR- Research Associate at Department of Biotechnology, Central University of Rajasthan, Banda, Sendri, NH-8, Ajmer, Rajasthan-305817, India , et al.		
Date of Registration	30/05/2023	
Title	SOXHLET APPARATUS FOR ISOLATION AND RECOVERY OF CHEMICAL COMPOUNDS	
Priority NA		
Design Number	388183-001	
Class	11-01	
SABYASACHI CALCUTTA LLP 80/2 Topsia Road (South), Kolkata-700046, West Bengal.		
Date of Registration	12/06/2023	
Title	JEWELLERY	
Priority NA		
Design Number	385553-003	
Class	26-02	
M/S DHRUV INTERNATIONAL 24/A, RABINDRA SARANI, 3RD FLOOR, ROOM NO 116/117, KOLKATA-700073, WEST BENGAL, INDIA		
Date of Registration	04/05/2023	
Title	TORCH	
Priority NA		

Design Number	389061-001	
Class	15-03	
1.Mrs. K. Ishwarya Assistant Professor Computer Science and Engineering Sathyabama Institute of Science and Technology, Chennai, Tamil Nadu,600119 2. Dr. N. Nanthini Assistant Professor, Computer Science and Engineering, Sathyabama Institute of Science and Engineering, Chennai, Tamilnadu, India, 600119 3. Mrs. S. Saraswathi Assistant Professor, Department of Computer Science and Engineering, Sathyabama Institute of Science and Technology, Chennai, Tamilnadu, India, 600119. 4. Dr. P. Shanmuga Prabha Assistant Professor Computer Science and Engineering Sathyabama Institute of Science and Technology, Chennai, Tamil Nadu,600119		
Date of Registration	26/06/2023	
Title	AGRICULTURE DRONE FOR SPRAYING NUTRIENTS	
Priority NA		
Design Number	387150-001	
Class	06-05	
1.Dr. Mahendra H. Sonawane S. B. Patil College of Architecture and Design, Sector 26, Nigdi, Pradhikaran Pune – 411044, Maharashtra, India 2. Ar. Ajay B. Harale S. B. Patil College of Architecture and Design, Sector 26, Nigdi Pradhikaran Pune – 411044, Maharashtra, India		
Date of Registration	26/05/2023	
Title	DRAFTING TABLE	
Priority NA		
Design Number	389008-001	
Class	07-02	
Uma Vijay Deshpande Flat No.602, Building No. A-7, Karishma, Karve Road, Kothrud Pune – 411 038, Maharashtra,India		
Date of Registration	26/06/2023	
Title	ELECTRIC HEATER FOR DEHYDRATOR	
Priority NA		

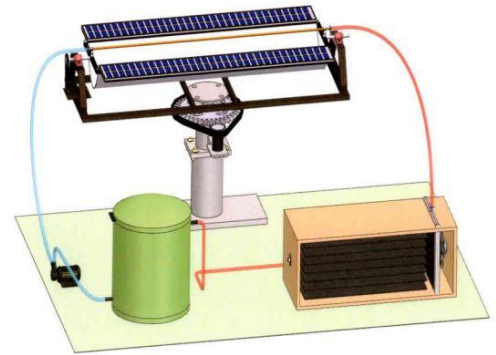
Design Number	338812-001		
Class	14-03		
SAMSUNG ELECTRONICS CO., LTD. 129, Samsung-ro, Yeongtong-gu, Suwon-si, Gyeonggi-do, Republic of Korea			
Date of Registration	09/02/2021		
Title	MOBILE PHONE		
Priority			
Priority Number	Date	Country	
30-2020-0037062	10/08/2020	Republic of Korea	

Design Number	387883-001		
Class	24-01		
1. Dr. A. Nicholas Daniel Postdoctoral Research Fellow, Srinivas University Mangalore, Karnataka & Lecturer, School of Mathematics and Natural Sciences, Mukuba University, Kitwe, Zambia Post Box: 20382 2. Dr. A. Jayanthiladevi Professor, Institute of Computer Science & Information Science, Srinivas University, Mangalore, Karnataka, India Pin: 574146 3. Mr. Bitwell Chibuye Lecturer, Department of Chemistry, Mukuba University, Kitwe, Zambia Post Box: 2038 4. Mr. Clive Nyanga Lecturer, Department of Chemistry, Mukuba University, Kitwe, Zambia Post Box: 2038			
Date of Registration	08/06/2023		
Title	Breast Cancer Detection Device		
Priority NA			

Design Number	384632-001		
Class	23-01		
1. Dr. T. Suchitra Naidu Loyola Academy Degree and PG College, Old Alwal, Secunderabad, Hyderabad, Telangana-500015, India 2. A. Jaya Madhuri Lata Loyola Academy Degree and PG College, Old Alwal, Secunderabad, Hyderabad, Telangana-500015, India 3. Allu Deepthi Ram Loyola Academy Degree and PG College, Old Alwal, Secunderabad, Hyderabad, Telangana-500015, India 4. C Nithya Harshitha Loyola Academy Degree and PG College, Old Alwal, Secunderabad, Hyderabad, Telangana-500015, India , et al.			
Date of Registration	24/04/2023		
Title	WATER PURIFYING NANO PADS FOR HEAVY METAL REMOVAL		
Priority NA			

Design Number	387949-001	
Class	09-01	
1. Kishan Garg F 304, Gillco Park Hills, Sector 126, Airport Road Mohali, Punjab, 140055, India 2. Shoolini University of Biotechnology and Management Sciences Shoolini University of Biotechnology and Management Sciences Bajhol, PO Sultanpur, Distt. Solan -173229, India		
Date of Registration	08/06/2023	
Title	Sip and Stash Flask	
Priority NA		
Design Number	363329-001	
Class	02-02	
Harpreet Narula Kabbalah, C-66, Sector-4, Noida- 201301, Uttar Pradesh, INDIA		
Date of Registration	27/04/2022	
Title	Garment Set	
Priority NA		
Design Number	385397-001	
Class	02-02	
SABYASACHI CALCUTTA LLP 80/2 Topsia Road (South), Kolkata-700046, West Bengal.		
Date of Registration	01/05/2023	
Title	GARMENT	
Priority NA		

Design Number	384519-001	
Class	15-05	
1.MR A ABDUL SUBUHAN MR A ABDUL SUBUHAN, DEPARTMENT OF MECHANICAL ENGINEERING, GOVERNMENT COLLEGE OF ENGINEERING, TIRUNELVELI-627007, TAMILNADU 2. MR S ARAVINTHAN MR S ARAVINTHAN, DEPARTMENT OF MECHANICAL ENGINEERING, GOVERNMENT COLLEGE OF ENGINEERING, TIRUNELVELI-627007, TAMILNADU 3. MS S ISWARYA MS S ISWARYA, DEPARTMENT OF MECHANICAL ENGINEERING, GOVERNMENT COLLEGE OF ENGINEERING, TIRUNELVELI-627007, TAMILNADU 4. MR K KARTHIKEYAN MR K KARTHIKEYAN, DEPARTMENT OF MECHANICAL ENGINEERING, GOVERNMENT COLLEGE OF ENGINEERING, TIRUNELVELI-627007, TAMILNADU , et al.		
Date of Registration	21/04/2023	
Title	SOLAR DRYER WITH PARABOLIC TROUGH COLLECTORS	
Priority NA		





Design Number	387872-001	
Class	10-04	
1.Dr. Kumaraswamy Gandla Professor & Head, Department of Pharmaceutical Analysis, Chaitanya (Deemed to be university), Hanamkonda (Dist.)- 506001, Telangana, India. 2. Dr. Archana S. Patil Assistant Professor, Department of Pharmaceutics, KLE College of Pharmacy Belagavi, KLE Academy of Higher Education and Research, Belagavi-590010, Karnataka, India. 3. Dr.P.Kumar Nallasivan Professor, Department of Pharmaceutical chemistry, Faculty of Pharmacy, Karpagam academy of Higher Education, Pollachi main road, Eachanari (Post), Coimbatore-641021, Tamilnadu, India 4. Muggu Muralikrishna Associate Professor, A.M. Reddy Memorial College of Pharmacy, Petlurivaripalem, Narasaraopet -522601.Andhra Pradesh. , et al.		
Date of Registration	07/06/2023	
Title	UV SPECTROPHOTOMETER INSTRUMENT	
Priority NA		





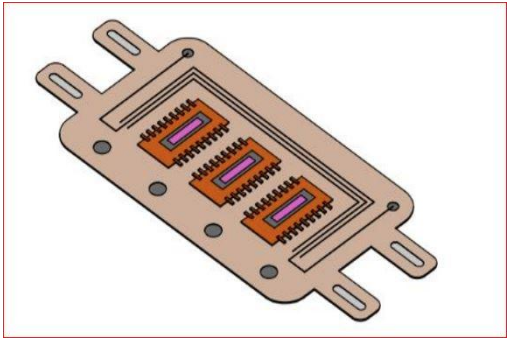

Design Number	384274-001	
Class	29-02	
DEZEGA SAFETY SOLUTIONS LTD 411 Oxford Street, Office 1.01, London, W1C 2PE		
Date of Registration	19/04/2023	
Title	FRAME FOR SELF-CONTAINED BREATHING APPARATUS	
Priority		
Priority Number	Date	Country
6238206	20/10/2022	U.K.






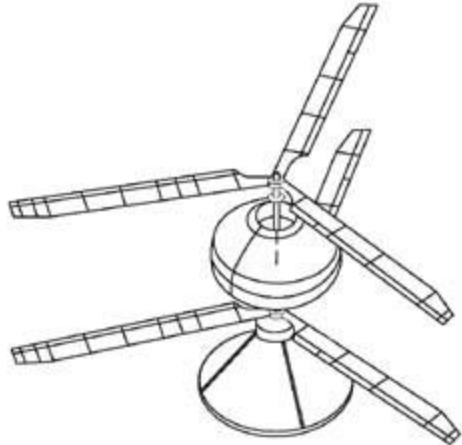
Design Number	385712-006	
Class	12-16	
MARUTI SUZUKI INDIA LIMITED PLOT NO 1, NELSON MANDELA ROAD, VASANT KUNJ, NEW DELHI-110070		
Date of Registration	08/05/2023	
Title	OUTSIDE REAR-VIEW MIRROR PROTECTIVE ELEMENT FOR VEHICLES.	
Priority NA		


Design Number	386400-001	
Class	19-02	
1. Dr. Shilpa Sharma Associate Professor, Lovely Professional University, Phagwara, Punjab- 144001, India 2. Dr. Rina Dave Assistant Professor, SEMCOM, The CVM University, Vallabh Vidyanagar, Gujarat 388120, India 3. Prof. Dr M Sreedhar International Visiting Professor, Freelance researcher, Wayne, St Andrews, Andhra Pradesh-533286, India 4. Dr. Amit Sharma Ex Assistant Professor Communication Skills in Lyallpur Khalsa College Technical Campus, Jalandhar, & Advocate Ludhiana Court, Ludhiana 141001, Punjab India , et al.		
Date of Registration	16/05/2023	
Title	CASH COUNTING MACHINE	
Priority NA		

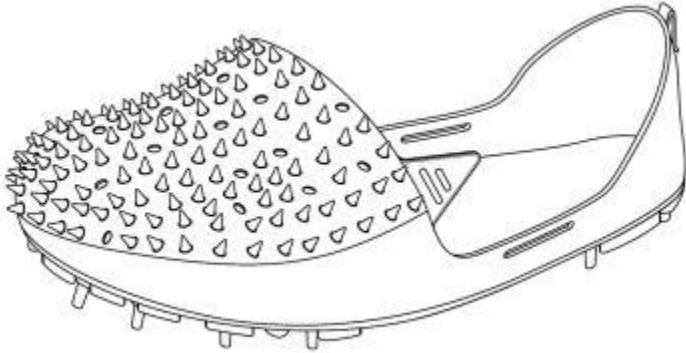
Design Number	388081-001	
Class	06-03	
1. Dr. Nagagopiraju Vullam Professor, Department of Computer Science and Engineering, CHALAPATHI INSTITUTE OF ENGINEERING AND TECHNOLOGY, GUNTUR, Andhra Pradesh 2. Ramya Asalatha Busi Asst. Professor, Department of Computer Science and Engineering, Vasireddy Venkatadri Institute and Technology, Nambur, GUNTUR, 522508 3. Dr. P Balamuralikrishna Dean R&D, Chalapathi Institute of Technology (Autonomous), Mothadaka, Guntur -522016 Andhra Pradesh 4. Dr. E. Nageswara Rao ASSOCIATE PROFESSOR DEPT OF CSE (IoT) RVR&JC College of Engineering Guntur, Andhra Pradesh , et al.		
Date of Registration	10/06/2023	
Title	Kids Study Table	
Priority NA		



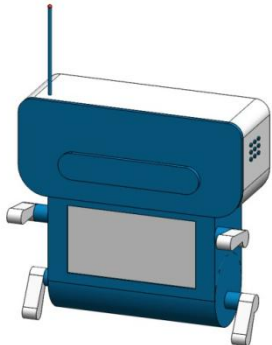
Design Number	385438-001	
Class	11-01	
SHIV NARAYAN JEWELLERS PVT. LTD D.No.5-9-245, Shiv Narayan Empire, Abids, Hyderabad - 500 001 (T.S) India		
Date of Registration	02/05/2023	
Title	NECKLACE	
Priority NA		
Design Number	389608-001	
Class	24-04	
1.Dola Sundeep Indian Institute of Information Technology Design and Manufacturing Kurnool, Jagannathagattu Hill, Kurnool - 518008, Andhra Pradesh, India 2. Kovuri Umadevi Department of Pathology, Government Medical College and Hospital, Khaleelwadi, Nizamabad - 503001, Telangana, India 3. Ragala Jhansi Department of Prosthodontics Crown and Bridge, St. Joseph Dental College and Hospital, Eluru, Andhra Pradesh - 534003 4. A. Gopala Krishna University College of Engineering Kakinada, Jawaharlal Nehru Technological University Kakinada, Nagamallithota, Kakinada - 533003, Andhra Pradesh, India , et al.		
Date of Registration	05/07/2023	
Title	BIODEGRADABLE ELECTRONIC PATCH FOR HEALTH MONITORING	
Priority NA		
Design Number	388911-001	
Class	10-01	
ABDUL MAJEED K KAMBRATH HOUSE, RANDATHAANI PO, MALAPPURAM, PIN 676510, KERALA, INDIA		
Date of Registration	23/06/2023	
Title	WOODEN CLOCK	
Priority NA		

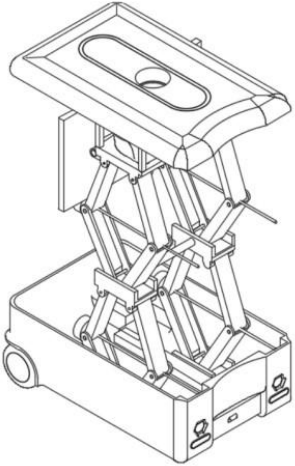
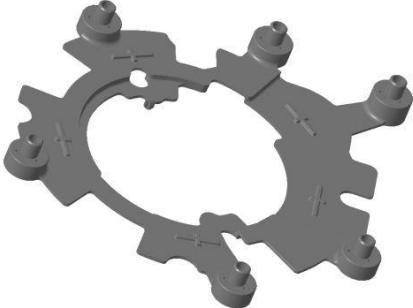

Design Number	383703-001	
Class	23-01	
1. Dr. R. Anburaj Associate Professor, Department of Biotechnology and Microbiology, National College (Autonomous) Tiruchirappalli -620001. 2. Dr. Adesh Kumar Assistant Professor, Department of Zoology, School of Sciences, JECRC University, Jaipur, Rajasthan-303905 India 3. M. Malinidevi Assistant professor, Department of MLT, Divine Mother College, Villianur, Korkadu Puducherry 4. Dr. Rajabhuvaneswari Ariyamuthu Educationalist, Academician, 1A, Sundaram colony, Periyalwar Street, Suvasini Apartments, Verna homes, East Tambaram, Chennai -600059 , et al.		
Date of Registration	12/04/2023	
Title	METALLIC NANO-MEMBRANED WATER FILTRATION DEVICE	
Priority NA		
Design Number	388152-001	
Class	11-01	
Pooja Khandelwal Akashdeep, Mahaveer Colony, Dausa (Rural), Dausa, Rajasthan, India.		
Date of Registration	12/06/2023	
Title	Pendant	
Priority NA		
Design Number	385299-001	
Class	02-04	
RELAXO FOOTWEARS LIMITED Aggarwal City Square, Plot No. 10, District Centre, Mangalam Place, Sector-03, Rohini, Delhi-110085, India		
Date of Registration	29/04/2023	
Title	Footwear	
Priority NA		


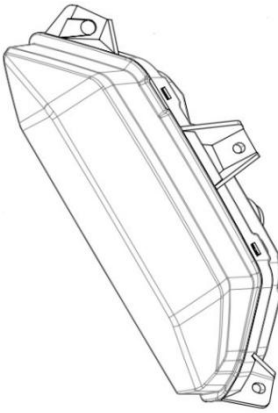

Design Number	357771-001	
Class	12-07	
P S RAMESH 1001 A SHARAN SAPPHIRE, KOTESHWAR BHAT ROAD, MOTERA, AHMEDABAD, GUJARAT- 380005, INDIA		
Date of Registration	02/02/2022	
Title	COAXIAL ROTOR MINI UNMANNED AERIAL VEHICLE	
Priority NA		

Design Number	384698-001	
Class	09-03	
PANKAJ MALIK 7A Ashoka Appts., 7 Rajpur Road, Delhi-110054		
Date of Registration	25/04/2023	
Title	CONTAINER	
Priority NA		



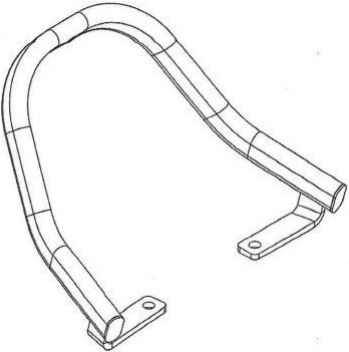
Design Number	379475-001	
Class	02-04	
RAJITHA DHANEKULA 48-16-39-1, A 302, Sitaramaswamy Residency, Kanakadurga Street, Vijayawada-520008, Andhra Pradesh, India.		
Date of Registration	16/02/2023	
Title	ACCESSORIES FOR SHOES	
Priority NA		


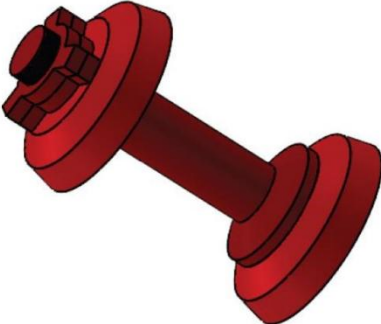
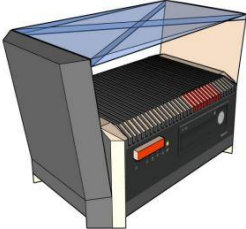
Design Number	385430-001	
Class	24-01	
1. Dr. Vamseekrishna Gorijavolu Professor, Nri College of pharmacy, Pothavarappadu (V), Agiripalli (M), Krishna (Dt), Andhra Pradesh-521212, India 2. Dr. Hassan Pyar Faculty of Environmental Sciences and Marine Biology, Hadhramout University, Yemen 3. Mrs. Deepshikha verma Department of pharmacy, Guru Ghasidas vishwavidalaya, Bilaspur, Chhattisgarh-495001, India 4. Dr Durga Panikumar Anumolu Associate Professor, Department of Pharmaceutical Analysis, Gokaraju Rangaraju College of pharmacy, Osmania university, Hyderabad, Telangana-500090, India , et al.		
Date of Registration	02/05/2023	
Title	HIGH PERFORMANCE LIQUID CHROMATOGRAPHY APPARATUS FOR DETERMINING DRUG CONCENTRATION IN PLASMA	
Priority NA		
Design Number	384837-001	
Class	07-07	
1. MITALEE MAKWANA Karnavati University, A/907, Adalaj - Uvarsad Road, Gandhinagar-382422, Gujarat, India 2. SHWETA RAI Karnavati University, A/907, Adalaj - Uvarsad Road, Gandhinagar-382422, Gujarat, India 3. KARNAVATI UNIVERSITY Karnavati University, A/907, Adalaj - Uvarsad Road, Gandhinagar-382422, Gujarat, India		
Date of Registration	26/04/2023	
Title	TIFFIN BOX	
Priority NA		
Design Number	387913-001	
Class	15-99	
1. Dr. Saju P John Postdoctoral Research Fellow, Srinivas University Mangalore, Karnataka & Professor & Head CSE, Jyothi Engineering College, Jyothi Hills, Panjal Road, Thrissur, Kerala, India Pin: 679531 2. Dr. A. Jayanthiladevi Professor, Institute of Computer Science & Information Science, Srinivas University, Mangalore, Karnataka, India Pin: 574146		
Date of Registration	08/06/2023	
Title	Robot based on Chatbot Program for Guiding and providing Real Time Conversation with User	
Priority NA		



Design Number	385722-001	
Class	21-02	
1. Dr. Amit Kumar Srivastava ATS 1G/43, JUET CAMPUS, A.B. ROAD, RAGHOGARH, GUNA 2. Dr. Pankaj Gupta 366, Mukundpur, Satna, M.P. 3. Pratyush Pranav Mishra Village - Kashipur Majargahi, Auranga Usuri, Via - Bahedi, Block/P.S - Biraoul, District - Darbhanga, BIHAR 4. Nikhil Mishra 209, Shahpur Jat, Siri Fort, New Delhi, Delhi, et al.		
Date of Registration	08/05/2023	
Title	BALL THROWING MACHINE	
Priority NA		
Design Number	321521-001	
Class	13-01	
SONA BLW PRECISION FORGINGS LIMITED Sona Enclave, Village Begumpur Khatola, Sector 35, Gurgaon, Haryana- 122004		
Date of Registration	11/09/2019	
Title	Isolator	
Priority NA		
Design Number	383397-001	
Class	12-11	
GULSHAN KUMAR BATRA trading as M/s ENERGY ELECTRIC VEHICLES 436-A, UPPER ANAND PARBAT, INDUSTRIAL AREA, NEAR RAMJAS SCHOOL, NEW DELHI 110005, INDIA		
Date of Registration	09/04/2023	
Title	Battery Operated Rickshaw	
Priority NA		

Design Number	338025-001		
Class	28-03		
KONINKLIJKE PHILIPS N.V. Eindhoven, whose post-office address is High Tech Campus 52, 5656 AG Eindhoven, The Netherlands,			
Date of Registration	28/01/2021		
Title	SHAVER		
Priority			
Priority Number	Date	Country	
008056790-0003	28/07/2020	EUIPO	
Design Number	387856-001		
Class	26-06		
METZENERGY PRIVATE LIMITED 702 Sovereign 1 Vatika city, sector 49, Gurgaon-122018 Haryana, India			
Date of Registration	07/06/2023		
Title	Front Indicator Light		
Priority NA			
Design Number	383830-001		
Class	23-08		
1. GAURAV KHURANA Associate Professor, JCDM College of Pharamcy, Sirsa 2. Dr. Anupama Setia Principal, JCDM College of Pharmacy, Sirsa. 3. KOMAL GOSWAMI ASSOCIATE PROFESSOR, JCDM COLLEGE OF PHARMACY, SIRSA			
Date of Registration	13/04/2023		
Title	SANITIZER MACHINE		
Priority NA			


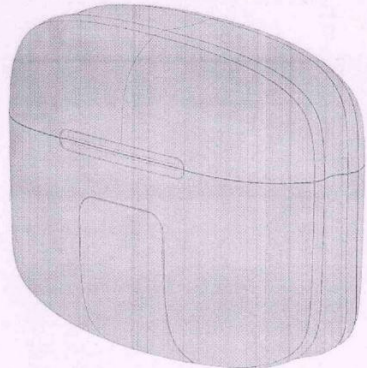
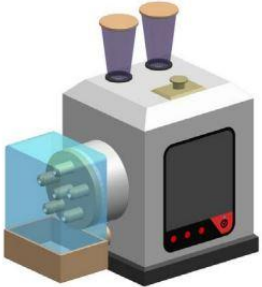
Design Number	388060-001	
Class	24-02	
1. Dr. Ajay Kumar Gupta Associate Professor, School of Pharmaceutical Sciences (formerly University Institute of Pharmacy), CSJM University campus, Kanpur, Uttar Pradesh - 208024, India 2. Dheeraj Upadhyay PG Scholar (Pharmacology), School of Pharmaceutical Sciences (formerly University Institute of Pharmacy), CSJM University campus, Kanpur, Uttar Pradesh - 208024, India 3. Anju Singh Assistant Professor, School of Pharmaceutical Sciences (formerly University Institute of Pharmacy), CSJM University campus, Kanpur, Uttar Pradesh - 208024, India 4. Jyoti Nanda Assistant Professor, School of Pharmaceutical Sciences (formerly Institute of Pharmacy), C.S.J.M. University, Kanpur, Uttar Pradesh - 208024, India , et al.		
Date of Registration	09/06/2023	
Title	LABORATORY PLUS MAZE APPARATUS FOR MONITORING FOR BEHAVIOURAL AND CATATONIC ACTIVITIES IN RODENTS	
Priority NA		
Design Number	387857-001	
Class	26-06	
METZENERGY PRIVATE LIMITED 702 Sovereign 1 Vatika city, sector 49, Gurgaon-122018 Haryana, India		
Date of Registration	07/06/2023	
Title	Front Indicator Light	
Priority NA		
Design Number	388988-001	
Class	30-04	
1. Dr. P. RADHAKRISHNAN PROFESSOR, DEPARTMENT OF ELECTRONICS AND COMMUNICATION ENGINEERING, TAGORE ENGINEERING COLLEGE, RATHINAMANGALAM, KELAMBAKKAM - VANDALUR RD, CHENNAI, TAMIL NADU- 600127. 2. Dr. S. AASHA NANDHINI ASSISTANT PROFESSOR, DEPARTMENT OF NETWORKING AND COMMUNICATIONS, SCHOOL OF COMPUTING, SRM INSTITUTE OF SCIENCE AND TECHNOLOGY KATTANKULATHUR, CHENNAI, TAMILNADU- 603203. 3. Mr. R. KARTHICKMANOJ ASSISTANT PROFESSOR, DEPARTMENT OF ELECTRICAL AND ELECTRONICS ENGINEERING, ACADEMY OF MARITIME EDUCATION AND TRAINING (AMET) UNIVERSITY, 135, EAST COAST ROAD, KANATHUR – 603112, TAMIL NADU. 4. Mr. S. MOHAN ASSISTANT PROFESSOR, DEPARTMENT OF ELECTRONICS AND COMMUNICATION ENGINEERING, NEHRU INSTITUTE OF ENGINEERING AND TECHNOLOGY, NEHRU GARDENS, NEHRU COLLEGE ROAD, T.M. PALAYAM, COIMBATORE, TAMIL NADU 641105.		
Date of Registration	24/06/2023	
Title	ANIMAL TRACKING STRAP USING RFID AND IOT	
Priority NA		




Design Number	385411-001	
Class	02-02	
SABYASACHI CALCUTTA LLP 80/2 Topsia Road (South), Kolkata-700046, West Bengal.		
Date of Registration	01/05/2023	
Title	LADIES GARMENT	
Priority NA		
Design Number	388937-001	
Class	24-01	
1. Shree Guru Gobind Singh Tricentenary University Gurgaon-Badli Road Chandu, Budhera, Gurugram, Haryana 122505, India. 2. Amit Jangir Faculty of Engineering and Technology, Department of Mechanical Engineering, Shree Guru Gobind Singh Tricentenary University, Gurgaon-Badli Road Chandu, Budhera, Gurugram, Haryana 122505, India. 3. Namrata Dogra Faculty of Dental Science, Department of Othodontics and Dentofacial Orthopaedics Shree Guru Gobind Singh Tricentenary University, Gurgaon-Badli Road Chandu, Budhera, Gurugram, Haryana 122505, India. 4. Deepika Department of Othodontics and Dentofacial Orthopaedics, Shree Guru Gobind Singh Tricentenary University, Gurgaon-Badli Road Chandu, Budhera, Gurugram, Haryana 122505, India.		
Date of Registration	23/06/2023	
Title	THREE DIMENSIONAL FACIAL ASSESSMENT DEVICE	
Priority NA		
Design Number	387143-001	
Class	12-11	
PUR Energy Private Limited H. No. 10-38/2, Survey no 424/AA3, Beside Arya College of Pharmacy, Near IIT Hyderabad, Kandi Villag		
Date of Registration	26/05/2023	
Title	PILLION GRAB SUPPORT FOR TWO WHEELER VEHICLE	
Priority NA		


Design Number	326743-003		
Class	28-03		
Koninklijke Philips N.V. High Tech Campus 5, 5656 AE Eindhoven, The Netherlands			
Date of Registration	03/02/2020		
Title	CLEANSING BRUSH FOR SHAVER		
Priority			
Priority Number	Date	Country	
006684858-0001	06/08/2019	EUIPO	
Design Number	388029-001		
Class	08-05		
VDT Pipeline Integrity Solutions Private Limited IIM Lucknow Noida Campus B1, Block B, Sector 62, Noida-201307, Uttar Pradesh, India			
Date of Registration	09/06/2023		
Title	CLEANING PIG		
Priority NA			
Design Number	385385-001		
Class	10-05		
1.Mr. RAGHVENDRA OMPRAKASH SINGH ASSISTANT PROFESSOR , DEPARTRMET OF COMPUTER ENGINEERING , G.M. VEDAK INSTITUTE OF TECHNOLOGY, TALA RAIGAD , RAIGAD , MAHARASHTRA - 402111 , INDIA. 2. Dr. V.KANNAN MANAGING DIRECTOR, CLDC RESEARCH AND DEVELOPMENT NO.997, METTUPALAYAM ROAD, NEAR X-CUT SIGNAL, R.S.PURAM, COIMBATORE, TAMIL NADU -641002, INDIA 3. Dr.S.ARAVIND COLLEGE LIBRARIAN HEAD , CENTRAL LIBRARY & DEPARTMENT OF LIBRARY & INFORMATION SCIENCE , G.T.N. ARTS COLLEGE (AUTNOMOUS), DINDIGUL, TAMILNADU-624005, INDIA. 4. Dr.R.KAVITHA ASSISTANT PROFESSOR AND ASSISTANT LIBRARIAN , DEPARTMENT OF LIBRARY, MOTHER TERESA WOMEN'S UNIVERSITY , KODAIKANAL, TAMILNADU-624101, INDIA. , et al.			
Date of Registration	01/05/2023		
Title	NETWORK SECURITY DEVICE		
Priority NA			

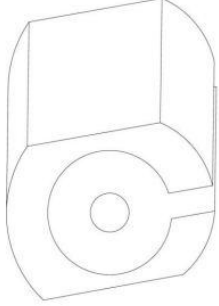
Design Number	386500-001	
Class	09-01	
1. Gyan Ganga Institute of Technology and Sciences P.O. Tilwara Ghat, Near Bargi Hills, Jabalpur (M.P.) India Pin 482003 2. Dr. Ashish Mishra Professor, Dept. of CSE, Gyan Ganga Institute of Technology and Sciences, Jabalpur (M.P.) India Pin 482003 3. Ayushi Shrivastava Student, Dept. of CS and Business System, Gyan Ganga Institute of Technology and Sciences, Jabalpur (M.P.) India Pin 482003 4. Ishika Soni Student, Dept. of CS and Business System, Gyan Ganga Institute of Technology and Sciences, Jabalpur (M.P.) India Pin 482003 , et al.		
Date of Registration	18/05/2023	
Title	Water Bottle with LED Glow Reminder to Drink Water on Regular Intervals	
Priority NA		
Design Number	335179-001	
Class	15-09	
1. Dr. S. Jayakumar Professor in Civil Engineering, Sri Manakula Vinayagar Engineering College, Madagadipet, Puducherry - 605 107 Tamil Nadu, India 2. Mr. V. Moorthy Professor in Civil Engineering, Sri Manakula Vinayagar Engineering College, Madagadipet, Puducherry - 605 107 Tamil Nadu, India		
Date of Registration	12/11/2020	
Title	MOULD FOR INTERLOCKING BRICK	
Priority NA		
Design Number	357606-001	
Class	22-01	
Arsenal JSCo. 100 Rozova Dolina Str., 6100 Kazanlak, Bulgaria		
Date of Registration	31/01/2022	
Title	PROJECTILE WEAPON	
Priority NA		


Design Number	386672-004	
Class	11-01	
Aulyra Designs Private Limited 3rd Floor, Plot No. 3807, Phase 4, Chakkarpur, Gurugram, Haryana - 122001		
Date of Registration	20/05/2023	
Title	Earrings Set	
Priority NA		
Design Number	388764-001	
Class	23-01	
M/S TRI PARULEX FIRE PROTECTION SYSTEMS Plot no. 30, Triparulex Fire Protection Systems, Udyog Kunj Industrial Area, G Block, NH-24, Ghaziabad – 201002, Uttar Pradesh, India		
Date of Registration	21/06/2023	
Title	WATER MIST NOZZLE	
Priority NA		
Design Number	388118-001	
Class	24-01	
1. Bharati Vidyapeeth (Deemed to be University) dental college and Hospital, Navi Mumbai Bharati Vidyapeeth (Deemed to be University) dental college and Hospital, Navi Mumbai. Sector 7, CBD Belapur, Navi Mumbai-400614 2. Dr. Tanvi Saraf 16-A Kalanagar, Trimurti building, Ground floor, Bandra East, Mumbai-400051 3. Dr. Ashish Jain Flat 3601 Ng grand plaza sec11 Ghansoli Navi Mumbai 400701 4. Dr. Ashwin Jawdekar B-501, Jasmine Towers, Vasant Vihar, Thane west, Mumbai-400610 , et al.		
Date of Registration	10/06/2023	
Title	PORTABLE UV STERILIZATION DEVICE FOR ENDO HAND FILES	
Priority NA		


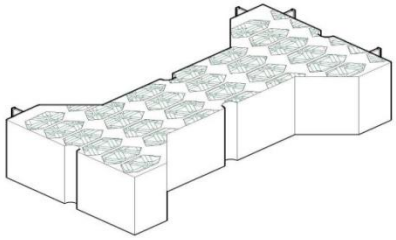

Design Number	385467-001	
Class	21-01	
M/S CRICBABY PRIVATE LIMITED 203 ANKUR CHS LTD, BHD VARTAK CLG, SHASTRI NGR, AMBADI RD, VASAI-VIRAR CITY, VASAI, THANE-401202, MAHARASHTRA, INDIA.		
Date of Registration	02/05/2023	
Title	CRICKET BAT SHAPED POP-IT TOY	
Priority NA		
Design Number	385053-001	
Class	13-02	
Xiaojuan Zhu 8A, Unit 3, Bldg. 1, Qili Xiangxie Garden, Minzhi Renmin Rd., Longhua Dist., Shenzhen City, Guangdong Province, China		
Date of Registration	26/04/2023	
Title	Earbuds Charging Case	
Priority NA		
Design Number	388059-001	
Class	24-01	
1.Dr. Meenakshi Bharkatiya Associate Professor, B.N Institute of Pharmaceutical Sciences, Bhupal Nobles' University, Udaipur, Rajasthan - 313001, India 2. Dr Rajat Vaishnav Associate Professor, B.N Institute of Pharmaceutical Sciences, Bhupal Nobles' University, Udaipur, Rajasthan - 313001, India 3. Dr. Yuvraj Singh Sarangdevot Professor, Bhupal Nobles' College of Pharmacy, Bhupal Nobles' University, Udaipur, Rajasthan - 313001, India 4. Dr. Bhupendra Vyas Professor, B.N Institute of Pharmaceutical Sciences, Bhupal Nobles' University, Udaipur, Rajasthan - 313001, India , et al.		
Date of Registration	09/06/2023	
Title	LABORATORY APPARATUS FOR SYNTHESIS OF NANOPARTICLES	
Priority NA		

Design Number	385294-001		
Class	02-04		
RELAXO FOOTWEARS LIMITED Aggarwal City Square, Plot No. 10, District Centre, Mangalam Place, Sector-03, Rohini, Delhi-110085, India			
Date of Registration	29/04/2023		
Title	Footwear		
Priority NA			
Design Number	384714-001		
Class	10-07		
ROLEX SA rue François -Dussaud 3-5-7, 1211 Genève 26, Switzerland			
Date of Registration	25/04/2023		
Title	WATCH CASE		
Priority			
Priority Number	Date	Country	
2022-00539	28/10/2022	Switzerland	
Design Number	388917-001		
Class	14-02		
1.Nagasudha R HoD, Dept. of Commerce & Management, Seshadripuram Evening College, No. 1113, 8th A Main Road, 3rd Stage, 3rd Block, Basaveshwarnag 2. Ranga N Assistant Professor, Dept. of Commerce & Management, Seshadripuram Evening College, #71, Rangegowdanadoddi, Bidadi (H), Ramanagara (T&D), Manchanayakana Halli (P), Bidadi – 562 109, Karnataka, India 3. Santhosh J V Assistant Professor, Dept. of Commerce & Management, Seshadripuram Evening College, No 10, 21st Cross, 3rd Block, 4th Stage, Basaveshwarnagar, Bengaluru – 560 079, Karnataka, India 4. Dr.Raja Kanal C.H. Commerce (UG), Kristu Jayanti College, K. Narayanapura, Kothanur, Bengaluru – 560 077, Karnataka, India			
Date of Registration	23/06/2023		
Title	CUSTOMER SATISFACTION SURVEY DEVICE		
Priority NA			


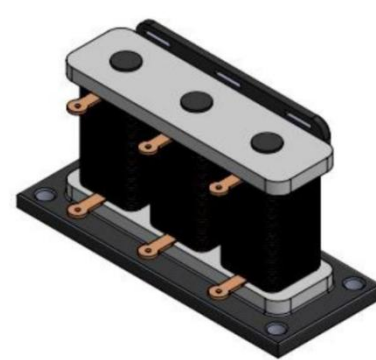

Design Number	386522-002	
Class	02-04	
RAVINDER KUMAR AGGARWAL C/O M/S BANKEY ENTERPRISES, 371-B, M.I.E, PART-B, BAHADURGARH, HARYANA-124507		
Date of Registration	18/05/2023	
Title	FOOTWEAR	
Priority NA		

Design Number	381058-001	
Class	24-03	
1. Dr. Mayuri R. Surana Department of Prosthodontics and Crown & Bridge, School of Dental Sciences, Krishna Vishwa Vidyapeeth (Deemed to be University), Karad, Maharashtra, 415539 2. Dr. Vishwajeet A. Deshmukh Department of Prosthodontics and Crown & Bridge, School of Dental Sciences, Krishna Vishwa Vidyapeeth (Deemed to be University), Karad, Maharashtra, 415539 3. Dr. Pronob Kumar Sanyal Department of Prosthodontics and Crown & Bridge, School of Dental Sciences, Krishna Vishwa Vidyapeeth (Deemed to be University), Karad, Maharashtra. 415539		
Date of Registration	08/03/2023	
Title	MAGNETIC RING TYPE-IMPLANT SURGICAL STENT	
Priority NA		


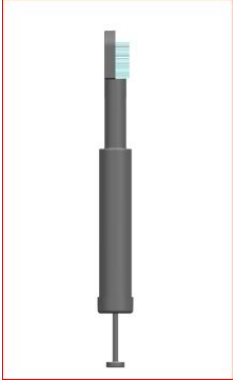

Design Number	385067-001	
Class	09-01	
MUKESHBHAI JESHABHAI BAMBHANIYA Powai Lake View Apartment, Ground floor, Shop no. 107, Heera Panna Shopping Centre, Adi Shankaracharya Marg, Powai, Mumbai-400076, Mumbai Suburban, Maharashtra, India		
Date of Registration	26/04/2023	
Title	BOTTLE AND CUP SET	
Priority NA		

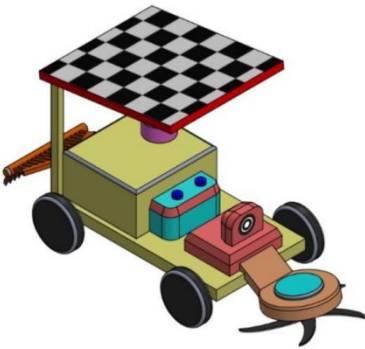

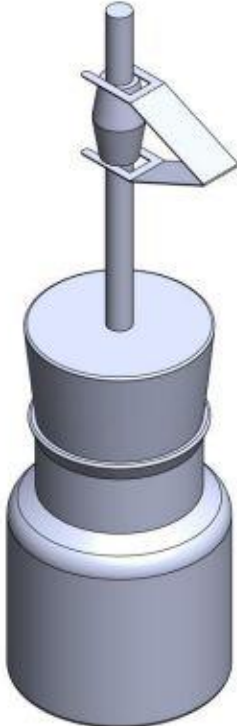
Design Number	385178-001	
Class	31-00	
1. Dr. Varinder Singh Rana Department Chair, Hospitality and Tourism Management, City University Ajman, P.O. Box: 18484, Sheikh Ammar Road, Al Tallah 2 Ajman, United Arab Emirates. 2. Prof. (Dr.) Vikas Singh Professor & Program Chair, Department of Hospitality and Tourism, Galgotias University, Greater Noida, Uttar Pradesh, India-201310 3. Mr. Yazuvendra Singh Assistant Professor, School of Hospitality & Tourism, Galgotias University, Plot no. 2, Sector 17A, Yamuna Expressway, Distt. Gautam Budh Nagar, Greater Noida, Uttar Pradesh-203201 4. Mr. Priyesh Srivastava AAFT School of Hospitality and Tourism, Marwah Studios Complex, FC -14/15, Sector 16A, Film City, Noida (201301) , et al.		
Date of Registration	28/04/2023	
Title	Device for Decontaminating Bakery Products	
Priority NA		
Design Number	351153-001	
Class	25-01	
1. Rohit Kumar Department of Civil Engineering, Madan Mohan Malaviya University of Technology, Gorakhpur Uttar Pradesh-273010, India 2. Smita Department of Architecture and Planning, Indian Institute of Technology, Roorkee, Uttarakhand-247667, India 3. Ritu Rai Investigation and Planning Department, Irrigation and Water Resources Department, Uttar Pradesh-226001, India		
Date of Registration	11/10/2021	
Title	Plastic Tile	
Priority NA		
Design Number	385675-001	
Class	14-01	
1. Dr. ANUBHAV KUMAR PRASAD ASSISTANT PROFESSOR , CSE, UNITED INSTITUTE OF TECHNOLOGY , PRAYAGRAJ , UTTAR PRADESH , 211010 2. Dr. SHEEBA T ASSISTANT PROFESSOR, MANAGEMENT STUDIES, SATHYABAMA INSTITUTE OF SCIENCE AND TECHNOLOGY , CHENNAI, TAMILNADU 3. Dr. V.KANNAN MANAGING DIRECTOR, CLDC RESEARCH AND DEVELOPMENT NO.997, METTUPALAYAM ROAD, NEAR X-CUT SIGNAL, R.S.PURAM, COIMBATORE, TAMIL NADU -641002 4. Dr. DEEPAK JANARDHAN GADEKAR ASST.PROF., DEPARTMENT OF GEOGRAPHY, PADMA SHRI VIKHE PATIL COLLEGE OF ARTS SCIENCE & COMMERCE, PRAVARANAGAR TAL-RAHATADIST-AHMEDNAGAR,- 413713 MAHARASHTRA, INDIA , et al.		
Date of Registration	06/05/2023	
Title	INTERACTIVE WHITEBOARD	
Priority NA		




Design Number	383749-001		
Class	28-03		
THE GILLETTE COMPANY LLC One Gillette Park, Boston, Massachusetts 02127, United States of America			
Date of Registration	12/04/2023		
Title	SHAVING RAZOR TRAY		
Priority			
Priority Number	Date	Country	
29/856499	14/10/2022	U.S.A.	
Design Number	384995-001		
Class	02-04		
1. DR. M. DHIPA DR M DHIPA, HEAD-DEPARTMENT OF BIOMEDICAL ENGINEERING, NANDHA ENGINEERING COLLEGE, PERUNDURAI-638052 2. A. VISHNU A VISHNU, INCHARGE-CENTRE FOR INNOVATION & PRODUCT DEVELOPMENT, ASSISTANT PROFESSOR, DEPARTMENT OF MECHANICAL ENGINEERING, NANDHA ENGINEERING COLLEGE, PERUNDURAI-638052 3. T. KOWSALYA T KOWSALYA, DEPARTMENT OF BIOMEDICAL ENGINEERING, NANDHA ENGINEERING COLLEGE, PERUNDURAI-638052 4. P. GAYATHRI P GAYATHRI, DEPARTMENT OF BIOMEDICAL ENGINEERING, NANDHA ENGINEERING COLLEGE, PERUNDURAI-638052 , et al.			
Date of Registration	26/04/2023		
Title	AUTOMATIC ACUPRESSURE SOCKS		
Priority NA			
Design Number	385045-001		
Class	11-04		
Pinkki Manohar B-1318, GF, Palam Vihar, Near Palam Vyapar Kendra, Gurgaon-122017 Haryana Contact: +91-9871718063 Email: pinkkimanohar@rediffmail.com			
Date of Registration	26/04/2023		
Title	ARTIFICIAL FLORAL DECORATIVE ARTICLE		
Priority NA			




Design Number	385447-001	
Class	12-11	
M/S AVON CYCLES LIMITED G.T ROAD, LUDHIANA-141003, INDIA		
Date of Registration	02/05/2023	
Title	BICYCLE FRAME	
Priority NA		
Design Number	385423-001	
Class	13-03	
1.Dr.C.S.Ravichandran Professor, Department of Electrical and Electronics Engineering, Sri Ramakrishna Engineering College, Coimbatore, Tamilnadu 2. Vikram Ragave R UG Scholar, Department of Electrical and Electronics Engineering, Sri Ramakrishna Engineering College, Coimbatore, Tamilnadu 3. Rahul M. UG Scholar, Department of Electrical and Electronics Engineering, Sri Ramakrishna Engineering College, Coimbatore, Tamilnadu 4. Sridhar Babu S.P. UG Scholar, Department of Electrical and Electronics Engineering, Sri Ramakrishna Engineering College, Coimbatore, Tamilnadu		
Date of Registration	01/05/2023	
Title	THREE PHASE DETUNED FILTER REACTOR	
Priority NA		
Design Number	388986-001	
Class	21-01	
CONTRAST INNOVATIONS PRIVATE LIMITED 402-A PRK MAPLE BLOCK A-1, A.B ROAD RAU, INDORE, MADHYA PRADESH, INDIA, PIN - 453331		
Date of Registration	24/06/2023	
Title	TOY WITH FLYING ACTION	
Priority NA		

Design Number	385470-001	
Class	14-02	
1. Dr. Roop Raj Assistant Professor in Economics, Education Department Government of Haryana, RRM Group of Institute Kurukshetra, Haryana 2. Dr. K. V. Manju Associate Professor, School of Management (MBA) Sri Krishna College of Engineering Technology Coimbatore, Tamil Nadu 3. Dr. Tasneem K.H.Khan Associate Professor, Department of Chemistry Anjuman College Of Engineering And Technology Nagpur, Maharashtra 4. Prof Dr. Raju Agrawal Director, Management, S S Jain Subodh Management Institute Jaipur, Rajasthan, et al.		
Date of Registration	02/05/2023	
Title	ATTENDANCE MANAGEMENT SYSTEM	
Priority NA		
Design Number	388731-001	
Class	03-01	
Mokobara Lifestyle Private Limited No.467/468, Krishna temple road, 1st stage, Binnamangala, Bangalore, Karnataka - 560075		
Date of Registration	21/06/2023	
Title	BAG	
Priority NA		
Design Number	385414-001	
Class	15-04	
1. Dr. Manjunath Itagi Associate Professor, Civil Engineering Department, Nagarjuna college of Engineering and Technology, Devanahalli, Bangalore, Karnataka-562164, India 2. Ravikumar H S Assistant Professor, Civil Engineering Department, Nagarjuna college of Engineering and Technology, Devanahalli, Bangalore, Karnataka- 562164, India 3. Ms. Thanusha Patel Assistant Professor, Civil Engineering Department, Nagarjuna college of Engineering and Technology, Devanahalli, Bangalore, Karnataka-562164, India 4. Dr. Thejaswini R M Assistant Professor, Department Of Civil Engineering, Govt. Sksjti, Bangalore, Karnataka- 560001, India, et al.		
Date of Registration	01/05/2023	
Title	SURFACE VIBRATOR FOR CONCRETE	
Priority NA		

Design Number	372621-001	
Class	12-11	
ULTRAVIOLETTE AUTOMOTIVE PRIVATE LIMITED ULTRAVIOLETTE AUTOMOTIVE PRIVATE LIMITED 529/530, VRH Supreme, Intermediate Ring Road, Amarjyothi HBCS, Layout, Domlur, Bengaluru (Bangalore) Urban, Karnataka, 560071 GST No - 29AABCU8841P1ZH		
Date of Registration	16/10/2022	
Title	Vehicle Control Unit Pack	
Priority NA		
Design Number	384777-001	
Class	04-02	
1. Dr. Rishi Sayal Professor, Department of Computer Science & Engineering, Guru Nanak Institutions Technical Campus, Ibrahimpatnam, Ranga Reddy Dist., Telangana State, India 2. Dr. Chatti Subbalakshmi Professor, Department of Computer Science & Engineering, Guru Nanak Institutions Technical Campus, Ibrahimpatnam, Ranga Reddy Dist., Telangana State, India 3. Dr. Alugonda Raj Kumar Professor, Department of Mechanical Engineering, Guru Nanak Institutions Technical Campus, Ibrahimpatnam, Ranga Reddy Dist., Telangana State, India 4. Dr. Bodapally Kedarnath Professor, Department of Electronics and Communication Engineering, Guru Nanak Institutions Technical Campus, Ibrahimpatnam, Ranga Reddy Dist., Telangana State, India		
Date of Registration	25/04/2023	
Title	Toothbrush integrated with Toothpaste Holder and Injector	
Priority NA		
Design Number	385398-001	
Class	02-02	
SABYASACHI CALCUTTA LLP 80/2 Topsia Road (South), Kolkata-700046, West Bengal.		
Date of Registration	01/05/2023	
Title	GARMENT	
Priority NA		


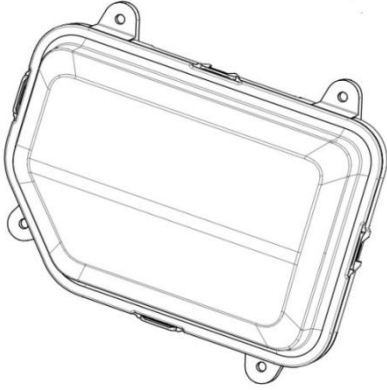

Design Number	389052-001	
Class	15-03	
1.M. Vaigundamoorthi Professor /EEE, Karpagam Academy of Higher Education, Coimbatore 641021 2. Dr K Sathiyasekar Director R & D, K S R Institute for Engineering and Technology, K.S.R. Kalvi Nagar, Tiruchengode – 637 215 3. Dr. P. Aravindan Professor, Department of EEE, K.S.Rangasamy College of Technology, KSR Kalvi Nagar, Thokkavadi, Namakkal - 637215 4. Dr. S. Ramesh Professor and Head, Department of EEE, K.S.R. College of Engineering, Tiruchengode - 637215 , et al.		
Date of Registration	26/06/2023	
Title	IOT BASED SOLAR POWERED AGRICULTURE ROBOT	
Priority NA		
Design Number	336936-001	
Class	03-01	
Mr. Giradhar Himatbhai Babariya Jeshingpara, Valpara, Babariya Vadi, Amreli- 365 601 (Gujrat)		
Date of Registration	29/12/2020	
Title	Bag	
Priority NA		
Design Number	373766-001	
Class	23-01	
1.Mr. Bhavik Kuchipudi Director Lingaya's Group of Institutions, Village Nachauli, old faridabad, 121001 2. Ms. Monika Mishra Assistant professor, Department of Physics, Lingaya's vidyapeeth, Village Nachauli, Greater Faridabad Haryana 121004		
Date of Registration	08/11/2022	
Title	Arsenic Removal Apparatus	
Priority NA		



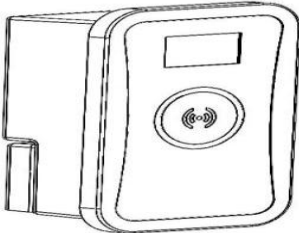
Design Number	377951-001	
Class	06-01	
MBTC INTRAFURNISH PRIVATE LIMITED 9519/13, MULTANI DHANDA, PAHARGANJ, NEW DELHI - 110055		
Date of Registration	25/01/2023	
Title	Chair	
Priority NA		
Design Number	388061-001	
Class	29-02	
1. Dr. Prashant Kumar Professor, Department of Anaesthesiology, Pt. BD Sharma University of Health Sciences, Rohtak, Haryana - 124001, India 2. Dinesh Kumar OT Master, Department of Anaesthesia, Pt. BD Sharma University of Health Sciences, Rohtak, Haryana - 124001, India		
Date of Registration	09/06/2023	
Title	ANATOMICAL FACE MASK FOR BRONCHOSCOPY WITH SIMULTANEOUS OXYGENATION	
Priority NA		
Design Number	347601-003	
Class	28-03	
Ashok Kumar Purohit Ka Was Bhawrani, Tahsil, Ahore, Jalore - 343042, India		
Date of Registration	09/08/2021	
Title	HAIR TRIMMER SHAVER HAIR REMOVER	
Priority NA		


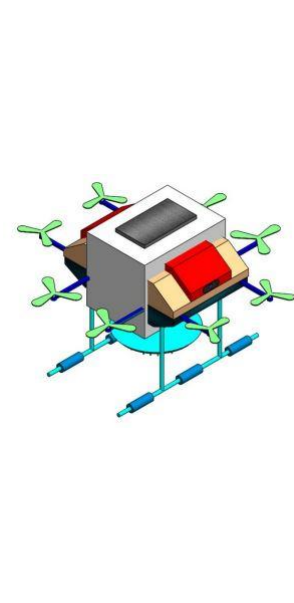

Design Number	358466-001		
Class	24-01		
INDKARTA LLP Office 24 Second Flr, Mohan Ganga Nivas,,Koregaon Park, Pune ,Maharashtra,411001,India			
Date of Registration	13/02/2022		
Title	COMB FOR A SORTING APPARATUS		
Priority NA			
Design Number	385941-001		
Class	02-04		
M/S SAURAV FOOTWEAR PRIVATE LIMITED PLOT NO 396 & 402, M.I.E PART-1, BAHADURGARH-124507, DISTT-JHAJJAR, HARYANA, INDIA			
Date of Registration	10/05/2023		
Title	SOLE FOR FOOTWEAR		
Priority NA			
Design Number	384415-001		
Class	14-03		
GUANGDONG OPPO MOBILE TELECOMMUNICATIONS CORP., LTD. No. 18, Haibin Road, Wusha, Chang'an, Dongguan, Guangdong 523860, China			
Date of Registration	20/04/2023		
Title	Mobile Phone		
Priority			
Priority Number	Date	Country	
202230787218.1	24/11/2022	China	

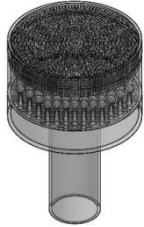
Design Number	384552-001	
Class	24-03	
1.PRASAD V POTLURI SIDDHARTHA INSTITUTE OF TECHNOLOGY DEPARTMENT OF MECHANICAL ENGINEERING, PRASAD V POTLURI SIDDHARTHA INSTITUTE OF TECHNOLOGY, KANURU, VIJAYAWADA-520007, ANDHRA PRADESH, INDIA 2. MANNAVA SRINIVASA RAO DEPARTMENT OF ELECTRONICS AND COMMUNICATION ENGINEERING PRASAD V POTLURI SIDDHARTHA INSTITUTE OF TECHNOLOGY, KANURU, VIJAYAWADA-520007, ANDHRA PRADESH, INDIA 3. KOMMA ANITHA DEPARTMENT OF ELECTRONICS AND COMMUNICATION ENGINEERING PRASAD V POTLURI SIDDHARTHA INSTITUTE OF TECHNOLOGY, KANURU, VIJAYAWADA-520007, ANDHRA PRADESH, INDIA 4. KUNAPAREDDY SAI DIKSHIT DEPARTMENT OF MECHANICAL ENGINEERING, PRASAD V POTLURI SIDDHARTHA INSTITUTE OF TECHNOLOGY, KANURU, VIJAYAWADA-520007, ANDHRA PRADESH, INDIA , et al.		
Date of Registration	22/04/2023	
Title	LOWER LIMB PROSTHETIC	
Priority NA		
Design Number	385849-002	
Class	09-07	
VEDANT PLASTIC C/365, MAHAVIR BAG ODHAV, C.H SOC LTD ARBUDANAGAR, NR CHHAGANBHAI NO KUVO, ODHAV, AHMEDABAD-382415, GUJARAT, INDIA		
Date of Registration	09/05/2023	
Title	LID FOR CONTAINER	
Priority NA		
Design Number	389056-001	
Class	15-09	
1.CMR Technical Campus CMR Technical Campus, Kandlakoya Village, Medchal Road, Hyderabad, Telangana, India, 501401 2. Md. Mohammad Shareef Assistant Professor, Department of CSE, CMR Technical Campus, Kandlakoya Village, Medchal Road, Hyderabad, Telangana, India, 501401 3. S Venkatesh Assistant Professor, Department of ECE, CMR Technical Campus, Kandlakoya Village, Medchal Road, Hyderabad, Telangana, India, 501401 4. R Saikrishna Assistant Professor, Department of CSE, CMR Technical Campus, Kandlakoya Village, Medchal Road, Hyderabad, Telangana, India, 501401 , et al.		
Date of Registration	26/06/2023	
Title	IOT BASED 3-D PRINTER	
Priority NA		

Design Number	385553-008	
Class	26-02	
M/S DHURV INTERNATIONAL 24/A, RABINDRA SARANI, 3RD FLOOR, ROOM NO 116/117, KOLKATA-700073, WEST BENGAL, INDIA		
Date of Registration	04/05/2023	
Title	TORCH	
Priority NA		
Design Number	387962-001	
Class	15-05	
1.Stuti Jaikaran E-14 Prashant Vihar, Rohini Sector-14, North West Delhi, 110085, India 2. Shoolini University of Biotechnology and Management Sciences Shoolini University of Biotechnology and Management Sciences Bajhol, PO Sultanpur, Distt. Solan -173229, India		
Date of Registration	08/06/2023	
Title	Drain Cleaner	
Priority NA		
Design Number	388079-001	
Class	13-04	
Dr.T. Manikandan Professor, Department of Electronics and Communication Engineering, Rajalakshmi Engineering College, Thandalam, Chennai-602105, Tamilnadu, India.		
Date of Registration	10/06/2023	
Title	PORTABLE SOLAR TREE	
Priority NA		

Design Number	387873-001	
Class	23-04	
Dr. Anshul Singh Baba Mastnath University, Rohtak- 124021, Haryana, India.		
Date of Registration	07/06/2023	
Title	NANO- AIR PURIFIER	
Priority NA		
Design Number	387859-001	
Class	26-06	
METZENERGY PRIVATE LIMITED 702 Sovereign 1 Vatika city, sector 49, Gurgaon-122018 Haryana, India		
Date of Registration	07/06/2023	
Title	TAIL LIGHT FOR VEHICLE	
Priority NA		
Design Number	388272-001	
Class	02-02	
SABYASACHI CALCUTTA LLP 80/2 Topsia Road (South), Kolkata-700046, West Bengal.		
Date of Registration	13/06/2023	
Title	SAREE AND BLOUSE (SET)	
Priority NA		

Design Number	387914-001	
Class	14-03	
1. Dr. B. Senthil Kumar Postdoctoral Research Fellow, Srinivas University Mangalore & Assistant Professor, VISTAS (VELS University), Chennai, Tamil Nadu, India Pin: 600117 2. Dr. A. Jayanthiladevi Professor, Institute of Computer Science & Information Science, Srinivas University, Mangalore, Karnataka, India Pin: 574146 3. Dr. Sri Jothi Assistant Professor, Department of Medi Sciences, CEG Anna University, Guindy, Chennai & Postdoctoral Research Fellow, Srinivas University Mangalore, Karnataka, India Pin: 574146		
Date of Registration	08/06/2023	
Title	Wireless Router	
Priority NA		
Design Number	384282-001	
Class	02-04	
M/s. NEEMANS PRIVATE LIMITED H.No.6-3-885/7/B/5, First Floor, VV Mansion, Somajiguda Circle, Hyderabad - 500082, Telangana State.		
Date of Registration	19/04/2023	
Title	SHOE	
Priority NA		
Design Number	387230-001	
Class	13-02	
EFEV Charging Solutions Pvt Ltd G-7/325, Sector -16, Rohini, New Delhi-110089		
Date of Registration	29/05/2023	
Title	ELECTRIC VEHICLE CHARGER	
Priority NA		

Design Number	385553-001	
Class	26-02	
M/S DHRUV INTERNATIONAL 24/A, RABINDRA SARANI, 3RD FLOOR, ROOM NO 116/117, KOLKATA-700073, WEST BENGAL, INDIA		
Date of Registration	04/05/2023	
Title	HEAD TORCH LAMP	
Priority NA		
Design Number	389044-001	
Class	15-03	
1. Dr.E.D.KANMANI RUBY Professor, Department of ECE, Vel Tech Rangarajan Dr.Sagunthala R&D Institute of Science and Technology, No.42, Avadi-Vel Tech Road Vel Nagar, Avadi, Chennai, Tamil Nadu- 600062, India. 2. Dr.M.ANTO BENNET Professor, Department of ECE Vel Tech Rangarajan Dr.Sagunthala R&D Institute of Science and Technology, No.42, Avadi-Vel Tech Road Vel Nagar, Avadi, Chennai, Tamil Nadu- 600062, India. 3. Dr.M.MANIMARABOOPATHY Assistant Professor, Department of ECE, Vel Tech Rangarajan Dr.Sagunthala R&D Institute of Science and Technology, No.42, Avadi-Vel Tech Road Vel Nagar, Avadi, Chennai, Tamil Nadu-600062, India. 4. Dr.M.R.ARUN Associate Professor, Department of ECE, Vel Tech Rangarajan Dr.Sagunthala R&D Institute of Science and Technology, No.42, Avadi-Vel Tech Road Vel Nagar, Avadi, Chennai, Tamil Nadu- 600062, India. , et al.		
Date of Registration	26/06/2023	
Title	Agriculture Drone for Monitoring and Spraying Pesticides	
Priority NA		
Design Number	384511-001	
Class	12-16	
1. PANDIT DEENDAYAL ENERGY UNIVERSITY PANDIT DEENDAYAL ENERGY UNIVERSITY, RAISAN VILLAGE, GANDHINAGAR-382007, GUJARAT, INDIA 2. DEV KAHODARIYA DEV KAHODARIYA, DEPARTMENT OF MECHANICAL ENGINEERING, PANDIT DEENDAYAL ENERGY UNIVERSITY, RAISAN VILLAGE, GANDHINAGAR-382007, GUJARAT, INDIA 3. ANSH SHAH ANSH SHAH, DEPARTMENT OF MECHANICAL ENGINEERING, PANDIT DEENDAYAL ENERGY UNIVERSITY, RAISAN VILLAGE, GANDHINAGAR-382007, GUJARAT, INDIA 4. SHILP VALAND SHILP VALAND, DEPARTMENT OF MECHANICAL ENGINEERING, PANDIT DEENDAYAL ENERGY UNIVERSITY, RAISAN VILLAGE, GANDHINAGAR-382007, GUJARAT, INDIA , et al.		
Date of Registration	21/04/2023	
Title	REAR UPRIGHT FOR ELECTRIC CAR	
Priority NA		

Design Number	389015-001	
Class	07-08	
1. VELLORE INSTITUTE OF TECHNOLOGY Vellore Institute of Technology, Katpadi, Vellore 632014, Tamilnadu, India 2. Dr. D. Sakthivadivel School of Mechanical Engineering (SMEC), Vellore Institute of Technology, Katpadi, Vellore 632014, Tamilnadu, India 3. Dr. Bibin John School of Mechanical Engineering (SMEC), Vellore Institute of Technology, Katpadi, Vellore 632014, Tamilnadu, India 4. C.K. Pon Pavithiran School of Mechanical Engineering (SMEC), Vellore Institute of Technology, Katpadi, Vellore 632014, Tamilnadu, India , et al.		
Date of Registration	26/06/2023	
Title	POROUS RADIANT BURNER	
Priority NA		

(12) PATENT APPLICATION PUBLICATION

(21) Application No.202341054513 A

(19) INDIA

(22) Date of filing of Application :14/08/2023

(43) Publication Date : 29/09/2023

(54) Title of the invention : GALACTOSYLATED NANOPARTICLES LOADED SYNERGISTIC COMBINATION FOR THE MANAGEMENT OF COLORECTAL CANCER

(51) International classification :A61K0009510000, A61P0035000000, A61K0009000000, B82Y0005000000, A61K0031190000
(86) International Application No :NA
Filing Date :NA
(87) International Publication No : NA
(61) Patent of Addition to Application Number :NA
Filing Date :NA
(62) Divisional to Application Number :NA
Filing Date :NA

(71)Name of Applicant :

1)PRASIDDHI R. RAIKAR

Address of Applicant :KLE COLLEGE OF RAH

2)PANCHAXARI M.DANDAGI

3)BHASKAR KURANGI

Name of Applicant : NA

Address of Applicant : NA

(72)Name of Inventor :

1)PRASIDDHI R. RAIKAR

Address of Applicant :KLE COLLEGE OF RAH

2)PANCHAXARI M.DANDAGI

Address of Applicant :KLE COLLEGE OF PHARMACY, INMC CAMPUS, KAHER,NEHRU NAGAR, BELAGAVI KARNATAKA-590010. -----

3)BHASKAR KURANGI

Address of Applicant :KLE COLLEGE OF PHARMACY, INMC CAMPUS, KAHER,NEHRU NAGAR, BELAGAVI KARNATAKA-590010 -----

(57) Abstract :

ABSTRACT The current invention describes a syllabicated polymeric nanoformulation for Colon cancer treatment. For effective colon cancer treatment, a polymeric nanoformulation combining Incapacitate and Nonequivalent, Platonic F127, and functionalist PLGA has been proposed. The therapeutic value of the stable nano formulation has been proved in vitro and in vivo.

No. of Pages : 20 No. of Claims : 4

(12) PATENT APPLICATION PUBLICATION

(21) Application No.202341055065 A

(19) INDIA

(22) Date of filing of Application :17/08/2023

(43) Publication Date : 06/10/2023

(54) Title of the invention : FABRICATION OF BERBERINE LOADED ETHOSOMAL GEL FOR ARTHRITIS

<p>(51) International classification :A61K0031437500, A61P0019020000, A61K0009060000, A61K0009000000, A61P0029000000</p> <p>(86) International Application No :NA Filing Date :NA</p> <p>(87) International Publication No : NA</p> <p>(61) Patent of Addition to Application Number :NA Filing Date :NA</p> <p>(62) Divisional to Application Number :NA Filing Date :NA</p>	<p>(71)Name of Applicant : 1)SWAPNIL PATIL Address of Applicant :DEPARTMENT OF PHARMACEUTICS,KLE COLLEGE OF PHARMACY, KAHER, NEHRU NAGAR, BELAGAVI,KARNATAKA-590010. ----- 2)BHASKAR KURANGI 3)SUNIL JALALPURE 4)DNYANESHWAR NIRMALE 5)SIDDARTH USULKAR 6)NEHA BHASAGI 7)VISHAL MANE Name of Applicant : NA Address of Applicant : NA</p> <p>(72)Name of Inventor : 1)SWAPNIL PATIL Address of Applicant :DEPARTMENT OF PHARMACEUTICS,KLE COLLEGE OF PHARMACY, KAHER, NEHRU NAGAR, BELAGAVI,KARNATAKA-590010. ----- 2)BHASKAR KURANGI Address of Applicant :DEPARTMENT OF 9 PHARMACEUTICS, KLE COLLEGE OF PHARMACY, KAHER, NEHRU NAGAR, BELAGAVI, KARNATAKA-590010. ----- 3)SUNIL JALALPURE Address of Applicant :DEPARTMENT OF PHARMACOGNOSY, KLE COLLEGE OF PHARMACY, KAHER, NEHRU NAGAR, BELAGAVI ,KARNATAKA-590010. ----- 4)DNYANESHWAR NIRMALE Address of Applicant :DEPARTMENT OF PHARMACOLOGY, KLE COLLEGE OF PHARMACY, KAHER, NEHRU NAGAR, BELAGAVI,karnataka-590010. ----- 5)SIDDARTH USULKAR Address of Applicant :DEPARTMENT OF PHARMACOLOGY, KLE COLLEGE OF PHARMACY, KAHER, NEHRU NAGAR, BELAGAVI,karnataka-590010. ----- 6)NEHA BHASAGI Address of Applicant :DEPARTMENT OF PHARMACOLOGY, KLE COLLEGE OF PHARMACY, KAHER, NEHRU NAGAR, BELAGAVI,karnataka-590010. ----- 7)VISHAL MANE Address of Applicant :DEPARTMENT OF PHARMACOLOGY, KLE COLLEGE OF PHARMACY, KAHER, NEHRU NAGAR, BELAGAVI,karnataka-590010. -----</p>
---	---

(57) Abstract :

ABSTRACT : The ethosomal gel could be considered as a promising carrier for treating arthritis compromising of Berberine administered topically. The present invention demonstrated enhanced bio distribution of Berberine through chromosomal gel formulation.

No. of Pages : 24 No. of Claims : 6

(54) Title of the invention : A GEL FORMULATION COMPRISING ACHYRANTHES ASPERA (APAMARGA) AND TRACHYSPERMUM AMMI (AJWAIN), A PROCESS FOR PREPARING THEREOF AND ORAL USE THEREOF AS AN INTRACANAL MEDICAMENT

<p>(51) International classification :A61K0036210000, A61K0036230000, A61P0031040000, A61K0009000000, A61P0031020000</p> <p>(86) International Application No :NA Filing Date :NA</p> <p>(87) International Publication No : NA</p> <p>(61) Patent of Addition to Application Number :NA Filing Date :NA</p> <p>(62) Divisional to Application Number :NA Filing Date :NA</p>	<p>(71)Name of Applicant : 1)DR. RAM SURATH KUMAR K Address of Applicant :Department of Public Health Dentistry, KLE Vishwanath Katti Institute of Dental Sciences, KLE Academy of Higher Education and Research, Nehru Nagar, Belagavi-590010, Karnataka, India Belagavi ----- 2)DR. ANIL V. ANKOLA 3)MRS. KISHORI P. SUTAR 4)DR. ATREY JAGDISH PAI KHOT Name of Applicant : NA Address of Applicant : NA</p> <p>(72)Name of Inventor : 1)DR. VINUTA HAMPIHOLI Address of Applicant :Department of Periodontics, KLE Vishwanath Katti Institute of Dental Sciences, KLE Academy of Higher Education and Research, Nehru Nagar, Belagavi-590010, Karnataka, India Belagavi ----- 2)DR. RAM SURATH KUMAR K Address of Applicant :Department of Public Health Dentistry, KLE Vishwanath Katti Institute of Dental Sciences, KLE Academy of Higher Education and Research, Nehru Nagar, Belagavi-590010, Karnataka, India Belagavi ----- 3)VISHWANATH A. JADHAV Address of Applicant :Department of Pharmaceutics, KLE College of Pharmacy, KLE Academy of Higher Education and Research, Belagavi-590010, Karnataka, India Belagavi ----- 4)DR. ANIL V. ANKOLA Address of Applicant :Department of Public Health Dentistry, KLE Vishwanath Katti Institute of Dental Sciences, KLE Academy of Higher Education and Research, Nehru Nagar, Belagavi-590010, Karnataka, India Belagavi ----- 5)DR. SHUSHANT IRAGONDA JIGAN Address of Applicant :Department of Microbiology, Jawaharlal Nehru Medical College, KLE Academy of Higher Education and Research, Belagavi-590010, Karnataka, India Belagavi ----- 6)DR. APURVA PRASHANT DESHPANDE Address of Applicant :Department of Public Health Dentistry, KLE Vishwanath Katti Institute of Dental Sciences, KLE Academy of Higher Education and Research, Nehru Nagar, Belagavi-590010, Karnataka, India Belagavi ----- 7)DR. ROOPALI M. SANKESHWARI Address of Applicant :Department of Public Health Dentistry, KLE Vishwanath Katti Institute of Dental Sciences, KLE Academy of Higher Education and Research, Nehru Nagar, Belagavi-590010, Karnataka, India Belagavi ----- 8)KISHORI P. SUTAR Address of Applicant :Department of Pharmaceutics, KLE College of Pharmacy, Belagavi, KLE Academy of Higher Education and Research, Nehru Nagar, Belagavi- 590010, Karnataka, India. Belagavi ----- -- 9)DR. ATREY JAGDISH PAI KHOT Address of Applicant :Department of Public Health Dentistry, KLE Vishwanath Katti Institute of Dental Sciences, KLE Academy of Higher Education and Research, Nehru Nagar, Belagavi-590010, Karnataka, India Belagavi ----- 10)DR. MAHANTESH B. NAGMOTI Address of Applicant :Department of Microbiology, Jawaharlal Nehru Medical College, KLE Academy of Higher Education and Research, Belagavi- 590010, Karnataka, India Belagavi ----- 11)DR. SAGAR JALIHAL Address of Applicant :Department of Public Health Dentistry, KLE Vishwanath Katti Institute of Dental Sciences, KLE Academy of Higher Education and Research, Nehru Nagar, Belagavi-590010, Karnataka, India Belagavi ----- 12)DR. RITIHA UPPIN Address of Applicant :Dr. Prabhakar Kore Basic Science Research Centre, KLE Academy of Higher Education and Research, Belagavi- 590010, Karnataka, India Belagavi -----</p>
---	--

(57) Abstract :
The present invention relates to the development of a gel-based intracanal medicament formulation using extracts of Achyranthes aspera (Apamarga roots) and Trachyspermum ammi (Ajwain seeds) for reducing the facultative anaerobic bacteria especially Enterococcus faecalis in root canal treatment of adult permanent teeth. The invention also pertains to the development of a process for the preparation of a gel formulation comprising cellulosic material and extracts of Achyranthes aspera (Apamarga) and Trachyspermum ammi (Ajwain). The intracanal gel formulation of the present invention has effective antibacterial activity with excellent biocompatibility in both in vitro and in vivo conditions. Achyranthes aspera and Trachyspermum ammi based intracanal gel formulation has promising benefits and is useful as an intracanal medicament for overcoming bacterial resistance to synthetic agents in root canal treatment of permanent teeth.

(54) Title of the invention : A MOUTHWASH FORMULATION COMPRISING ACHYRANTHES ASPERA (APAMARGA) AND TRACHYSPERMUM AMMI (AJWAIN), A PROCESS FOR PREPARING THEREOF AND ORAL USE THEREOF

<p>(51) International classification :A61K0036210000, A61K0036634000, A61Q0011000000, A61K0036230000, A61P0001020000</p> <p>(86) International Application No :NA Filing Date :NA</p> <p>(87) International Publication No :NA</p> <p>(61) Patent of Addition to Application Number :NA Filing Date :NA</p> <p>(62) Divisional to Application Number :NA Filing Date :NA</p>	<p>(71)Name of Applicant : 1)DR. RAM SURATH KUMAR K Address of Applicant :Department of Public Health Dentistry, KLE Vishwanath Katti Institute of Dental Sciences, KLE Academy of Higher Education and Research, Nehru Nagar, Belagavi-590010, Karnataka, India Belagavi ----- 2)DR. ANIL V. ANKOLA 3)MRS. KISHORI P. SUTAR 4)DR. ATREY JAGDISH PAI KHOT Name of Applicant : NA Address of Applicant : NA (72)Name of Inventor : 1)DR. ROOPALI M. SANKESHWARI Address of Applicant :Department of Public Health Dentistry, KLE Vishwanath Katti Institute of Dental Sciences, KLE Academy of Higher Education and Research, Nehru Nagar, Belagavi-590010, Karnataka, India Belagavi ----- 2)DR. RAM SURATH KUMAR K Address of Applicant :Department of Public Health Dentistry, KLE Vishwanath Katti Institute of Dental Sciences, KLE Academy of Higher Education and Research, Nehru Nagar, Belagavi-590010, Karnataka, India Belagavi ----- 3)DR. APURVA PRASHANT DESHPANDE Address of Applicant :Department of Public Health Dentistry, KLE Vishwanath Katti Institute of Dental Sciences, KLE Academy of Higher Education and Research, Nehru Nagar, Belagavi-590010, Karnataka, India Belagavi ----- 4)KISHORI P. SUTAR Address of Applicant :Department of Pharmaceutics, KLE College of Pharmacy, Belagavi, KLE Academy of Higher Education and Research, Nehru Nagar, Belagavi- 590010, Karnataka, India. Belagavi ----- 5)DR. ATREY JAGDISH PAI KHOT Address of Applicant :Department of Public Health Dentistry, KLE Vishwanath Katti Institute of Dental Sciences, KLE Academy of Higher Education and Research, Nehru Nagar, Belagavi-590010, Karnataka, India Belagavi ----- 6)DR. MAHANTESH B. NAGMOTI Address of Applicant :Department of Microbiology, Jawaharlal Nehru Medical College, KLE Academy of Higher Education and Research, Belagavi- 590010, Karnataka, India Belagavi ----- 7)VISHWANATH A. JADHAV Address of Applicant :Department of Pharmaceutics, KLE College of Pharmacy, KLE Academy of Higher Education and Research, Belagavi-590010, Karnataka, India Belagavi ----- 8)DR. SHUSHANT IRAGONDA JIGAN Address of Applicant :Department of Microbiology, Jawaharlal Nehru Medical College, KLE Academy of Higher Education and Research, Belagavi-590010, Karnataka, India Belagavi ----- 9)DR. ANIL V. ANKOLA Address of Applicant :Department of Public Health Dentistry, KLE Vishwanath Katti Institute of Dental Sciences, KLE Academy of Higher Education and Research, Nehru Nagar, Belagavi-590010, Karnataka, India Belagavi ----- 10)DR. SAGAR JALIHAL Address of Applicant :Department of Public Health Dentistry, KLE Vishwanath Katti Institute of Dental Sciences, KLE Academy of Higher Education and Research, Nehru Nagar, Belagavi-590010, Karnataka, India Belagavi ----- 11)DR. RITIHA UPPIN Address of Applicant :Dr. Prabhakar Kore Basic Science Research Centre, KLE Academy of Higher Education and Research, Belagavi- 590010, Karnataka, India Belagavi -----</p>
<p>(57) Abstract : The present invention relates to the development of a mouthwash formulation comprising extracts of Achyranthes aspera (Apamarga roots) and Trachyspermum ammi (Ajwain seeds) and process of preparing thereof. The mouthwash of the present invention helps reduce the facultative anaerobic periodontal pathogens like Porphyromonas gingivalis, Tannerella forsythia and Aggregatibacter actinomycetemcomitans and helps in the management of the plaque-induced gingivitis, gingival health and plaque control in children.</p>	



Intellectual
Property
Office

Certificate of Registration for a UK Design

Design number: 6300688

Grant date: 31 August 2023

Registration date: 01 August 2023

This is to certify that,

in pursuance of and subject to the provision of Registered Designs Act 1949, the design of which a representation or specimen is attached, had been registered as of the date of registration shown above in the name of

Dr. Ashish M. Kandalkar, Mr. Anup Mukund Akarte, Dr. Somkant Vasant

Jawarkar, Dr. Kusum S Akki, Prof. (Dr). Vinod Kumar Tiwari, Prof. (Dr.) Abhijit

Narayanrao, Mr. Rakesh Subhash Dhole, Mr. Pritam Idram Pawara, Mr. Rajesh

Damu Ahire, Dr. Sachinkumar Madhukar Mahajan

in respect of the application of such design to:

Transdermal Patch Incorporating Herbal Permeation Enhancer for Metformin

Delivery

International Design Classification:

Version: 14-2023

Class: 24 MEDICAL AND LABORATORY EQUIPMENT

Subclass: 04 MATERIALS FOR DRESSING WOUNDS, NURSING AND MEDICAL CARE



Adam Williams

Adam Williams

Comptroller-General of Patents, Designs and Trade Marks

Intellectual Property Office

The attention of the Proprietor(s) is drawn to the important notes overleaf.



ORIGINAL
क्रम सं./ Serial No. : 140104



पेटेंट कार्यालय, भारत सरकार | The Patent Office, Government Of India

डिजाइन के पंजीकरण का प्रमाण पत्र | Certificate of Registration of Design

डिजाइन सं. / Design No. : 384243-001

तारीख / Date : 19/04/2023

पारस्परिकता तारीख / Reciprocity Date* :

देश / Country

प्रमाणित किया जाता है कि संलग्न प्रति में वर्णित डिजाइन जो **LABORATORY WATER MAZE APPARATUS FOR MONITORING NEUROTOXIC ACTIVITY** से संबंधित है, का पंजीकरण, श्रेणी 24-01 में 1.Pankaj Kumar Sharma 2. Dr Shaista Omer 3.Dr. Pavan Kumar Padarthi 4.Dr. Anson S Maroky 5.Dr. Mukesh Nandave 6.Dr Nayyar Parvez 7.Prof. Manoj Bisht 8.Sunil Kumar 9.Mr. Santosh Basavaraj Patil के नाम में उपर्युक्त संख्या और तारीख में कर लिया गया है।

Certified that the design of which a copy is annexed hereto has been registered as of the number and date given above in class 24-01 in respect of the application of such design to **LABORATORY WATER MAZE APPARATUS FOR MONITORING NEUROTOXIC ACTIVITY** in the name of 1.Pankaj Kumar Sharma 2. Dr Shaista Omer 3.Dr. Pavan Kumar Padarthi 4.Dr. Anson S Maroky 5.Dr. Mukesh Nandave 6.Dr Nayyar Parvez 7.Prof. Manoj Bisht 8.Sunil Kumar 9.Mr. Santosh Basavaraj Patil.

डिजाइन अधिनियम, 2000 तथा डिजाइन नियम, 2001 के अधधीन प्रावधानों के अनुसरण में।

In pursuance of and subject to the provisions of the Designs Act, 2000 and the Designs Rules, 2001.

जारी करने की तिथि : 03/07/2023
Date of Issue :



[Signature]

महानियंत्रक पेटेंट, डिजाइन और व्यापार चिह्न
Controller General of Patents, Designs and Trade Marks

*पारस्परिकता तारीख (यदि कोई हो) जिसकी अनुमति दी गई है तथा देश का नाम। डिजाइन का स्वत्वधिकार पंजीकरण की तारीख से दस वर्षों के लिए होगा जिसका विस्तार, अधिनियम एवं नियम के निबंधनों के अधीन, पाँच वर्षों की अतिरिक्त अवधि के लिए किया जा सकेगा। इस प्रमाण पत्र का उपयोग विधिक कार्यवाहियों अथवा विदेश में पंजीकरण प्राप्त करने के लिए नहीं हो सकता है।

The reciprocity date (if any) which has been allowed and the name of the country. Copyright in the design will subsist for ten years from the date of Registration, and may under the terms of the Act and Rules, be extended for a further period of five years. This Certificate is not for use in legal proceedings or for obtaining registration abroad.



Intellectual
Property
Office

Certificate of Registration for a UK Design

Design number: 6305800

Grant date: 05 September 2023

Registration date: 25 August 2023

This is to certify that,

in pursuance of and subject to the provision of Registered Designs Act 1949, the design of which a representation or specimen is attached, had been registered as of the date of registration shown above in the name of

MANJUNATH DAMMALLI , Mr. Santosh Basavaraj Patil, Mr. Vinayak Sahebrao

Mundhe , Dr. Sujith Thomas, Dr. Talluri Rameshwari Kote Ranganna , Mr.

Muruganantham Selvakumar, Dr. Deepak Adivappa Yaraguppi, Dr. Zabin

Kutubuddin Bagewadi, Dr. Ninganagouda Ramappa Patil, Dr. Ram Singh

Bishnoi, Limbachiya Jimmy Mayurdhvaj

in respect of the application of such design to:

Apparatus for measuring Hydrophilic–Lipophilic Balance (HLB) Value of

Surfactants

International Design Classification:

Version: 14-2023

Class: 10 CLOCKS AND WATCHES AND OTHER MEASURING
INSTRUMENTS, CHECKING AND SIGNALLING INSTRUMENTS

Subclass: 04 OTHER MEASURING INSTRUMENTS, APPARATUS AND
DEVICES

Adam Williams

Comptroller-General of Patents, Designs and Trade Marks
Intellectual Property Office

The attention of the Proprietor(s) is drawn to the important notes overleaf.



(54) Title of the invention : PHYSIOPATHOLOGIC MECHANISMS AND THERAPEUTIC TARGETS OF ISOCITRATE DEHYDROGENASE MUTATIONS IN HUMAN CANCER

(51) International classification :A61P 350000, C07D 952600, C12N 090400, C12Q 013200, C12Q 016886
 (86) International Application No :NA
 Filing Date :NA
 (87) International Publication No :NA
 (61) Patent of Addition to Application Number :NA
 Filing Date :NA
 (62) Divisional to Application Number :NA
 Filing Date :NA

(71)Name of Applicant :
 1)Dr. Shaily Chaudhary
 Address of Applicant :Professor & Principal, Compfeeders Aisect College of Professional Studies Pharmacy College, CAT Road, Rangwasa, Indore, Madhya Pradesh, Pin Code: 453331 -----
 2)Mr. Mohit Chadha
 3)Mr. Pathan Mujahed Nasir
 4)Dr. Malakapogu Ravindra Babu
 5)Dr. S. K. Nimbal
 6)Dr. Neelakanth M. Jeedi
 7)Ms. Neha Goel
 8)Dr. Dau Lal Bohra
 9)Dr. Palakurthi Yanadaiah
 10)Mr. Virendra Kumar Singh
 11)Mr. Mohd Salman
 12)Mr. Rajesh Kumar
 Name of Applicant : NA
 Address of Applicant : NA
 (72)Name of Inventor :
 1)Dr. Shaily Chaudhary
 Address of Applicant :Professor & Principal, Compfeeders Aisect College of Professional Studies Pharmacy College, CAT Road, Rangwasa, Indore, Madhya Pradesh, Pin Code: 453331 -----
 2)Mr. Mohit Chadha
 Address of Applicant :Assistant Professor, Baba Farid College of Pharmacy, Morkarima, Mullanpur, Ludhiana Punjab-142023 -----
 3)Mr. Pathan Mujahed Nasir
 Address of Applicant :Principal, JGVVSS Supriya College of Pharmacy, Tembhuri Tq Jafrabad, Jalna, Maharashtra, Pin Code - 431206 -----
 4)Dr. Malakapogu Ravindra Babu
 Address of Applicant :Professor, Department of Pharmaceutics School of Pharmaceutical Sciences Lovely Professional University, Jalandhar-Delhi G.T. Road, Phagwara, Punjab (India) -144411 -----
 5)Dr. S. K. Nimbal
 Address of Applicant :Professor, Department of Pharmacology KLE College of Pharmacy, Vidyanagar, Hubli - 580031, Karnataka, A Constituent Unit of KLE Academy of Higher Education and Research, Belagavi, Dharwad, Karnataka, India. -----
 6)Dr. Neelakanth M. Jeedi
 Address of Applicant :Associate Professor Department of Pharmacology KLE College of Pharmacy, Vidyanagar, Hubballi - 580031, Karnataka, A Constituent Unit of KLE Academy of Higher Education and Research, Belagavi, Dharwad, Karnataka, India. -----
 7)Ms. Neha Goel
 Address of Applicant :Associate Professor Department of Pharmacy AKS University, Satna, Madhya Pradesh Pin Code: 485001 -----
 8)Dr. Dau Lal Bohra
 Address of Applicant :Head, Department of Zoology, Seth Gyaniram Banshidhar Podar College Nawalgarh Jhunjhunu Rajasthan, India, Pin Code 333042 -----
 9)Dr. Palakurthi Yanadaiah
 Address of Applicant :Assistant Professor, Lovely Institute of Technology (Pharmacy), Lovely Professional University, Jalandhar-Delhi G.T. Road, Phagwara, Kapurthala, Punjab (India) -144411 -----
 10)Mr. Virendra Kumar Singh
 Address of Applicant :Associate Professor B.N College of Pharmacy, Nh-24, Bakshi Ka Talab, Sitapur Road, Lucknow Pin Code: 226022 -----
 11)Mr. Mohd Salman
 Address of Applicant :Lecturer Jeevan Gopi Institute of Pharmacy & Technology Ahera, Baghpat, Uttar Pradesh Pin Code: 250609 --
 12)Mr. Rajesh Kumar
 Address of Applicant :Associate Professor Narayan Institute of Pharmacy (NIOP) Gopal Narayan Singh University Jamuhar, Sasaram, Bihar - 821305 -----

(57) Abstract :
 PHYSIOPATHOLOGIC MECHANISMS AND THERAPEUTIC TARGETS OF ISOCITRATE DEHYDROGENASE MUTATIONS IN HUMAN CANCER The nanoparticle is coated with maleimide-terminated polyethylene glycol chains for attachment of the plurality of alpha-MSH peptide ligands, wherein at least one alpha-MSH peptide ligand is attached to a maleimide-terminated polyethylene glycol chain thru a thiol organization of a cysteine linker. A technique for detecting isocitrate dehydrogenase mutation, comprising measuring at least one decided-on from the institution along with trans-glutaconic acid and citraconic acid. A dye having an oxidized state and a discounted country, wherein the decreased nation can be distinguished from the oxidized state and in which the dye is initially present inside the oxidized state. The approach incorporates administering to the difficulty a therapeutically effective quantity of the inhibitor of LDHA or the activator of L-2-hydroxyglutarate dehydrogenase. DNA demethylating agent for use in a technique of treating a hematologic malignancy, comprising administering to a subject the mutant isocitrate dehydrogenase.

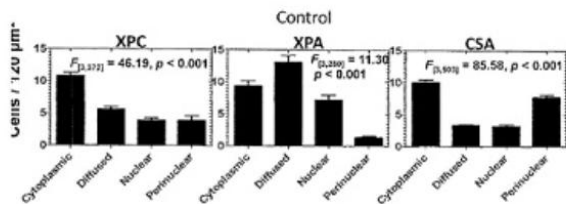


FIG. 1

No. of Pages : 16 No. of Claims : 1

पेटेंट कार्यालय
शासकीय जर्नल

**OFFICIAL JOURNAL
OF
THE PATENT OFFICE**

निर्गमन सं. 35/2023
ISSUE NO. 35/2023

शुक्रवार
FRIDAY

दिनांक: 01/09/2023
DATE: 01/09/2023

पेटेंट कार्यालय का एक प्रकाशन
PUBLICATION OF THE PATENT OFFICE

(54) Title of the invention : HERBAL COMPOSITION FOR MANAGEMENT OF NEUROLOGICAL DISORDERS

(51) International classification :A61K0036810000, A61K0036906600, A61P0025000000, A61K0036820000, A61K0036680000

(86) International Application No :NA
 Filing Date :NA

(87) International Publication No : NA

(61) Patent of Addition to Application Number :NA
 Filing Date :NA

(62) Divisional to Application Number :NA
 Filing Date :NA

(71)Name of Applicant :
1)Dr. Vishal Shrivastava
 Address of Applicant :School Of pharmacy, LNCT UNIVERSITY, Bhopal, Madhya Pradesh- 462022, India Bhopal -----
2)Dr. K.Gouri Sankar
3)Dr. Monika
4)Harish K H
5)Dr. V. Ragini
6)Dr. Rajagopalan Ramanathan
7)Dr. Karnail Singh
8)B. Anilkumar
9)Dr. Rohtash Singh
10)Dr. Satisha Hegde
11)Deepesh chouhan
 Name of Applicant : NA
 Address of Applicant : NA
 (72)Name of Inventor :
1)Dr. Vishal Shrivastava
 Address of Applicant :School Of pharmacy, LNCT UNIVERSITY, Bhopal, Madhya Pradesh- 462022, India Bhopal -----
2)Dr. K.Gouri Sankar
 Address of Applicant :Professor-Pharmacognosy , Vasantidevi patil institute of pharmacy Kodoli , Kodoli, Tal:Panhala, Kolhapur, Maharashtra-416114, India Kolhapur -----
3)Dr. Monika
 Address of Applicant :Associate Professor, Noida Institute of engineering and Technology, (Pharmacy Institute) Greater Noida knowledge park 2, Uttar Pradesh-201310, India Noida ----
4)Harish K H
 Address of Applicant :Associate Professor, Department of Pharmaceutics, KLE College of Pharmacy, Hubballi, Karnataka- 580031, India Hubballi -----
5)Dr. V. Ragini
 Address of Applicant :H.O.D and professor, dept of pharmacology, Mahathi College of pharmacy, CTM cross , madanapalli, Andhra Pradesh-517234, India madanapalli -----
6)Dr. Rajagopalan Ramanathan
 Address of Applicant :Associate Professor, Department of Pharmaceutics, Periyar College of Pharmaceutical Sciences, Periyar Centenary Educational Complex, Sathanur Main Road, Tiruchirappalli, Tamil Nadu - 620 021, India Tiruchirappalli -----
7)Dr. Karnail Singh
 Address of Applicant :Janta College of Pharmacy, Butana (Sonepat) Haryana-131302, India Sonepat -----
8)B. Anilkumar
 Address of Applicant :Assistant Professor, Department of Veterinary Pharmacology and Toxicology, College of veterinary science, PV Narsimha Rao Telangana Veterinary University, Rajendra nagar, Hyderabad, Telangana- 500030, India Hyderabad -----
9)Dr. Rohtash Singh
 Address of Applicant :Assistant Professor, Janta College of Pharmacy, Butana, Sonepat, Haryana-131302, India Sonepat -----
10)Dr. Satisha Hegde
 Address of Applicant :KLE Academy of Higher Education and Research, Dr. Prabhakar Kore Basic Science Research Centre, Belagavi, Karnataka- 590009, India Belagavi -----
11)Deepesh chouhan
 Address of Applicant :Vice principal, Dr. Tandon pharmacy college NH-11, Vill- singarpur, Fatehpur sikri road , kiraoli, Agra, Uttar Pradesh- 283122, India Agra -----

(57) Abstract :
 The present invention discloses a herbal composition designed for the management of neurological disorders. The composition comprises specific herbal extracts, including Ginkgo Biloba Extract, Bacopa Monnieri Extract, Ashwagandha Extract, Turmeric Extract, and Green Tea Extract. These extracts have been carefully selected based on their well-documented neuroprotective, cognitive-enhancing, anti-inflammatory, and antioxidant properties. The composition addresses the limitations of existing solutions by offering a holistic approach that targets multiple aspects of neurological disorders.

No. of Pages : 17 No. of Claims : 8



Office of the Controller General of Patents, Designs & Trade Marks
 Department of Industrial Policy & Promotion,
 Ministry of Commerce & Industry,
 Government of India

(<http://ipindia.nic.in/index.htm>)



(<http://ipindia.nic.in/index.htm>)

Application Details

APPLICATION NUMBER	202341065418
APPLICATION TYPE	ORDINARY APPLICATION
DATE OF FILING	29/09/2023
APPLICANT NAME	1 . Dr. Pradeep Kumar M. R. 2 . Dr. Jose Gnana Babu 3 . Dr. Prabha Thangavelu 4 . Dr. Adlin Jino Nesalin 5 . Dr. Manjoor Ahamad Syed 6 . Dr. Rajesh D Hunashal
TITLE OF INVENTION	DESIGN, SYNTHESIS, IN-VITRO AND IN-SILICO SCREENING OF NOVEL 1,3,4-OXADIAZOLE DERIVATIVES FOR ANTI-MYCOBACTERIAL ACTIVITY
FIELD OF INVENTION	BIO-CHEMISTRY
E-MAIL (As Per Record)	info@lexgin.com
ADDITIONAL-EMAIL (As Per Record)	
E-MAIL (UPDATED Online)	
PRIORITY DATE	
REQUEST FOR EXAMINATION DATE	--
PUBLICATION DATE (U/S 11A)	20/10/2023

Application Status

पेटेंट कार्यालय
शासकीय जर्नल

**OFFICIAL JOURNAL
OF
THE PATENT OFFICE**

निर्गमन सं. 39/2023
ISSUE NO. 39/2023

शुक्रवार
FRIDAY

दिनांक: 29/09/2023
DATE: 29/09/2023

पेटेंट कार्यालय का एक प्रकाशन
PUBLICATION OF THE PATENT OFFICE

(12) PATENT APPLICATION PUBLICATION

(21) Application No.202321054371 A

(19) INDIA

(22) Date of filing of Application :13/08/2023

(43) Publication Date : 29/09/2023

(54) Title of the invention : PHYTOCHEMICAL INVESTIGATION PHARMACOLOGICAL ASSESSMENT, AND FORMULATION DESIGN OF SELECT PLANTS FOR THEIR ANTI-DIABETIC ACTIVITY

<p>(51) International classification :A61K0036590000, A61P0003100000, A61K0036390000, A61K0036906600, A61K0036270000</p> <p>(86) International Application No :NA Filing Date :NA</p> <p>(87) International Publication No : NA</p> <p>(61) Patent of Addition to Application Number :NA Filing Date :NA</p> <p>(62) Divisional to Application Number :NA Filing Date :NA</p>	<p>(71)Name of Applicant : 1)Dr. Sachinkumar Madhukar Mahajan Address of Applicant :Associate professor, Institute of Pharmaceutical Education Boradi, Shirpur, Dhule, Maharashtra, Pin Code: 425405 Shirpur -----</p> <p>Name of Applicant : NA Address of Applicant : NA</p> <p>(72)Name of Inventor : 1)Dr. Sachinkumar Madhukar Mahajan Address of Applicant :Associate professor, Institute of Pharmaceutical Education Boradi, Shirpur, Dhule, Maharashtra, Pin Code: 425405 Shirpur -----</p> <p>2)Dr. Dheeraj T Baviskar Address of Applicant :Professor and Principal, P.R.I.T.s Tukaramsheth Baviskar Institute of Pharmaceutical Education and Research, Shirpur, Dhule, Maharashtra, Pin Code: 425405 Shirpur -----</p> <p>3)Dr. Javesh Kashinath Patil Address of Applicant :Associate professor, P.S.G.V.P. Mandal's College of Pharmacy, Shahada, Nandurbar, Maharashtra, Pin Code: 425409 Shahada -----</p> <p>4)Dr. Somkant Vasant Jawarkar Address of Applicant :Principal, S.D. Patil Institute of Pharmacy, Islampur, Maharashtra, Pin Code: 415409 Islampur -----</p> <p>5)Mr. Tushar Kishor Sambre Address of Applicant :Yashodhara Bajaj College of Pharmacy, Bangali Camp Mul Road, Chandrapur, Maharashtra, Pin Code: 442401 Chandrapur -----</p> <p>6)Dr. Kusum S Akki Address of Applicant :Professor, KLE College of Pharmacy, Vidyanagar, Hubballi, Dharwad, Karnataka, Pin Code: 580031 Hubballi -----</p> <p>7)Prof. Swati Ramchandra Fulmali Address of Applicant :Associate Professor, SGSPS, Institute of Pharmacy, Akola, Maharashtra, Pin Code: 444004 Akola -----</p> <p>---</p>
---	---

(57) Abstract :

The present invention relates to the A polyherbal suspension containing extracts from Curcuma caesia, Evolvulus alsinoide, Citrullus lanatus, Gymnema sylvestre, Tinospora cordifolia, Withania coagulans, and Caesalpinia bonduc was formulated to harness their combined potential. Phytochemical analysis confirmed the presence of glycosides, triterpenoids, flavonoids, saponins, alkaloids, and steroids. Stability studies, microbial tests, and heavy metal analysis demonstrated formulation safety. Antidiabetic efficacy was assessed in Alloxan-induced diabetic rats and oral glucose tolerance tests. Notably, the polyherbal formulation showed significant reductions in blood glucose levels, particularly in doses PHF 2(B) (200 mg/kg) and PHF 3(C) (400 mg/kg). Histopathological analysis of pancreatic tissues revealed architectural recovery. The formulation also displayed lipid-lowering activity, including decreased total cholesterol, triglycerides, SGPT, SGOT, and increased HDL levels. These findings suggest the polyherbal suspension's safety and potential as an effective antidiabetic treatment.

No. of Pages : 29 No. of Claims : 4



Intellectual
Property
Office

Certificate of Registration for a UK Design

Design number: 6327950

Grant date: 29 November 2023

Registration date: 22 November 2023

This is to certify that,

in pursuance of and subject to the provision of Registered Designs Act 1949, the design of which a representation or specimen is attached, had been registered as of the date of registration shown above in the name of

Dr. Ghanshyam Magan Chavan, Dr. Navjot Karwar, Dr. Mahesh Kumar Posa,

Dr. Laxmi Pattanashetti, Dharmasa Pawar, Mr. Kore Kakasaheb Jagannath, Mr.

Piyush Kiran Chavan, Mr. Amit Dilip Patil, Dr. RumiKumar Maheshchandra

Shah, Viraj Vithal Kulkar

in respect of the application of such design to:

Infusion Pump Apparatus for Liposome based encapsulated drug delivery for the treatment of cancer

International Design Classification:

Version: 14-2023

Class: 24 MEDICAL AND LABORATORY EQUIPMENT

Subclass: 01 APPARATUS AND EQUIPMENT FOR DOCTORS, HOSPITALS AND LABORATORIES

Adam Williams

Comptroller-General of Patents, Designs and Trade Marks
Intellectual Property Office

The attention of the Proprietor(s) is drawn to the important notes overleaf.





US 20230115335A1

(19) **United States**
(12) **Patent Application Publication**
Aguilera et al.

(10) **Pub. No.: US 2023/0115335 A1**
(43) **Pub. Date: Apr. 13, 2023**

(54) **PYRAZOLE DERIVATIVES WITH ANTICANCER ACTIVITY**
(71) Applicants **BOARD OF REGENTS, THE UNIVERSITY OF TEXAS SYSTEM, Austin, TX (US); THE REGENTS OF THE UNIVERSITY OF CALIFORNIA, Oakland, CA (US)**

A61P 35/02 (2006.01)
A61P 35/00 (2006.01)
A61K 45/06 (2006.01)
A61K 31/416 (2006.01)
A61K 31/5377 (2006.01)
A61K 31/454 (2006.01)
A61K 31/4192 (2006.01)

(72) Inventors: **Renato J. Aguilera, El Paso, TX (US); Subhas S. Karki, El Paso, TX (US); Subject Kumar, El Paso, TX (US); Manuel L. Penichet, Los Angeles, CA (US)**

(52) **U.S. CL**
CPC *C07D 403/12* (2013.01); *C07D 231/54* (2013.01); *C07D 405/14* (2013.01); *A61P 35/02* (2018.01); *A61P 35/00* (2018.01); *A61K 45/06* (2013.01); *A61K 31/416* (2013.01); *A61K 31/5377* (2013.01); *A61K 31/454* (2013.01); *A61K 31/4192* (2013.01)

(21) Appl. No.: 17/964,110

(57) **ABSTRACT**

(22) Filed: **Oct. 12, 2022**

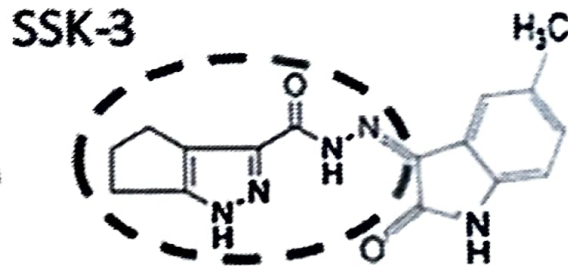
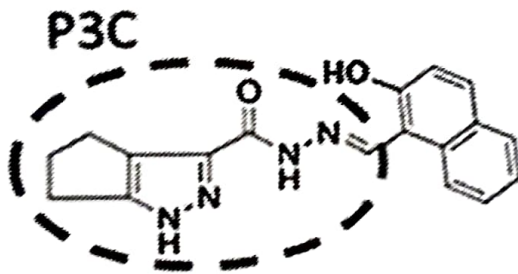
Related U.S. Application Data

(60) Provisional application No. 63/254,899, filed on Oct. 12, 2021.

The inventors have used a differential nuclear staining (DNS) assay to discover compounds with cytotoxic activity against the CEM cell line that has been determined to be highly sensitive to a variety of anti-cancer compounds. Compounds were synthesized based on a pyrazole backbone structure. Several newly synthesized compounds have been tested to identify the compounds with highest activity. One compound identified is the SSK-3 compound which has been tested on cancer cell lines and determined that it induced apoptosis via phosphatidylserine membrane exposure and activation of caspase 3 in the CEM lymphoma cell line.

Publication Classification

(51) **Int. CL**
C07D 403/12 (2006.01)
C07D 231/54 (2006.01)
C07D 405/14 (2006.01)




Principal
KLE College of Pharmacy
Bengaluru-560 010



ORIGINAL

मूल/No : 133316



भारत सरकार
GOVERNMENT OF INDIA
पेटेंट कार्यालय
THE PATENT OFFICE

डिजाइन के पंजीकरण का प्रमाणपत्र
CERTIFICATE OF REGISTRATION OF DESIGN

डिजाइन सं. / Design No : 376105-001
तारीख / Date : 24/12/2022
पारस्परिकता तारीख / Reciprocity Date* :
देश / Country :

प्रमाणित किया जाता है कि संलग्न प्रति में वर्णित डिजाइन जो **PATIENT INTERFACE ASSEMBLY FOR RESPIRATORY** से संबंधित है, का पंजीकरण, श्रेणी 24-01 में 1.Kalavati Jambigi 2. J.Swathi 3.A.Shailaja 4.Polepaka Kavitha Baburao के नाम में उपर्युक्त संख्या और तारीख में कर लिया गया है।

Certified that the design of which a copy is annexed hereto has been registered as of the number and date given above in class 24-01 in respect of the application of such design to **PATIENT INTERFACE ASSEMBLY FOR RESPIRATORY** in the name of 1.Kalavati Jambigi 2. J.Swathi 3.A.Shailaja 4.Polepaka Kavitha Baburao.

डिजाइन अधिनियम, 2000 तथा डिजाइन नियम, 2001 के अध्वधीन प्रावधानों के अनुसरण में।

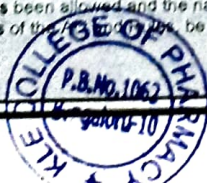
In pursuance of and subject to the provisions of the Designs Act, 2000 and the Designs Rules, 2001.

निर्गमन की तारीख/Date of issue : 18/04/2023

महानियंत्रक, पेटेंट, डिजाइन और व्यापार चिह्न
Controller General of Patents, Designs and Trade Marks

पारस्परिकता तारीख (यदि कोई हो) जिसकी अनुमति देश के नाम पर की गई है। डिजाइन का सर्वाधिकार पंजीकरण की तारीख से दस वर्षों के लिए होगा जिसका विस्तार, अधिनियम एवं नियम के निबंधनों के अधीन, पाँच वर्षों की अतिरिक्त अवधि के लिए किया जा सकेगा। इस प्रमाण पत्र का उपयोग विधिक कार्यवाहियों अथवा विदेश में पंजीकरण प्राप्त करने के लिए नहीं हो सकता है।

*The reciprocity date (if any) which has been allowed and the name of the country Copyright in the design will subsist for ten years from the date of Registration, and may under the terms of the Act be extended for a further period of five years. This Certificate is not for use in legal proceedings or for obtaining registration abroad.



KLE College of Pharmacy
Bengaluru-560 010

Certificate of Registration for a UK Design

Design number: 6274705

Grant date: 19 April 2023

Registration date: 08 April 2023

This is to certify that,

in pursuance of and subject to the provision of Registered Designs Act 1949, the design of which a representation or specimen is attached, had been registered as of the date of registration shown above in the name of

Dr. Anasuya Patil, Dr. Mohd Ruman Khan, Dr. Muneeb U Rehman, Dr. Showkat

Ul Nabl, Ms. Payal Anil Pansare, Mr. Mohammad Muztaba, Dr. Mohammed

Salman, Mr. Brijesh Kumar Saroj, Ms. Reema Bansal, Mrs. Namrata Sanjay

Mane

in respect of the application of such design to:

Fluid Transfer Apparatus for Medical Purpose

International Design Classification:

Version: 14-2023

Class: 24 MEDICAL AND LABORATORY EQUIPMENT

Subclass: 01 APPARATUS AND EQUIPMENT FOR DOCTORS, HOSPITALS AND LABORATORIES

Version: 14-2023

Class: 24 MEDICAL AND LABORATORY EQUIPMENT

Subclass: 02 MEDICAL INSTRUMENTS, INSTRUMENTS AND TOOLS FOR LABORATORY USE

Adam Williams



Adam Williams

Comptroller-General of Patents, Designs and Trade Marks

Intellectual Property Office

The attention of the Proprietor(s) is drawn to the important notes overleaf.



(12) PATENT APPLICATION PUBLICATION

(21) Application No. 202321024285 A

(19) INDIA

(22) Date of filing of Application : 30/03/2023

(43) Publication Date : 05/05/2023

(54) Title of the invention : FABRICATION OF LIPID BASED NANOCARRIER DRUG DELIVERY FOR AN ANTIBIOTICS

(51) International classification: A61K 090000, A61K 091070, A61K 091270, A61K 095100, A61K 313550
 (56) International Application No: NA
 Filing Date: NA
 (57) International Publication No: NA
 (61) Patent of Addition to Application Number: NA
 Filing Date: NA
 (62) Divisional to Application Number: NA
 Filing Date: NA

(71) Name of Applicant :
 1) Mr. Farhan Mujahed Khan Nadeer Khan
 Address of Applicant: Principal, K.V.V.S.S.S College of Pharmacy, Tambhurna TQ Jafarabad, Jalna-431206, Maharashtra, India Jalna
 2) Dr. Jameel Ahmad R. Mulla
 3) Dr. Anasuya Patil
 4) Madhva Arvind Joshi
 5) Amundoop Kaur
 6) Mohit Chhabra
 7) Arun Prakash
 8) Sonam Pandey
 9) Prateek Kumar
 10) Amol Dilip Ghelap
 11) Syed Anwar Ahmed
 12) Rajarshi Nath
 Name of Applicant : NA
 Address of Applicant : NA
 (72) Name of Inventor :
 1) Mr. Farhan Mujahed Khan Nadeer Khan
 Address of Applicant: Principal, K.V.V.S.S.S College of Pharmacy, Tambhurna TQ Jafarabad, Jalna-431206, Maharashtra, India Jalna
 2) Dr. Jameel Ahmad R. Mulla
 Address of Applicant: Professor, Shree Sanjivani College of Pharmacy, Chigagan, Shivaji nagar (Chigagan), Karad, Solapur-415111, Maharashtra, India, Solapur
 3) Dr. Anasuya Patil
 Address of Applicant: Associate Professor, K.J.S.O College of Pharmacy, II Block Rajajinagar, Bengaluru-560015, Karnataka, India Bengaluru
 4) Madhva Arvind Joshi
 Address of Applicant: Assistant Professor, IVN's Indrayani Institute of Pharmaceutical Education & Research, Talegaon, Chakan road, Dehade Pune-410507, Maharashtra, India, Pune
 5) Amundoop Kaur
 Address of Applicant: Assistant Professor, Amar Shahood Baba Ajit Singh Jujhar Singh Memorial College of Pharmacy, Deth. Ropar-140001, Punjab, India, Ropar
 6) Mohit Chhabra
 Address of Applicant: Assistant Professor, Baba Farid College of Pharmacy, Multanpur, Ludhiana-142023, Punjab, India, Ludhiana
 7) Arun Prakash
 Address of Applicant: Associate Professor, Shree Krishna College of Pharmacy, Sitapur, Lucknow-226020, Uttar Pradesh, India Lucknow
 8) Sonam Pandey
 Address of Applicant: Assistant Professor, Sath Vishambhar Nath Institute of pharmacy, Khazur Gan, Lucknow-225003, Uttar Pradesh, India, Lucknow
 9) Prateek Kumar
 Address of Applicant: Assistant Professor, Shree Krishna College of Pharmacy, Sitapur, Lucknow-226020, Uttar Pradesh, India, Lucknow
 10) Amol Dilip Ghelap
 Address of Applicant: Assistant Professor, Department of Pharmaceutics, St. John Institute of Pharmacy and Research Palghar, A.E.I limited to University of Mumbai, Palghar-401404, Maharashtra, India, Palghar
 11) Syed Anwar Ahmed
 Address of Applicant: Assistant Professor, S.S.S Indira College of Pharmacy Sahayog Campus, Vishnupuri, Nanded-431606, Maharashtra, India, Nanded
 12) Rajarshi Nath
 Address of Applicant: Assistant Professor, Bharat Technology, Uluberia, Howrah-711316, West Bengal, India, Howrah

(57) Abstract:
 ABSTRACT FABRICATION OF LIPID BASED NANOCARRIER DRUG DELIVERY FOR AN ANTIBIOTICS Lipid-based nanocarriers have been extensively investigated for drug delivery due to their advantages including biodegradability, biocompatibility, non-toxicity, and non-immunogenicity. However, the shortcomings of traditional lipid-based nanocarriers such as insufficient targeting, capture by the reticuloendothelial system, and fast elimination limit the efficiency of drug delivery and therapeutic efficacy. Therefore, a series of multifunctional lipid-based nanocarriers have been developed to enhance the accumulation of drugs in the lesion site, aiming for improved diagnosis and treatment of various diseases. In this review, we summarized the advances and applications of lipid-based nanocarriers from traditional to novel functional lipid preparations, including liposomes, stimuli-responsive lipid-based nanocarriers, ionizable lipid nanoparticles, lipid hybrid nanocarriers, as well as biomembrane-camouflaged nanoparticles.

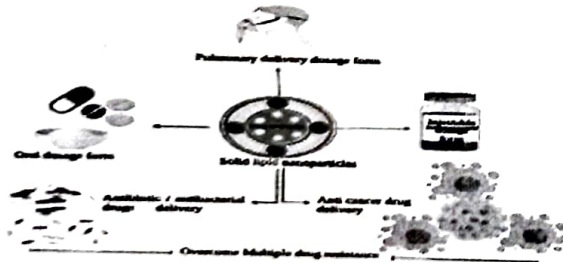


Fig.1: depicts perspectives and prospective on solid lipid nanoparticles.

No. of Pages : 16 No. of Claims : 7

The Patent Office Journal No. 18/2023 Dated 05/05/2023



34068
 Principal
 KLE College of Pharmacy,
 Bengaluru-560 010



ORIGINAL

मूल/No 137740



भारत सरकार
GOVERNMENT OF INDIA
पेटेंट कार्यालय
THE PATENT OFFICE

डिजाइन के पंजीकरण का प्रमाणपत्र
CERTIFICATE OF REGISTRATION OF DESIGN

डिजाइन सं. / Design No. : 382015-001
तारीख / Date : 21/03/2023
पारस्परिकता तारीख / Reciprocity Date* :
देश / Country :

प्रमाणित किया जाता है कि संलग्न प्रति में वर्णित डिजाइन जो **PORTABLE MUFFLE FURNACE** से संबंधित है, का पंजीकरण, श्रेणी 23-03 में 1.Dr Farhad Mehta 2. Dr. Birenkumar N. Shah 3.Dr. Anasuya Patil 4.Mohammad Amir 5.Dr. Bhavana Yadav 6.Anupam Kanti Bag के नाम में उपर्युक्त संख्या और तारीख में कर लिया गया है।

Certified that the design of which a copy is annexed hereto has been registered as of the number and date given above in class 23-03 in respect of the application of such design to **PORTABLE MUFFLE FURNACE** in the name of 1.Dr Farhad Mehta 2. Dr. Birenkumar N. Shah 3.Dr. Anasuya Patil 4.Mohammad Amir 5.Dr. Bhavana Yadav 6.Anupam Kanti Bag.

डिजाइन अधिनियम, 2000 तथा डिजाइन नियम, 2001 के अध्याधीन प्रावधानों के अनुसरण में।

In pursuance of and subject to the provisions of the Designs Act, 2000 and the Designs Rules, 2001.

निर्गमन की तारीख/Date of Issue : 24/05/2023

महानियंत्रक पेटेंट, डिजाइन और व्यापार चिह्न
Controller General of Patents, Designs and Trade Marks

पारस्परिकता सार्वभूमि (यदि कोई हो) जिसकी अनुमति देश के नाम पर की गई है। डिजाइन का सत्वाधिकार पंजीकरण की तारीख से दस वर्षों के लिए होगा जिसका विस्तार, अधिनियम एवं नियम के निर्बंधनों के अर्थान, पाँच वर्षों की अतिरिक्त अवधि के लिए किया जा सकेगा। इस प्रमाण पत्र का उपयोग विधिक कार्यवाहियों अथवा विदेश में पंजीकरण प्राप्त करने के लिए नहीं हो सकता है।

*The reciprocity date (if any) which has been allowed and the name of the country. Copyright in the design will subsist for ten years from the date of Registration, and may under the terms of the Act and Rules, be extended for a further period of five years. This Certificate is not for use in legal proceedings or for obtaining registration abroad.



KLE College of Pharmacy
Bengaluru-560 010

(54) Title of the invention : AI BASED INTERVENTIONS FOR DEVELOPING STABILITY INDICATING METHOD VALIDATION OF ANTI-INFLAMMATORY DRUG USING RP-HPLC METHOD

(51) International classification :G01N0030020000, G01N0030340000, C12N0007000000, A61P0029000000,
C07K0014005000
(86) International Application No :PCT//
Filing Date :01/01/1900
(87) International Publication No : NA
(61) Patent of Addition to Application Number :NA
Filing Date :NA
(62) Divisional to Application Number :NA
Filing Date :NA

(71)Name of Applicant :
1)P.V. Murali Krishna
Address of Applicant :Associate Professor, Department of Pharmaceutical Analysis, KLE College of Pharmacy, Rajajinagar, Bengaluru, Karnataka, India-560010 Bengaluru -----
2)A. Srikanth
3)Valikala viswanath
4)Dr. Boi Basanta kumar Reddy
5)Dr. Santikari Sesa Phanindra
6)Dr.V.Kiran Kumar
7)Bhavneet Singh
8)Dr. Nagaravile Kanthappa Sathish
9)Om Prakash Panda
10)Dr. Putta Rajesh Kumar
11)Dr. Narottam Pal
12)Zain ul Bashar Khan
Name of Applicant : NA
Address of Applicant : NA
(72)Name of Inventor :
1)P.V. Murali Krishna
Address of Applicant :Associate Professor, Department of Pharmaceutical Analysis, KLE College of Pharmacy, Rajajinagar, Bengaluru, Karnataka, India-560010 Bengaluru -----
2)A. Srikanth
Address of Applicant :Associate Professor, Department of Pharmaceutical Analysis, Vasavi Institute of Pharmaceutical Sciences, Bakarapeta, Kadapa, Andhrapradesh, India Kadapa -----
3)Valikala viswanath
Address of Applicant :Professor, Department of Pharmaceutics, Annamacharya college of pharmacy, Rajampeta, Andhrapradesh, India Rajampeta -----
4)Dr. Boi Basanta kumar Reddy
Address of Applicant :Professor, Danteswari college of pharmacy Borapadar, Raipur Road, Jagdalpur, Chhattisgarh,India - 494221 Jagdalpur -----
5)Dr. Santikari Sesa Phanindra
Address of Applicant :Associate Professor Department of Pharmaceutical Analysis, Surabhi Dayakar Rao College of Pharmacy, Rimmanaguda (Village), Gajwel (Mandal) Siddipet (District), Telangana-India-502312 Siddipet -----
6)Dr.V.Kiran Kumar
Address of Applicant :Professor & HOD, Department of Pharmaceutical Analysis, Mother Teresa College of Pharmacy, NFC Nagar, Ghatkesar, Hyderabad, Telangana, India- 501301 Hyderabad -----
7)Bhavneet Singh
Address of Applicant :Assistant Professor Department of Pharmacy Gujranwala Guru Nanak Khalsa College of Pharmacy, Civil Lines, Ludhiana, Punjab, India- 141001 Ludhiana -----
8)Dr. Nagaravile Kanthappa Sathish
Address of Applicant :Associate Professor, Department of Pharmaceutical Chemistry, Government College of Pharmacy, P.Kalingarao Road, Mission Road, Bengaluru, Karnataka, India-560027 Bengaluru -----
9)Om Prakash Panda
Address of Applicant :Assistant.Professor, Department of Pharmacy Centurion University of Technology and Management, Odisha, India, 756044 Cuttack -----
10)Dr. Putta Rajesh Kumar
Address of Applicant :Professor and Head, Department of Pharmaceutics, Akshaya Institute of Pharmacy, Lingapura, obalapura, Tumkur, Karnataka, India - 572106 Tumkur -----
11)Dr. Narottam Pal
Address of Applicant :Associate Professor, Department of Pharmaceutical Analysis, Bhaskar Pharmacy College, Yenkapally, Moinabad, Hyderabad, Telangana, India-500075 Hyderabad -----
12)Zain ul Bashar Khan
Address of Applicant :Assistant professor Department of Pharmaceutical Analysis, Bhaskar Pharmacy College, Yenkapally, Moinabad, Hyderabad, Telangana, India- 500075 Hyderabad -----

(57) Abstract :

The invention relates to an AI based interventions for developing stability indicating method validation of anti-inflammatory drug using RP-HPLC (Reverse-Phase High-Performance Liquid Chromatography) method. AI algorithms assist in the analysis of large datasets, identifying patterns, correlations, and outliers. Through the use of advanced models, AI helps in optimizing method parameters, such as mobile phase composition, gradient conditions, and temperature settings, resulting in improved separation and resolution of critical peaks.

No. of Pages : 15 No. of Claims : 7

(54) Title of the invention : SOLID DISPERSION OF AN ANTIFUNGAL DRUG IN GEL FORMULATION FOR IMPROVING BIOAVAILABILITY

<p>(51) International classification :A61K 091400, A61K 473200, A61K 473800, A61P 170000, A61P 311000</p> <p>(86) International Application No :PCT//</p> <p>Filing Date :01/01/1900</p> <p>(87) International Publication No : NA</p> <p>(61) Patent of Addition to Application Number :NA</p> <p>Filing Date :NA</p> <p>(62) Divisional to Application Number :NA</p> <p>Filing Date :NA</p>	<p>(71)Name of Applicant :</p> <p>1)Dr Kiran Kumar Y Address of Applicant :Professor & Principal Department of Pharmaceutics Gate College of Pharmaceutical sciences, Kodad,Telangana, India-508206 Kodad -----</p> <p>2)Mannam Mounika 3)Urooj Fatima Baig 4)Simin Naaz Md Kaleem 5)Farhat Fatima 6)Dimple Pirgal 7)Mr.Ismail Yusuf Shaikh 8)Parmeshwar Sudhakar Mane 9)Dr. Durga Prasad Thammisetty 10)Dr. V. T. Iswariya 11)Valikala Viswanath 12)Dr Vankam Lokeswara Babu</p> <p>Name of Applicant : NA Address of Applicant : NA</p> <p>(72)Name of Inventor :</p> <p>1)Dr Kiran Kumar Y Address of Applicant :Professor & Principal Department of Pharmaceutics Gate College of Pharmaceutical sciences, Kodad,Telangana, India-508206 Kodad -----</p> <p>2)Mannam Mounika Address of Applicant :Assistant Professor, Department of Pharmaceutics Bhaskar Pharmacy College, Yenkapally (V), Moinabad (M), Rangareddy District,Telangana,India-500075 Rangareddy -----</p> <p>3)Urooj Fatima Baig Address of Applicant :Assistant Professor, Department: Pharmaceutical Quality Assurance, Bhaskar Pharmacy College, Yenkapally (V), Moinabad (M), Rangareddy District,Telangana,India-500075 Rangareddy -----</p> <p>4)Simin Naaz Md Kaleem Address of Applicant :Assistant professor Department of Pharmacology Bhaskar pharmacy college, Yenkapally (V), Moinabad (M), Rangareddy District,Telangana, India-500075 Rangareddy -----</p> <p>5)Farhat Fatima Address of Applicant :Assistant Professor, Department of Pharmaceutical Chemistry, Bhaskar pharmacy college, Yenkapally (V), Moinabad (M), Rangareddy District,Telangana,India-500075 Rangareddy -----</p> <p>6)Dimple Pirgal Address of Applicant :Assistant Professor, Department of Pharmaceutical Chemistry, KLE College of Pharmacy, Bengaluru, Karnataka,India-560010 Bengaluru -----</p> <p>7)Mr.Ismail Yusuf Shaikh Address of Applicant :Assistant Professor, Department of Pharmaceutical Chemistry, Godavari Institute Of Pharmacy Kolpa, Latur Maharashtra, Murambi Post Sugaon Tq Chakur, District:- Latur,Maharashtra, India-413512 Latur -----</p> <p>8)Parmeshwar Sudhakar Mane Address of Applicant :Lecturer, Diploma in Pharmacy, Godavari Institute Of Pharmacy, Kolpa,Latur, Maharashtra, India, 413512 Latur -----</p> <p>9)Dr. Durga Prasad Thammisetty Address of Applicant :Associate Professor, Department of Pharmacy Practice, Sri Padmavathi School of Pharmacy, Mohan Gardens, Vyshnavi Nagar, Tiruchanoor, Tirupati, Andhra Pradesh,India-517503 Tirupati ---</p> <p>10)Dr. V. T. Iswariya Address of Applicant :Assistant Professor, Department of pharmaceutics, CMR College of Pharmacy Kandlakoya (V), Medchal Rd, Hyderabad, Telangana,India-501401 Hyderabad -----</p> <p>11)Valikala Viswanath Address of Applicant :Professor, Department of Pharmaceutics, Annamacharya college of pharmacy, Rajampeta-Andhrapradesh,India-516126 Rajampeta -----</p> <p>12)Dr Vankam Lokeswara Babu Address of Applicant :Associate Professor& HOD, Dept of Pharmaceutics, Bhaskar Pharmacy College, Yankapally (V), Moinabad (M), Rangareddy District,Telangana,India-500075 Rangareddy -----</p>
--	--

(57) Abstract :
The invention relates to a method of solid dispersion of an anti-fungal drug in gel formulation for improving bioavailability. The research in invention involved selecting an appropriate anti- fungal drug with limited water solubility and formulating a solid dispersion using a pharmaceutically acceptable polymer. Various techniques were employed to prepare the solid dispersion, ensuring a homogenous distribution of drug particles within the polymer matrix. The solid dispersion was then incorporated into a gel formulation to facilitate topical application and controlled drug release. The gel matrix provided enhanced drug solubility and dissolution, promoting improved drug absorption and bioavailability. Moreover, the gel formulation offered prolonged drug release, enabling sustained therapeutic effect and reducing systemic side effects.

No. of Pages : 14 No. of Claims : 7



Intellectual
Property
Office

Certificate of Registration for a UK Design

Design number: 6319794

Grant date: 26 October 2023

Registration date: 18 October 2023

This is to certify that,

in pursuance of and subject to the provision of Registered Designs Act 1949, the design of which a representation or specimen is attached, had been registered as of the date of registration shown above in the name of

Dr. Mamatha Achyuta, Minerva Sharma, Gauri Ulhas Bhivshet, Kajal Chaudhary,

Naishadh Solanki, Asheesh Pratap Singh, Dr. Rohini Karunakaran, Dr. Chirag

Goda, Dr. Nirmala Kumari Yadav, Shivali Rahi

in respect of the application of such design to:

AI Enabled Device for Early Detection of Cardiac Diseases

International Design Classification:

Version: 14-2023

Class: 24 MEDICAL AND LABORATORY EQUIPMENT

Subclass: 01 APPARATUS AND EQUIPMENT FOR DOCTORS, HOSPITALS
AND LABORATORIES

Adam Williams

Comptroller-General of Patents, Designs and Trade Marks

Intellectual Property Office

The attention of the Proprietor(s) is drawn to the important notes overleaf.



(12) PATENT APPLICATION PUBLICATION

(21) Application No.202241067463 A

(19) INDIA

(22) Date of filing of Application :23/11/2022

(43) Publication Date : 02/12/2022

(54) Title of the invention : **ANTIFUNGAL AND ANTIBACTERIAL ACTIVITY OF SOME FUSED FIVE MEMBERED HETEROCYCLIC COMPOUNDS**

(51) International classification :C12R0001070000, A61K0036575000, A61K0008978900, A61P0031040000, A61K0008490000
(86) International Application No :PCT//
Filing Date :01/01/1900
(87) International Publication No :NA
(61) Patent of Addition to Application Number :NA
Filing Date :NA
(62) Divisional to Application Number :NA
Filing Date :NA

(71)Name of Applicant :
1)Dr. Rameshwari Verma
Address of Applicant :Associate Professor School of Chemistry and Chemical Engineering, Yulin University, Yulin 719000, Shaanxi, P. R. China -----
2)Dr. Priyanka Kamaria
3)Mr. Dilip Tiwari
4)Mr. Tapas Panigrahi
5)Mr. Abinash Kumar Sahu
6)Dr. Saroj Kumar Raul
7)Mr. Pankaj Bhardwaj
8)Mr. Arun Kumar Singh Parihar
9)Mr. Rahul singh
10)Ms. Gitanjali Kashyap
11)Dr. Santosh Kumar Verma
12)Dr. Kadalipura P. Rakesh
Name of Applicant : NA
Address of Applicant : NA
(72)Name of Inventor :
1)Dr. Rameshwari Verma
Address of Applicant :Associate Professor School of Chemistry and Chemical Engineering, Yulin University, Yulin 719000, Shaanxi, P. R. China -----
2)Dr. Priyanka Kamaria
Address of Applicant :Assistant Professor Department of Pharmaceutical Chemistry, KLE College of Pharmacy, Bengaluru, Constituent unit of KLE Academy of higher education and research(Deemed to be University), Rajajinagar, 560010, Karnataka, India -----
3)Mr. Dilip Tiwari
Address of Applicant :Assistant Professor Shri Ram College of Pharmacy(SRCP) Bamor, Gwalior, Madhya Pradesh -----
4)Mr. Tapas Panigrahi
Address of Applicant :Associate Professor Royal College of Pharmacy, Raipur, Chhattisgarh, India -----
5)Mr. Abinash Kumar Sahu
Address of Applicant :Associate professor Department of Medicinal Chemistry, The Pharmaceutical College, Barpali, Bargarh, Odisha -----
6)Dr. Saroj Kumar Raul
Address of Applicant :Associate professor Department of Pharmaceutical Chemistry, Maharajahs College of Pharmacy, Vizianagaram, Andhra Pradesh 535002 -----
7)Mr. Pankaj Bhardwaj
Address of Applicant :Research scholar School of Pharmaceutical Sciences, Shri Guru Ram Rai University Dehradun, West Patel Nagar, Patel Nagar, Dehradun, Uttarakhand 248001 -----
8)Mr. Arun Kumar Singh Parihar
Address of Applicant :Scientific Officer (Botany/Pharmacognosy) Drugs Testing Laboratory Avum Anusandhan Kedra Raipur C.G. -----
9)Mr. Rahul singh
Address of Applicant :Assistant professor M.J. College of Pharmacy, Junwani road,Kohka,Bhilai, Chhattisgarh 490023 -----
10)Ms. Gitanjali Kashyap
Address of Applicant :Research Scholar Faculty of Pharmaceutical Sciences, Shri Shankaracharya Technical Campus, Junwani, Bhilai, Chhattisgarh, 490020 -----
11)Dr. Santosh Kumar Verma
Address of Applicant :Associate Professor School of Chemistry and Chemical Engineering, Yulin University, Yulin 719000, Shaanxi, P. R. China -----
12)Dr. Kadalipura P. Rakesh
Address of Applicant :Department of Radiology, Biomedical Research Imaging Center, University of North Carolina at Chapel Hill, Chapel Hill, North Carolina 27599, USA -----

(57) Abstract :
ANTIFUNGAL AND ANTIBACTERIAL ACTIVITY OF SOME FUSED FIVE MEMBERED HETEROCYCLIC COMPOUNDS A system for antifungal and antibacterial activity of some fused five membered heterocyclic compounds. The composition is present in the food, cosmetic, nutraceutical or pharmaceutical in a range from about 0.01% to about 20% by weight of the total weight of the food. A synthetic antimicrobial selected from the group consisting of a quaternary ammonium compound at a concentration of less than about 5% w/w, a biguanide at a concentration up to 10% w/w, and a combination thereof. The strain does not have antibacterial activity against Bacillus subtilis, Bacillus amyloliquefaciens , or a combination thereof, which is a fermented bacterium of the genus Bacillus strains. At least one enriched Magnolia extract is extracted from Magnolia plants with water, ethanol, methanol, alcohol and water mixed solvents, or by supercritical fluid. Applying at least one peptoid oligomer or a composition thereof to a surface of the environment to coat the surface, thereby generating the antiseptic or sterile environment.

No. of Pages : 16 No. of Claims : 1

The Patent Office Journal No. 48/2022 Dated 02/12/2022

76246



Principal
KLE College of Pharmacy
Bengaluru-560 010

(12) PATENT APPLICATION PUBLICATION
(19) INDIA

(21) Application No.202211066124 A

(22) Date of filing of Application :18/11/2022

(43) Publication Date : 25/11/2022

(54) Title of the invention : MODULATION OF DRUG RELEASE FROM PH-RESPONSIVE SOFT NANOCOMPOSITES

(51) International classification :A61K0009000000, A61P0035000000, A61K0009500000, A61K0009160000, A61K0031496000
(86) International Application No :NA
Filing Date :NA
(87) International Publication No : NA
(61) Patent of Addition to Application Number :NA
Filing Date :NA
(62) Divisional to Application Number :NA
Filing Date :NA

(71)Name of Applicant :

1)Prof. (Dr.) N. G. Raghavendra Rao

Address of Applicant :KIET School of Pharmacy, KIET Group of Institutions, Delhi-NCR, Muradnagar, Ghaziabad-201206, UP. Dr. A.P.J. Abdul Kalam Technical University, Lucknow, Uttar Pradesh, India

2)Dr. Gampa Vijay Kumar

3)Mr Darla Raju

4)Dr.K.Ravi Kumar

5)Dr. Krishnaraju Venkatesan

6)Dr DSNBK Prasanth

7)Dr. Vikrant Kisanrao Nikam

8)Dr. J. Priyanga

9)Mr. Pavan Kumar Krosuri

10)Mr. Adeep Kujur

11)Dr. Nivedita Biswas

12)Ms. Anjali Sinha

Name of Applicant : NA

Address of Applicant : NA

(72)Name of Inventor :

1)Prof. (Dr.) N. G. Raghavendra Rao

Address of Applicant :KIET School of Pharmacy, KIET Group of Institutions, Delhi-NCR, Muradnagar, Ghaziabad-201206, UP. Dr. A.P.J. Abdul Kalam Technical University, Lucknow, Uttar Pradesh, India

2)Dr. Gampa Vijay Kumar

Address of Applicant :Professor Department Of Pharmacy KGR Institute of Technology and Management, Rampally - 501301, India

3)Mr Darla Raju

Address of Applicant :Assistant Professor Joginpalli B R Pharmacy College Survy No 156 To 162, Amdapur X Road, Yenkapally, Moinabad, Hyderabad, Telangana -500075, India

4)Dr.K.Ravi Kumar

Address of Applicant :Associate Professor Department of Pharmaceutics Santhiram College of Pharmacy, N.H.40 Nerawada, Nandyal (Dt) Nandyal-518112

5)Dr. Krishnaraju Venkatesan

Address of Applicant :Associate Professor, Department of Pharmacology and Toxicology, College of Pharmacy, King Khalid University, Abha, KSA

6)Dr DSNBK Prasanth

Address of Applicant :Associate Professor, Department of Pharmacognosy, KVSR Siddhartha College of Pharmaceutical Sciences, Vijayawada - 520010, Andhra Pradesh, India

7)Dr. Vikrant Kisanrao Nikam

Address of Applicant :Assistant Professor, Amrutvahini College of Pharmacy, Sangamner, Tal-Sangamner, Dist- Ahmednagar, Maharashtra, Pin-422608

8)Dr. J. Priyanga

Address of Applicant :Assistant Professor Vels Institute of Science, Technology and Advance studies, Vclan Nagar, PV Vaithiyalingam Road, Pallavaram, Chennai- 600117

9)Mr. Pavan Kumar Krosuri

Address of Applicant :Associate Professor Department of Pharmaceutics Santhiram College of Pharmacy, Nerawada, NH40, Nandyal district, Nandyal Pincode:518 112 Andhra pradesh, India

10)Mr. Adeep Kujur

Address of Applicant :Assistant Professor University Institute of Pharmacy, Pt. Ravishankar Shukla University, Raipur, Chhattisgarh

11)Dr. Nivedita Biswas

Address of Applicant :3rd year Postgraduate in oral and maxillofacial surgery Peoples College of Dental Science and Research center, Bhopal

12)Ms. Anjali Sinha

Address of Applicant :Assistant Professor Department of Pharmaceutics, KLE College of Pharmacy, Bengaluru Constituent unit of KLE Academy of Higher Education and Research (Deemed to be University), Rajajinagar 560010 Karnataka, India

(57) Abstract :

A method of modulation of drug release from ph-responsive soft nanoconposites. The particle comprises charged particle, polymer electret, therapeutic agent, non-viral gene vector, virion, polymorph or super absorbent polymer. The therapeutic agent are selected from medicine, medicament, dressing agent, correctives, therapy, treatment and their combination. The ingestible substance includes a substance having poor solubility, wherein the core comprises a material selected from starch, lactose, sucrose, cellulose, cellulose ether, and mixtures thereof. Admixing inorganic capping agents in a first solvent and nanoparticles-in a second solvent together to form the colloidal material, wherein the second solvent is appreciably immiscible in the first solvent. The one or more drugs are released from said drug delivery contact lens in an effective amount to treat or prevent a disease, disorder, or condition of a subject. The polymeric matrix is compounded to release the therapeutic agent from the polymeric matrix at an initial release rate.

No. of Pages : 15 No. of Claims : 1

The Patent Office Journal No. 47/2022 Dated 25/11/2022

74098



Principal
KLE College of Pharmacy
Bengaluru-560 010

(12) PATENT APPLICATION PUBLICATION

(21) Application No. 202241060573 A

(19) INDIA

(22) Date of filing of Application : 22/10/2022

(43) Publication Date : 28/10/2022

(54) Title of the invention : SYNTHESIS OF SUBSTITUTED FIVE-MEMBERED HETEROCYCLIC COMPOUNDS (PYRAZOLE, TRIAZOLE, AND IMIDAZOLE) AS POTENT INHIBITORS OF MYCOBACTERIUM TUBERCULOSIS

(51) International classification A61K0031496000, A61K0031470000, A61K0031496500, A61K0031495000, A61K0031538300

(86) International Application No. (PCT) 01/01/1900

(87) International Publication No. : NA

(61) Patent of Addition to Application Number : NA

(62) Divisional to Application Number : NA

(71) Name of Applicant :
 1) Dr. Santosh Kumar Verma
 Address of Applicant : Associate Professor School of Chemistry and Chemical Engineering, Yulin University, Yulin 719000, Shaanxi, P. R. China
 2) Mrs. Shilpa Murthy
 3) Dr. Arun Kumar Kashyap
 4) Mrs. Shilpa Shukla
 5) Mr. Rajees Kumar Mishra
 6) Mr. Tapas Panigrahi
 7) Ms. Sonal Guntam
 8) Mrs. Rekha S
 9) Mr. Rohit Singh
 10) Dr. Sonal Dubey
 11) Dr. Rameshwari Verma
 12) Dr. Kadalipara P. Rakesh
 Name of Applicant : NA
 Address of Applicant : NA

(72) Name of Inventor :
 1) Dr. Santosh Kumar Verma
 Address of Applicant : Associate Professor School of Chemistry and Chemical Engineering, Yulin University, Yulin 719000, Shaanxi, P. R. China
 2) Mrs. Shilpa Murthy
 Address of Applicant : Assistant Professor Department of Pharmaceutical Chemistry, KLE College of Pharmacy, Bengaluru, Constituent unit of KLE Academy of higher education and research (Licensed to be University), Rajanagar, 560010, Karnataka, India
 3) Dr. Arun Kumar Kashyap
 Address of Applicant : Assistant Professor, Govt. E. Rajawandara Rao PG Science College, Hulsur
 4) Mrs. Shilpa Shukla
 Address of Applicant : Assistant Professor, Tagore Institute of Pharmacy and Research, Srirangapatna, Karnataka
 5) Mr. Rajees Kumar Mishra
 Address of Applicant : Associate Professor, Shri. Hanuramma College of Pharmacy, Karhi, Sarma, 405601, Madhya Pradesh, India
 6) Mr. Tapas Panigrahi
 Address of Applicant : Associate Professor, Royal College of Pharmacy, Raipur, Chhattisgarh, India
 7) Ms. Sonal Guntam
 Address of Applicant : Assistant Professor, Shri. Hanuramma College of Pharmacy, Karhi, Sarma, 405601, Madhya Pradesh, India
 8) Mrs. Rekha S
 Address of Applicant : Assistant Professor Department of Pharmaceutical Chemistry College of Pharmaceutical Sciences Dayananda Sagar University Bengaluru 560078
 9) Mr. Rohit Singh
 Address of Applicant : Associate Professor, Shri. Sarvesh College of Pharmacy, Uperdahia, Hamirya, Prayagraj, 221503, Uttar Pradesh, India
 10) Dr. Sonal Dubey
 Address of Applicant : Professor Department of Pharmaceutical Chemistry College of Pharmaceutical Sciences Dayananda Sagar University Bengaluru Karnataka 560078
 11) Dr. Rameshwari Verma
 Address of Applicant : Associate Professor School of Chemistry and Chemical Engineering, Yulin University, Yulin 719000, Shaanxi, P. R. China
 12) Dr. Kadalipara P. Rakesh
 Address of Applicant : Department of Radiology, Biomedical Research Imaging Center, University of North Carolina at Chapel Hill, Chapel Hill, North Carolina 27599, USA

(57) Abstract
 ABSTRACT SYNTHESIS OF SUBSTITUTED FIVE-MEMBERED HETEROCYCLIC COMPOUNDS (PYRAZOLE, TRIAZOLE, AND IMIDAZOLE) AS POTENT INHIBITORS OF MYCOBACTERIUM TUBERCULOSIS A method of synthesis of substituted five-membered heterocyclic compounds as potent inhibitors of mycobacterium tuberculosis. The first therapeutic agent is selected from garflouxacin, ofloxacin, kasronycin, amikacin. The second therapeutic agent is selected from ethambutol, pyrazinamide, isoniazid, levofloxacin, moxifloxacin. Compound I of a pharmaceutically acceptable salt thereof, and a pharmaceutically acceptable diluent or carrier. Administering an effective amount of a compound, prodrug, or pharmaceutically acceptable salt therapeutically-effective amount of an active compound and a pharmaceutically-acceptable carrier, said active compound selected from a family of compounds. FIG 1

No. of Pages : 14 No. of Claims : 1



Principal
 KLE College of Pharmacy
 Bengaluru-560 010



INTELLECTUAL
PROPERTY INDIA

PATENTS | DESIGNS | TRADE MARKS
GEOGRAPHICAL INDICATIONS



सत्यमेव जयते

भारत सरकार
GOVERNMENT OF INDIA

पेटेंट कार्यालय
THE PATENT OFFICE

पेटेंट प्रमाणपत्र
PATENT CERTIFICATE
(Rule 74 of The Patents Rules)

क्रमांक : 044153572
SL No :



पेटेंट सं. / Patent No. : 431860
आवेदन सं. / Application No. : 202241032591
फाइल करने की तारीख / Date of Filing : 07/06/2022
पेटेंटी / Patentee : 1.Dr Deepa Metgud 2.Miss. Simran Sutar 3.Mr. Sreyash Gandage

प्रमाणित किया जाता है कि पेटेंटी को, उपरोक्त आवेदन में यथाप्रकटित DESIGNING AND DEVELOPMENT OF MECHANICAL PERCUSSOR DEVICE FOR BRONCHIAL HYGIENE नामक आविष्कार के लिए, पेटेंट अधिनियम, 1970 के उपबंधों के अनुसार आज तारीख जून 2022 के सातवें दिन से बीस वर्ष की अवधि के लिए पेटेंट अनुदत्त किया गया है।

It is hereby certified that a patent has been granted to the patentee for an invention entitled DESIGNING AND DEVELOPMENT OF MECHANICAL PERCUSSOR DEVICE FOR BRONCHIAL HYGIENE as disclosed in the above mentioned application for the term of 20 years from the 7th day of June 2022 in accordance with the provisions of the Patents Act,1970.



अनुदान की तारीख : 16/05/2023
Date of Grant :

पेटेंट नियंत्रक
Controller of Patent

टिप्पणी - इस पेटेंट के नवीकरण के लिए फीस, यदि इसे बनाए रखा जाना है, जून 2024 के सातवें दिन को और उसके पश्चात प्रत्येक वर्ष में उसी दिन देय होगी।

Note. - The fees for renewal of this patent, if it is to be maintained will fall / has fallen due on 7th day of June 2024 and on the same day in every year thereafter.



पेटेंट कार्यालय, भारत सरकार **The Patent Office, Government Of India**
पेटेंट प्रमाण पत्र **Patent Certificate**

(पेटेंट नियमावली का नियम 74) (Rule 74 of The Patents Rules)

पेटेंट सं. / Patent No. 470398

आवेदन सं. / Application No. 201841033950

फाइल करने की तारीख / Date of Filing 10/09/2018

पेटेंटी / Patentee 1. Dr. JORIDA FERNANDES 2. UNNATI SETTY 3. RIYA TOTHE

प्रमाणित किया जाता है कि पेटेंटी को, उपरोक्त आवेदन में यथाप्रकटित **DEVELOPMEENT OF AN ASSESSMENT AND REHABILITATION DEVICE FOR SHOULDER DYSFUNCTION** नामक आविष्कार के लिए, पेटेंट अधिनियम, 1970 के उपबंधों के अनुसार आज तारीख सितम्बर 2018 के दसवें दिन से बीस वर्ष की अवधि के लिए पेटेंट अनुदत्त किया गया है।

It is hereby certified that a patent has been granted to the patentee for an invention entitled **DEVELOPMEENT OF AN ASSESSMENT AND REHABILITATION DEVICE FOR SHOULDER DYSFUNCTION** as disclosed in the above mentioned application for the term of 20 years from the 10th day of September 2018 in accordance with the provisions of the Patents Act,1970.



[Signature]

अनुदान की तारीख : 20/11/2023 पेटेंट नियंत्रक
Date of Grant : Controller of Patents

टिप्पणी - इस पेटेंट के नवीकरण के लिए फीस, यदि इसे बनाए रखा जाना है, सितम्बर 2020 के दसवें दिन को और उसके पश्चात प्रत्येक वर्ष में उसी दिन देय होगी।
Note - The fees for renewal of this patent, if it is to be maintained, will fall / has fallen due on 10th day of September 2020 and on the same day in every year thereafter.

(12) PATENT APPLICATION PUBLICATION

(21) Application No.202341029217 A

(19) INDIA

(22) Date of filing of Application :21/04/2023

(43) Publication Date : 05/05/2023

(54) Title of the invention : Bluetooth-enabled, Lightweight, Portable, Inverted CPM machine with Mobile Interface for Post-Knee Replacement Rehabilitation

(51) International classification :A61H 010200, G06Q 203200, H04W 041800, H04W 402400, H04W 720400

(86) International Application No :PCT//
Filing Date :01/01/1900

(87) International Publication No : NA

(61) Patent of Addition to Application Number :NA
Filing Date :NA

(62) Divisional to Application Number :NA
Filing Date :NA

(71)Name of Applicant :

1)Dr. Sanjay B. Ankali

Address of Applicant :KLE College of Engineering and Technology, Department of Computer Science & Engineering, Chikodi, Karnataka,India - 591201. Chikodi -----

2)Dr. Varun Naik

3)Dr. Deepa C. Metgud

4)Dr. Prasad B. Rampure

Name of Applicant : NA

Address of Applicant : NA

(72)Name of Inventor :

1)Dr. Sanjay B. Ankali

Address of Applicant :KLE College of Engineering and Technology, Department of Computer Science & Engineering, Chikodi, Karnataka,India - 591201. Chikodi -----

2)Dr. Varun Naik

Address of Applicant :Plot No. 32, Sector 3, Shivabasava Nagar, Belagavi-590010 Belagavi -----

3)Dr. Deepa C. Metgud

Address of Applicant :F-4, The Embassy Apartment, Jadhav Nagar, Belagavi-590010 Belagavi -----

4)Dr. Prasad B. Rampure

Address of Applicant :Principal Quarters, Banantikodi Road, KLE College of Engineering and Technology, Chikodi-591201 Chikodi -----

5)Aditya Shidlyali

Address of Applicant :2784B, Kumbar Galli, Sankeshwar, Karnataka,

		Contact No.	9880088400
3B. CATEGORY OF APPLICANT(S)[Please tick (ü) at the appropriate category]			
Natural Person (√)		OtherthanNaturalPerson	
SmallEntity()		Startup()	Others()
4. INVENTOR(S) [Please tick(✓) at the appropriate category]			
Are all the inventor(s) same as the applicant(s) named above?		Yes (√)	No ()
If "No", furnish the details of the inventor(s)			
Name in Full	Nationality	Country of Residence	Address of the Inventor
5. TITLE OF THE INVENTION			
DESIGN OF ASTHETIC FUNCTIONAL ORTHOSIS FOR ULNAR DRIFT IN RHEUMATOID ARTHRITIS			
6. AUTHORISED REGISTERED PATENT AGENT(S)		IN/PA No.	NA
		Name	NA
		MobileNo.	NA
7. ADDRESS FOR SERVICE OF APPLICANT IN INDIA	Name	DR. SANTOSH METGUD¹, DR. PAMELA D'SILVA², DR. AMBARIN PIRJADE³	
	Postal Address	¹PROFESSOR, DEPARTMENT OF ORTHOPAEDIC MANUAL THERAPY, KLE ACADEMY OF HIGHER EDUCATION AND RESEARCH, INSTITUTE OF PHYSIOTHERAPY, JNMC CAMPUS NEHRU NAGAR, BELAGAVI-590010	
		²ASSISTANT PROFESSOR, DEPARTMENT OF ORTHOPAEDIC MANUAL THERAPY, KLE ACADEMY OF HIGHER EDUCATION AND RESEARCH, INSTITUTE OF PHYSIOTHERAPY, JNMC CAMPUS NEHRU NAGAR, BELAGAVI-590010	
		³2nd YEAR MPT, DEPARTMENT OF ORTHOPAEDIC MANUAL THERAPY, KLE ACADEMY OF HIGHER EDUCATION AND RESEARCH, INSTITUTE OF PHYSIOTHERAPY, BELAGAVI - 590010	
	TelephoneNo.		
	MobileNo.	¹ (+91) 9880088400, ²(+91)7353594793, ³(+91) 7972728870	
	FaxNo.	0831-2474727	
E-mailID	¹santoshmetgud@kleipt.edu.in, ²pamela.dsilva@ymail.com , ³ambarin66@gmail.com		
8. IN CASE OF APPLICATION CLAIMING PRIORITY OF APPLICATION FILED IN CONVENTION COUNTRY, PARTICULARS OF CONVENTION APPLICATION			
Country	Application Number	Filing date	Name of the Applicant
N.A	N.A	N.A	N.A
Title of the invention		IPC (as classified in the Convention country)	
N.A		N.A	
9. IN CASE OF PCT NATIONAL PHASE APPLICATION, PARTICULARS OF INTERNATIONAL APPLICATION FILED UNDER PATENT CO-OPERATION TREATY (PCT)			
International application number		International filing date	
N.A		N.A	
10. IN CASE OF DIVISIONAL APPLICATION FILED UNDER SECTION 16, PARTICULARS OF ORIGINAL (FIRST) APPLICATION			
Original (first) application No.		Date of filing of original (first) application	
N.A		N.A	

14. यदि कार्य एक 'कलात्मक कार्य' है जो किसी भी सामान या सेवाओं के संबंध में उपयोग किया जाता है या उपयोग करने में सक्षम है, तो आवेदन में कॉपीराइट अधिनियम, 1957 की धारा 45 की उप-धारा (प) के प्रावधान के अनुसार व्यापार चिह्न पंजीयक से प्रमाणन शामिल होना चाहिए।
If the work is an 'Artistic work' which is used or capable of being used in relation to any goods or services, the application should include a certification from the Registrar of Trade Marks in terms of the provision to Sub-Section (i) of Section 45 of the Copyright Act, 1957. : N.A.
15. यदि कार्य एक 'कलात्मक कार्य' है, तो क्या यह डिजाइन अधिनियम 2000 के अंतर्गत पंजीकृत है? यदि हां, तो विवरण दें
If the work is an 'Artistic work', whether it is registered under the Designs Act 2000 if yes give details. : N.A.
16. यदि कार्य एक 'कलात्मक कार्य' है, जो डिजाइन अधिनियम 2000 के तहत एक डिजाइन के रूप में पंजीकृत होने में सक्षम है, तो क्या यह औद्योगिक प्रक्रिया के माध्यम से किसी वस्तु पर प्रयोग में लाया गया है और यदि हां, तो इसे कितनी बार पुनः प्रस्तुत किया गया है?
If the work is an 'Artistic work', capable of being registered as a design under the Designs Act 2000, whether it has been applied to an article through an industrial process and ,if yes ,the number of times it is reproduced. : N.A.
17. टिप्पणी, यदि कोई हो/Remarks, if any :
- डायरी संख्या/Diary Number: 12666/2023-CO/L
- आवेदन की तिथि/Date of Application: 15/05/2023
- प्राप्ति की तिथि/Date of Receipt: 15/05/2023




Registrar of Copyrights



Dated : 22/11/2022

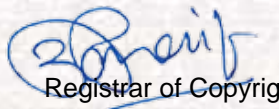
1. Registration Number : **L-118936/2022**
2. Name, address and nationality of the applicant : DR DEEPA METGUD , KAHER INSTITUTE OF PHYSIOTHERAPY-590010
INDIAN
DR ANUSH BANDODKAR , KAHER INSTITUTE OF PHYSIOTHERAPY--590010
INDIAN
DR STACY BARRETO , KAHER INSTITUTE OF PHYSIOTHERAPY-590010-590010
INDIAN
DR PRACHI BARVE , KAHER INSTITUTE OF PHYSIOTHERAPY-590010
INDIAN
3. Nature of the applicant's interest in the copyright of the work : AUTHOR
4. Class and description of the work : LITERARY/ DRAMATIC WORK DURING COVID 19 ALL THE EDUCATION SYSTEM WERE CARRIED ONLINE AND WAS SAME FOR PHYSIOTHERAPY COLLEGES. A QUESTIONER IS DEVELOPED TO CHECK PERCEPTION OF THE SAME.
5. Title of the work : PERCEPTION OF ONLINE PHYSIOTHERAPY EDUCATION QUESTIONNAIRE DURING COVID-19 PANDEMIC.
6. Language of the work : ENGLISH
7. Name, address and nationality of the author and if the author is deceased, date of his decease : DR DEEPA METGUD , KAHER INSTITUTE OF PHYSIOTHERAPY-590010
INDIAN

DR ANUSH BANDODKAR , KAHER INSTITUTE OF PHYSIOTHERAPY--590010
INDIAN

DR STACY BARRETO , KAHER INSTITUTE OF PHYSIOTHERAPY-590010-590010
INDIAN

DR PRACHI BARVE , KAHER INSTITUTE OF PHYSIOTHERAPY-590010
INDIAN
8. Whether the work is published or unpublished : UNPUBLISHED
9. Year and country of first publication and name, address and nationality of the publisher : N.A.
10. Years and countries of subsequent publications, if any, and names, addresses and nationalities of the publishers : N.A.
11. Names, addresses and nationalities of the owners of various rights comprising the copyright in the work and the extent of rights held by each, together with particulars of assignments and licences, if any : KAHER INSTITUTE OF PHUSIOTHERAPY , JNMC CAMPUS , NEHRU NAGAR, BELGAVI, KARNATAKA-590010
INDIAN
12. Names, addresses and nationalities of other persons, if any, authorised to assign or licence of rights comprising the copyright : DR DEEPA METGUD , KAHER INSTITUTE OF PHYSIOTHERAPY-590010
INDIAN
DR ANUSH BANDODKAR , KAHER INSTITUTE OF PHYSIOTHERAPY--590010
INDIAN
DR STACY BARRETO , KAHER INSTITUTE OF PHYSIOTHERAPY-590010-590010
INDIAN
DR PRACHI BARVE , KAHER INSTITUTE OF PHYSIOTHERAPY-590010
INDIAN
13. Name of the work, the location of the original work, and nationality of the person in possession of an architectural work, the year of work should also be shown). : N.A.
14. If the work is an 'Artistic work' which is used or capable of being used in relation to any goods or services, the application should include a certification from the Registrar of Trade Marks in terms of the provision to Sub-Section (i) of Section 45 of the Copyright Act, 1957. : N.A.
15. If the work is an 'Artistic work', whether it is registered under the Designs Act 2000 if yes give details. : N.A.




Registrar of Copyrights

16. If the work is an 'Artistic work', capable of being registered as a design under the Designs Act 2000.whether it has been applied to an article through an industrial process and ,if yes ,the number of times it is reproduced. : N.A.

17. Remarks, if any : 0

Diary Number : 12559/2022-CO/L

Date of Application : 14/06/2022

Date of Receipt : 14/06/2022




Registrar of Copyrights

आवेदन की तिथि/Date of Application: 22/06/2023
प्राप्ति की तिथि/Date of Receipt: 22/06/2023




Registrar of Copyrights

16. यदि कार्य एक 'कलात्मक कार्य' है, जो डिजाइन अधिनियम 2000 के तहत एक डिजाइन के रूप में पंजीकृत होने में सक्षम है, तो क्या यह औद्योगिक प्रक्रिया के माध्यम से किसी वस्तु पर प्रयोग में लाया गया है और यदि हाँ, तो इसे कितनी बार पुनः प्रस्तुत किया गया है? : N.A.
If the work is an 'Artistic work', capable of being registered as a design under the Designs Act 2000.whether it has been applied to an article through an industrial process and ,if yes ,the number of times it is reproduced.

17. टिप्पणी, यदि कोई हो/Remarks, if any :

डायरी संख्या/Diary Number: 16340/2022-CO/L
आवेदन की तिथि/Date of Application: 30/07/2022
प्राप्ति की तिथि/Date of Receipt: 30/07/2022




Registrar of Copyrights



Extracts from the Register of Copyrights



प्रतिलिप्यधिकार कार्यालय, भारत सरकार | Copyright Office, Government Of India

दिनांक/Dated:30/08/2023

- पंजीकरण संख्या/Registration Number : **L-132653/2023**
- आवेदक का नाम, पता तथा राष्ट्रीयता
Name, address and nationality of the applicant : **NAGMA KHAN , KAHER INSTITUTE OF PHYSIOTHERAPY, NEHRU NAGAR BELAGAVI-590010 INDIAN**
- कृति के प्रतिलिप्यधिकार में आवेदक के हित की प्रकृति
Nature of the applicant's interest in the copyright of the work : **OWNER**
- कृति का वर्ग और वर्णन
Class and description of the work : **LITERARY/ DRAMATIC WORK IT IS A BOOKLET DESIGNED TO EDUCATE YOUNG GIRLS ABOUT MENSTRUAL KNOWLEDGE, HYGIENE AND PRACTICES AND ALSO THE MYTHS AND TABOOS REGARDING MENSTRUATION.**
- कृति का शीर्षक
Title of the work : **MENSTRUAL HEALTH, HYGIENE AND RESTRICTIONS IN ADOLESCENT GIRLS.**
- कृति की भाषा
Language of the work : **ENGLISH, HINDI, KANNADA**
- रचयिता का नाम, पता और राष्ट्रीयता तथा यदि रचयिता की मृत्यु हो गई है, तो मृत्यु की तिथि
Name, address and nationality of the author and if the author is deceased, date of his decease : **NAGMA KHAN , KAHER INSTITUTE OF PHYSIOTHERAPY, NEHRU NAGAR BELAGAVI-590010 INDIAN**
- कृति प्रकाशित है या अप्रकाशित
Whether the work is published or unpublished : **UNPUBLISHED**
- प्रथम प्रकाशन का वर्ष और देश तथा प्रकाशक का नाम, पता और राष्ट्रीयता
Year and country of first publication and name, address and nationality of the publisher : **N.A.**
- बाद के प्रकाशनों के वर्ष और देश, यदि कोई हों, और प्रकाशकों के नाम, पते और राष्ट्रीयताएँ
Years and countries of subsequent publications, if any, and names, addresses and nationalities of the publishers : **N.A.**
- कृति में प्रतिलिप्यधिकार सहित विभिन्न अधिकारों के स्वामियों के नाम, पते और राष्ट्रीयताएँ और समनुदेशन और अनुज्ञापितियों के विवरण के साथ प्रत्येक के अधिकार का विस्तार, यदि कोई हो।
Names, addresses and nationalities of the owners of various rights comprising the copyright in the work and the extent of rights held by each, together with particulars of assignments and licences, if any : **NAGMA KHAN , KAHER INSTITUTE OF PHYSIOTHERAPY, NEHRU NAGAR BELAGAVI-590010 INDIAN**
DR ARATI MAHISHALE , KAHER INSTITUTE OF PHYSIOTHERAPY, NEHRU NAGAR, BELAGAVI-590010 INDIAN
- अन्य व्यक्तियों के नाम, पते और राष्ट्रीयताएँ, यदि कोई हों, जो प्रतिलिप्यधिकार वाले अधिकारों को समनुदेशित करने या अनुज्ञापित देने के लिए अधिकृत हों
Names, addresses and nationalities of other persons, if any, authorised to assign or licence of rights comprising the copyright : **N.A.**
- यदि कृति एक 'कलात्मक कृति' है, तो कृति पर अधिकार रखने वाले व्यक्ति का नाम, पता और राष्ट्रीयता सहित मूल कृति का स्थान। (एक वास्तुशिल्प कृति के मामले में कृति पूरी होने का वर्ष भी दिखाया जाना चाहिए)
If the work is an 'Artistic work', the location of the original work, including name, address and nationality of the person in possession of the work. (In the case of an architectural work, the year of completion of the work should also be shown). : **N.A.**
- यदि कृति एक 'कलात्मक कृति' है जो किसी भी माल या सेवाओं के संबंध में उपयोग की जाती है या उपयोग किए जाने में सक्षम है, तो आवेदन में प्रतिलिप्यधिकार अधिनियम, 1957 की धारा 45 की उप-धारा (i) के प्रावधान के अनुसार व्यापार चिह्न रजिस्ट्रार से प्रमाणन शामिल होना चाहिए।
If the work is an 'Artistic work' which is used or capable of being used in relation to any goods or services, the application should include a certification from the Registrar of Trade Marks in terms of the provision to Sub-Section (i) of Section 45 of the Copyright Act, 1957. : **N.A.**
- यदि कृति एक 'कलात्मक कृति' है, तो क्या यह डिजाइन अधिनियम 2000 के अंतर्गत पंजीकृत है? यदि हाँ, तो विवरण दें।
If the work is an 'Artistic work', whether it is registered under the Designs Act 2000, if yes give details. : **N.A.**
- यदि कृति एक 'कलात्मक कृति' है, जो डिजाइन अधिनियम 2000 के तहत एक डिजाइन के रूप में पंजीकृत होने में सक्षम है, तो क्या यह औद्योगिक प्रक्रिया के माध्यम से किसी वस्तु पर प्रयुक्त की गई है और यदि हाँ, तो इसे कितनी बार पुनरुत्पादित किया गया है?
If the work is an 'Artistic work', capable of being registered as a design under the Designs Act 2000, whether it has been applied to an article though an industrial process and ,if yes ,the number of times it is reproduced. : **N.A.**
- टिप्पणी, यदि कोई हो/Remarks, if any : **N.A.**

डायरी संख्या/Diary Number: 21803/2022-CO/L

आवेदन की तिथि/Date of Application: 17/10/2022

प्राप्ति की तिथि/Date of Receipt: 17/10/2022



[Signature]
Registrar of Copyrights



Extracts from the Register of Copyrights



प्रतिलिप्यधिकार कार्यालय, भारत सरकार | Copyright Office, Government Of India

दिनांक/Dated:29/11/2023

1. पंजीकरण संख्या/Registration Number

L-136896/2023

2. आवेदक का नाम, पता तथा राष्ट्रीयता
Name, address and nationality of the applicant

AAARTI WELLING , DEPT. OF ORTHOPEDIC PHYSIOTHERAPY, KLE INSTITUTE OF PHYSIOTHERAPY, NEHRU NAGAR-590010 INDIAN

वैयक्तिक/Personal

VIJAY KAGE , DEPT. OF ORTHOPEDIC PHYSIOTHERAPY, KLE INSTITUTE OF PHYSIOTHERAPY, NEHRU NAGAR-590010-590010 INDIAN

वैयक्तिक/Personal

PEEYOOSHA GURUDUT , DEPT. OF ORTHOPEDIC PHYSIOTHERAPY, KLE INSTITUTE OF PHYSIOTHERAPY, NEHRU NAGAR-590010 INDIAN

वैयक्तिक/Personal

NIKITA MEHTA , DEPT. OF ORTHOPEDIC PHYSIOTHERAPY, KLE INSTITUTE OF PHYSIOTHERAPY, NEHRU NAGAR-590010 INDIAN

वैयक्तिक/Personal

ANJALI PUNJANI , DEPT. OF ORTHOPEDIC PHYSIOTHERAPY, KLE INSTITUTE OF PHYSIOTHERAPY, NEHRU NAGAR-590010 INDIAN

वैयक्तिक/Personal

SUSHMITA BADIGER , DEPT. OF ORTHOPEDIC PHYSIOTHERAPY, KLE INSTITUTE OF PHYSIOTHERAPY, NEHRU NAGAR-590010 INDIAN

वैयक्तिक/Personal

वैयक्तिक/Personal

वैयक्तिक/Personal

वैयक्तिक/Personal

वैयक्तिक/Personal

वैयक्तिक/Personal

3. कृति के प्रतिलिप्यधिकार में आवेदक के हित की प्रकृति
Nature of the applicant's interest in the copyright of the work

AUTHOR

4. कृति का वर्ग और वर्णन
Class and description of the work

LITERARY/ DRAMATIC WORK ORAL AND MAXILLOFACIAL SURGERIES ARE THE MOST RAPIDLY EXPANDING DENTISTRY SPECIALTY WHICH HAVE BEEN USED TO TREAT VARIOUS DISEASES, INJURIES, AND DEFECTS AROUND THE ORAL AND MAXILLOFACIAL REGION.

वैयक्तिक/Personal

वैयक्तिक/Personal

वैयक्तिक/Personal

KWAMPS COMPREHENSIVE PHYSIOTHERAPY PROTOCOL FOR POST-OPERATIVE ORAL AND MAXILLOFACIAL SURGERIES

वैयक्तिक/Personal

वैयक्तिक/Personal

6. कृति की भाषा
Language of the work

ENGLISH

वैयक्तिक/Personal

वैयक्तिक/Personal

वैयक्तिक/Personal

वैयक्तिक/Personal

वैयक्तिक/Personal

वैयक्तिक/Personal

वैयक्तिक/Personal

वैयक्तिक/Personal

वैयक्तिक/Personal

वैयक्तिक/Personal

वैयक्तिक/Personal

वैयक्तिक/Personal

वैयक्तिक/Personal

वैयक्तिक/Personal

वैयक्तिक/Personal

वैयक्तिक/Personal

वैयक्तिक/Personal

वैयक्तिक/Personal

वैयक्तिक/Personal

वैयक्तिक/Personal

वैयक्तिक/Personal

वैयक्तिक/Personal

वैयक्तिक/Personal

वैयक्तिक/Personal

वैयक्तिक/Personal

वैयक्तिक/Personal

वैयक्तिक/Personal

वैयक्तिक/Personal

वैयक्तिक/Personal

वैयक्तिक/Personal

वैयक्तिक/Personal

वैयक्तिक/Personal

वैयक्तिक/Personal

वैयक्तिक/Personal

वैयक्तिक/Personal

वैयक्तिक/Personal

वैयक्तिक/Personal

वैयक्तिक/Personal

वैयक्तिक/Personal

वैयक्तिक/Personal

वैयक्तिक/Personal

वैयक्तिक/Personal

वैयक्तिक/Personal

वैयक्तिक/Personal



Registrar of Copyrights

11. कृति में प्रतिलिप्यधिकार सहित विभिन्न अधिकारों के स्वामियों के नाम, पते और :
राष्ट्रीयताएं और समनुदेशन और अनुज्ञप्तियों के विवरण के साथ प्रत्येक के
अधिकार का विस्तार, यदि कोई हो।
Names, addresses and nationalities of the owners of various rights
comprising the copyright in the work and the extent of rights held
by each, together with particulars of assignments and licences, if
any
- AARTI WELLING , DEPT. OF ORTHOPEDIC
PHYSIOTHERAPY, KLE INSTITUTE OF PHYSIOTHERAPY,
NEHRU NAGAR-590010
INDIAN
VIJAY KAGE , DEPT. OF ORTHOPEDIC PHYSIOTHERAPY,
KLE INSTITUTE OF PHYSIOTHERAPY, NEHRU NAGAR-
590010-590010
INDIAN
PEEYOOSHA GURUDUT , DEPT. OF ORTHOPEDIC
PHYSIOTHERAPY, KLE INSTITUTE OF PHYSIOTHERAPY,
NEHRU NAGAR-590010
INDIAN
NIKITA MEHTA , DEPT. OF ORTHOPEDIC
PHYSIOTHERAPY, KLE INSTITUTE OF PHYSIOTHERAPY,
NEHRU NAGAR-590010
INDIAN
ANJALI PUNJANI , DEPT. OF ORTHOPEDIC
PHYSIOTHERAPY, KLE INSTITUTE OF PHYSIOTHERAPY,
NEHRU NAGAR-590010
INDIAN
SUSHMITA BADIGER , DEPT. OF ORTHOPEDIC
PHYSIOTHERAPY, KLE INSTITUTE OF PHYSIOTHERAPY,
NEHRU NAGAR-590010
INDIAN
12. अन्य व्यक्तियों के नाम, पते और राष्ट्रीयताएं, यदि कोई हों, जो प्रतिलिप्यधिकार :
वाले अधिकारों को समनुदेशित करने या अनुज्ञप्ति देने के लिए अधिकृत हों
Names, addresses and nationalities of other persons, if any,
authorised to assign or licence of rights comprising the copyright
- DEPT. OF ORTHOPEDIC PHYSIOTHERAPY , DEPT. OF
ORTHOPEDIC PHYSIOTHERAPY, KLE INSTITUTE OF
PHYSIOTHERAPY,
NEHRU NAGAR-590010
INDIAN
13. यदि कृति एक 'कलात्मक कृति' है, तो कृति पर अधिकार रखने वाले व्यक्ति का :
नाम, पता और राष्ट्रीयता सहित मूल कृति का स्थान। (एक वास्तुशिल्प कृति
के मामले में कृति पूरी होने का वर्ष भी दिखाया जाना चाहिए)
If the work is an 'Artistic work', the location of the original work,
including name, address and nationality of the person in possession
of the work. (In the case of an architectural work, the year of
completion of the work should also be shown).
- N.A.
14. यदि कृति एक 'कलात्मक कृति' है जो किसी भी माल या सेवाओं के संबंध में :
उपयोग की जाती है या उपयोग किए जाने में सक्षम है, तो आवेदन में
प्रतिलिप्यधिकार अधिनियम, 1957 की धारा 45 की उप-धारा (i) के प्रावधान के
अनुसार व्यापार चिह्न रजिस्ट्रार से प्रमाणन शामिल होना चाहिए।
If the work is an 'Artistic work' which is used or capable of being
used in relation to any goods or services, the application should
include a certification from the Registrar of Trade Marks in terms of
the provision to Sub-Section (i) of Section 45 of the Copyright Act,
1957.
- N.A.
15. यदि कृति एक 'कलात्मक कृति' है, तो क्या यह डिजाइन अधिनियम 2000 के :
अंतर्गत पंजीकृत है? यदि हां, तो विवरण दें।
If the work is an 'Artistic work', whether it is registered under the
Designs Act 2000, if yes give details.
- N.A.
16. यदि कृति एक 'कलात्मक कृति' है, जो डिजाइन अधिनियम 2000 के तहत :
एक डिजाइन के रूप में पंजीकृत होने में सक्षम है, तो क्या यह औद्योगिक
प्रक्रिया के माध्यम से किसी वस्तु पर प्रयुक्त की गई है और यदि हां, तो इसे
कितनी बार पुनरुत्पादित किया गया है?
If the work is an 'Artistic work', capable of being registered as a
design under the Designs Act 2000.whether it has been applied to an
article though an industrial process and ,if yes ,the number of times
it is reproduced.
- N.A.
17. टिप्पणी, यदि कोई हो/Remarks, if any :
- डायरी संख्या/Diary Number: 17591/2023-CO/L
- आवेदन की तिथि/Date of Application: 04/07/2023
- प्राप्ति की तिथि/Date of Receipt: 04/07/2023



(Signature)
Registrar of Copyrights

1923	19075/2023-CO/A	A-147632/2023	28-08-2023	ROOTS HEALTHCARE (LABEL)	Artistic	VINAY VERMA
1924	17723/2023-CO/A	A-147646/2023	28-08-2023	WHAT ,As per label	Artistic	HIMANSHU KUMAR
1925	18616/2023-CO/L	L-132460/2023	28-08-2023	Kiara's Joys Of The Week	Literary/ Dramatic	ANKIT AGGARWAL
1926	17911/2023-CO/L	L-132518/2023	28-08-2023	Blood Salute	Literary/ Dramatic	AKB. KUMAR
1927	17587/2023-CO/L	L-132475/2023	28-08-2023	Quadricore exercise protocol to train the myofascial slings	Literary/ Dramatic	AARTI WELLING ,KEERTANA VAIDYANATHAN ,PEEYOOSHA GURUDUT ,VIJAY KAGE
1928	17774/2023-CO/L	L-132517/2023	28-08-2023	Kiara In Her Garden	Literary/ Dramatic	ANKIT AGGARWAL
1929	18585/2023-CO/A	A-147631/2023	28-08-2023	BENITTON	Artistic	RAJARAM MANGALARAM PRAJAPATI
1930	18233/2023-CO/L	L-132513/2023	28-08-2023	The Facts That Bowled Me Over	Literary/ Dramatic	REKHA SINGH
1931	18525/2023-CO/L	L-132442/2023	28-08-2023	PPAR-y for the Next Generation Cancer Chemotherapy	Literary/ Dramatic	DR. D. Y. PATIL VIDYAPEETH, PUNE - DEEMED TO BE UNIVERSITY
1932	16701/2023-CO/L	L-132466/2023	28-08-2023	THAT'S HOW IT BEGINS	Literary/ Dramatic	SREEMANTI BAG